

Integrated LED Display

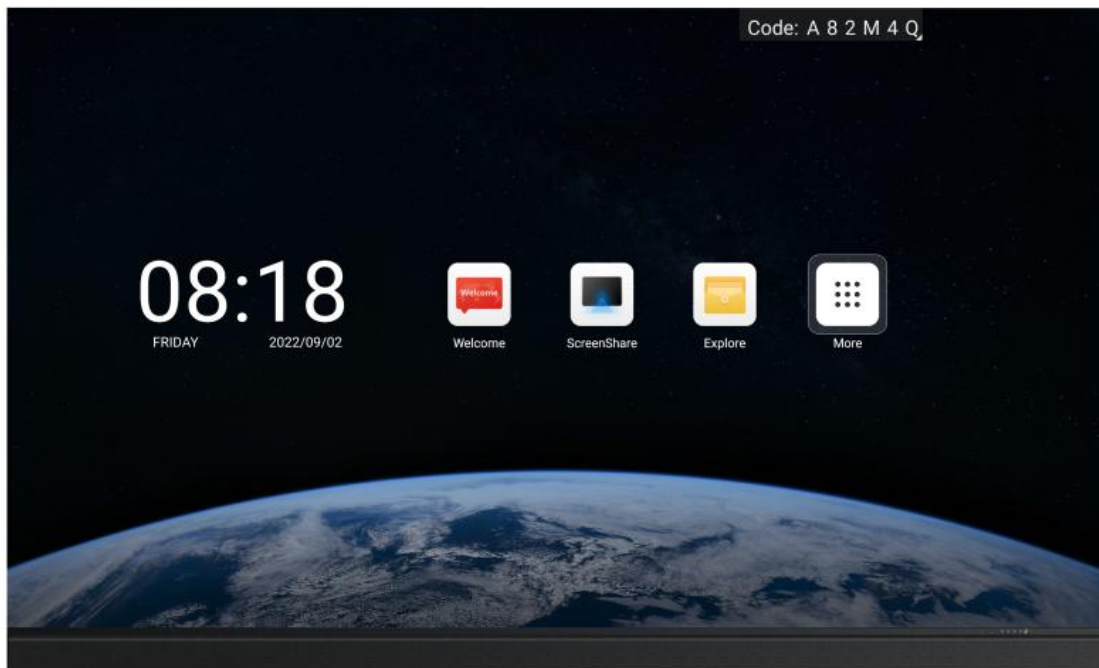

All pictures contained herein are provided for information only.

Product Operation Manual

V2.1

Contents

I.Product Introduction	6
II. Product Installation	6
III. Functions	16
IV. Function Menu	22
V. Settings Menu	26
VI. Simple Troubleshooting	33
VII. Parts Replacement	34
VIII. Special Statements	36

WARNING

This is a Class A product. In a residential environment, running this equipment may cause radio interference.

The possibility of damage to the device and the inability to recover due to ignoring the following contents of the warning is extremely high.

- 1) Do not invert and throw the equipment during handling and storage;
- 2) Do not tilt and collide to scratch the equipment during the installation process;
- 3) Do not drench and immerse the equipment in water;
- 4) Do not enable the air outlet of the air conditioner close to the display screen;
- 5) Do not place or use the display in an environment with volatile, corrosive or flammable chemicals;
- 6) Do not use the equipment in humidity above 80% or in outdoor rainy days;
- 7) Do not clean the display equipment with water and chemical solvents;
- 8) Do not use electrical accessories that are not certified by the equipment manufacturer;
- 9) It must be ensured that the display and its accessories are properly and reliably grounded before use;
- 10) If abnormality occurs in the display, such as abnormal smell, smoke, electric leakage or temperature happens, please cut off the power immediately and then contact the professional;
- 11) This device has two input sockets that need to be disconnected at the same time to disconnect the power supply from the device. The AC power for the device shall be 100-240V.
- 12) This product is an indoor product. It is strictly prohibited to use it in direct sunlight

◆NOTE!

It is highly probable that you will not be able to get the best display effect if you ignore the content of the notice.

- 1) Wear anti-static gloves and anti-static bracelet during installation and maintenance;
- 2) Smooth air flow on the back of the display must be considered when designing the heat dissipation scheme;
- 3) The storage environment of the display should be ventilated and dry, and the humidity should not exceed 85%;
- 4) Under normal circumstances, the display must be powered on and turned on at least twice a week, and each lighting time shall not less than 2 hours;
- 5) If the display is installed in the seaside, saline-alkali area, sulfur-containing gas area, places near kitchen smoke exhaust or with large indoor and outdoor temperature difference, it may cause equipment failure and affect the service life. If inevitable, please consult our professional and technical personnel;
- 6) This product is only for use at altitude not greater than 5000m.
- 7)The working environment of the display should not exceed - 10 ~ 40 °
- 8) In order to ensure long-term and more uniform display effect, do not play fixed images for a long time

MISE EN GARDE

Ce produit appartient à la classe A. Dans un environnement résidentiel, l'utilisation de cet équipement peut causer des interférences radio.

La possibilité d'endommager l'appareil et l'incapacité de récupération en raison de l'ignorance du contenu suivant d'avertissement est extrêmement élevée.

- 1) Ne pas retourner et jeter l'équipement pendant la manipulation et le stockage ;
- 2) Ne pas incliner et heurter et rayer l'équipement pendant le processus d'installation ;
- 3) Ne pas tremper et immerger l'équipement dans l'eau ;
- 4) Ne pas activer la sortie d'air du climatiseur à proximité de l'écran d'affichage ;
- 5) Ne pas placer ou utiliser l'affichage dans un environnement contenant des produits chimiques volatils, corrosifs ou inflammables ;
- 6) Ne pas utiliser l'équipement dans un milieu où l'humidité est supérieure à 80% ou pendant les jours de pluie extérieurs ;
- 7) Ne pas nettoyer pas l'équipement d'affichage avec de l'eau et des solvants chimiques ;
- 8) Ne pas utiliser d'accessoires électriques qui ne sont pas certifiés par le fabricant de l'équipement ;
- 9) Il faut s'assurer que l'écran et ses accessoires sont mis à la terre correctement et de manière fiable avant l'utilisation ;
- 10) Si une anomalie se produit sur l'écran, telle qu'une odeur anormale, de la fumée, une fuite électrique ou une température, veuillez couper immédiatement l'alimentation et contacter un professionnel ;
- 11) Ce dispositif a deux prises d'entrée qui doivent être déconnectées en même temps pour déconnecter l'alimentation du dispositif. L'alimentation en courant alternatif de l'appareil doit être de 100-240 V.
- 12) Ce produit est destiné à un usage intérieur et ne doit pas être utilisé sous la lumière directe du soleil

◆REMARQUE!

Il est fort probable que vous ne soyez pas en mesure d'obtenir le meilleur effet d'affichage si vous ignorez le contenu de l'avis.

- 1) Porter des gants antistatiques et un bracelet antistatique lors de l'installation et de l'entretien ;
- 2) Le flux d'air régulier à l'arrière de l'écran doit être pris en compte lors de la conception du schéma de dissipation thermique ;
- 3) L'environnement de stockage de l'affichage doit être ventilé et sec, et l'humidité ne doit pas dépasser 85% ;
- 4) Dans des circonstances normales, le dispositif d'affichage doit être mis sous tension et allumé au moins deux fois par semaine, et chaque durée d'allumage ne doit pas être inférieure à 2 heures ;
- 5) Si l'écran est installé en bord de mer, dans une zone saline alcaline, dans une zone gazeuse contenant du soufre, dans des endroits proches de l'évacuation de fumée de la cuisine ou dans un endroit où il y a une grande différence de température intérieure et extérieure, cela peut provoquer une défaillance de l'équipement et affecter la durée de vie. Si cela est inévitable, veuillez consulter notre personnel professionnel et technique ;
- 6) Ce produit est uniquement destiné à une utilisation à une altitude ne dépassant pas 5000m.
- 7) L'environnement de fonctionnement de l'affichage ne doit pas dépasser - 10 ~ 40 °
- 8) Afin de garantir un effet d'affichage plus uniforme à long terme, ne lisez pas d'images fixes pendant longtemps.

I.Product Introduction

(1) Product appearance

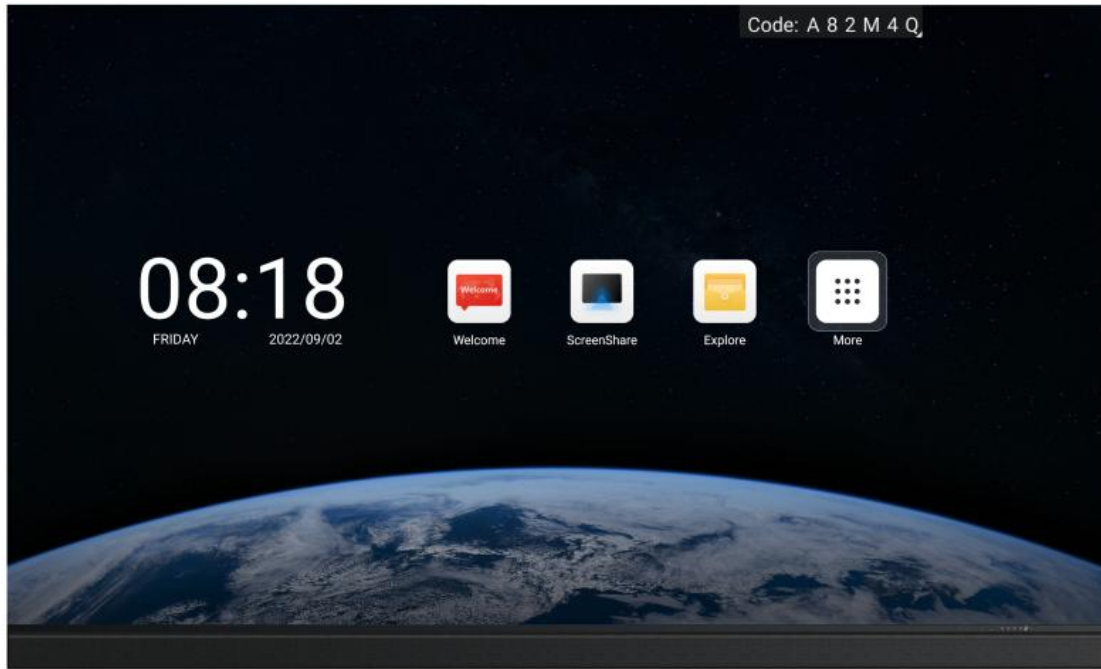

Front

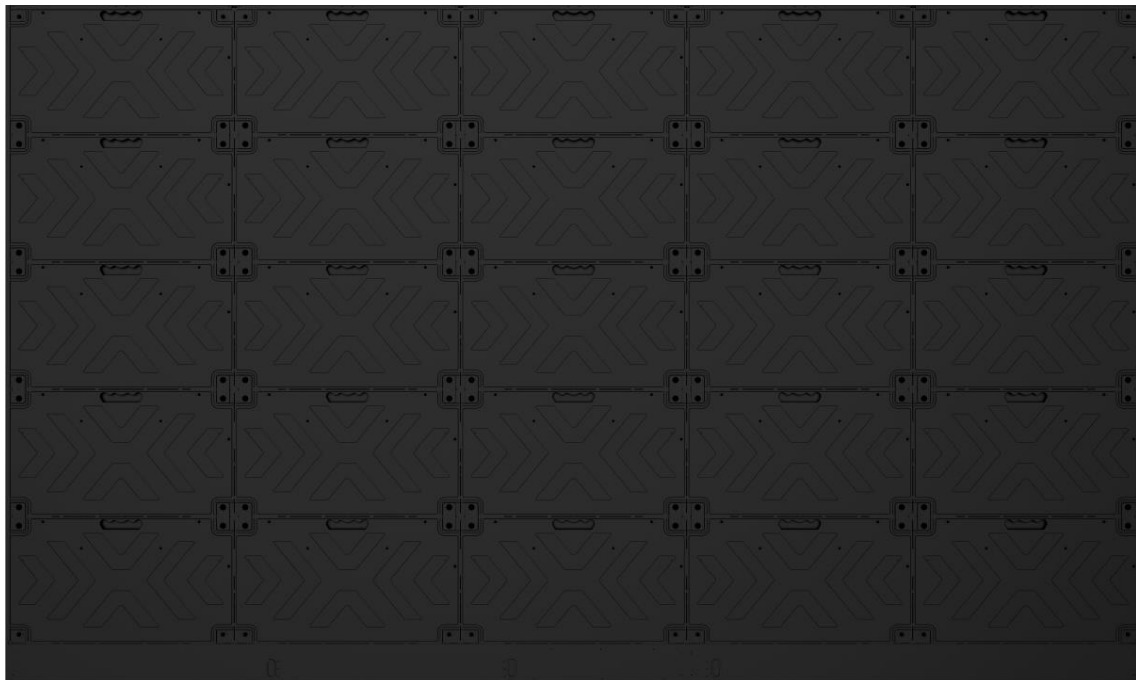

Back

*The back of the product is illustrated for the 138-inch product as an example.



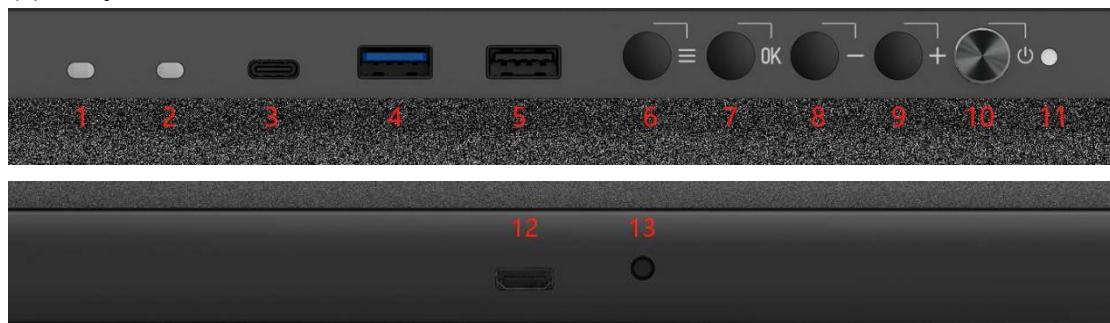





(2) Keys and interfaces



SN	Description	SN	Description
1	Light sensibility	8	1.Brightness reduction key under brightness adjustment mode; 2.Down/Minus key under menu call-up mode
2	IR	9	1.Brightness increase kry under brightness adjustment mode; 2.up/plus key under menu call-up mode
3	Type C port	10	standby/Wake-up key
4	USB 3.0 port	11	Bi-color indicator lamp (red/blue)
5	USB 2.0 port	12	HDMI input port (toward bottom)
6	Menu call-up key (incl. brightness, color temperature, contrast, sound, signal source, and test mode	13	3.5mm audio output port(toward the bottom)

	sub-menus)		
7	Menu call-up key (incl. brightness, color temperature, contrast, sound, signal source, and test mode sub-menus)	14	Built-in 2*30W stereo that supports 2.0 channels

Remote control

Icon	Description
	Standby/Wake-up
	Up
	Down
OK	Enter
	Left
	Right
+	Volume +
-	Volume -
	Return
	Brightness adjustment
	Menu
	Home screen



(4) Interface

The number of ports and type of the device are subject to the real product received. Our description here is for illustration only.

Connect HDMI input

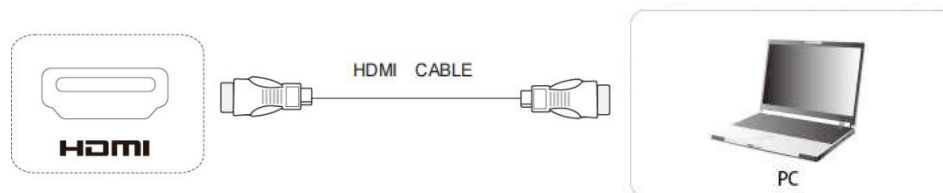

How to connect:

1. Use a HDMI cable to connect to your computer or other device having HDMI output;
2. Press the channel switch key (on the machine or remote control) to switch to the HDMI display channel.

USB input/TYPER-C input

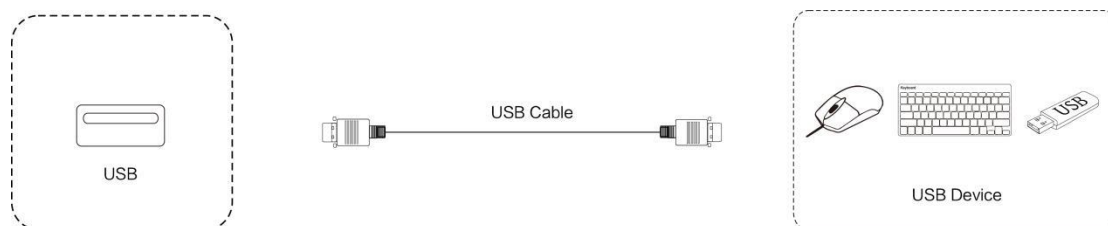

How to connect:

1. Connect the USB disk, mouse and keyboard to the USB / type-C interface;
2. The mouse and keyboard can be directly used after they are connected to the USB/TYPER-C interface;
3. To view the contents of the USB disk, enter the explorer on the system home screen and read the file.

Output video signals

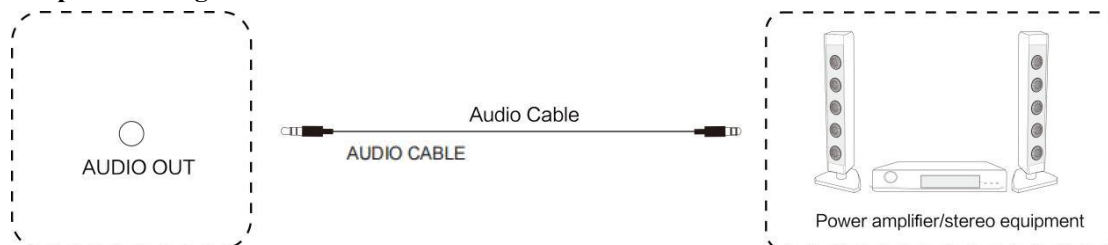

How to connect:

1. Connect one end of the audio cable to the 3.5mm audio output port and the other end to the amplifier, stereo, headphone and other devices;
2. You may use the remote control to control the volume of the audio sound outputted.

II. Product Installation

(1) Installation environment

- 1> For wall mounting, the wall should be a load-bearing structure. Installation on special wall structures such as glass, marble, porcelain, or hollow walls may result in additional cost as these structures cannot bear the weight of the product and may need special installation processes.
- 2> The installation is limited to punching the load-bearing wall, hanging, or mounting on a vertical bracket; any special installation such as wall reinforcing or steel structure installation will be subject to additional cost calculated as actually incurred;
- 3> We assume no responsibility for any potentially hazardous installation designated by you despite advice of our installer; nor shall we be held liable for any damage to any other item caused by your use of any non-MAXHUB standard/proprietary hanging bracket.

(2) Structure installation

- 1> Bracket mounting*



Bracket mounting

*The installation descriptions below are provided for the 138-inch product as an example.

Installation procedure:

Step 1: Assemble the bracket

- 1) Find the parts according to the parts breakdown of the bracket assembly, as illustrated below:

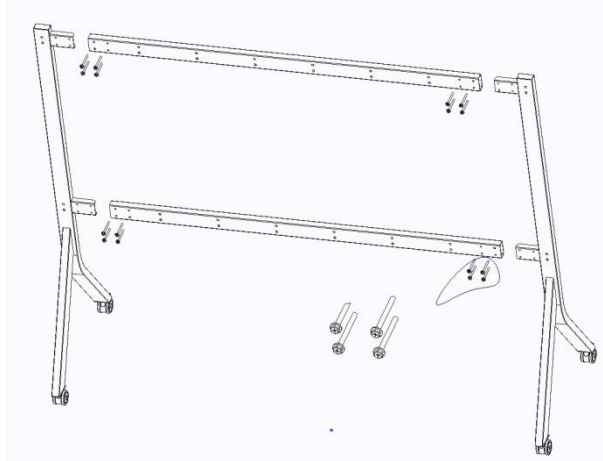

2) Tighten the installation screws with the corresponding tools. The assembled bracket is as shown below:



Step 2: Install the hanging bars

1) Select the corresponding accessories to install the hanging bars, as illustrated below:

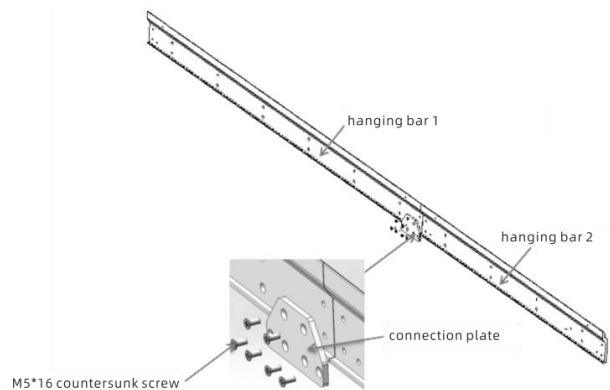

2) Install the hanging bars on the bracket, as illustrated below:

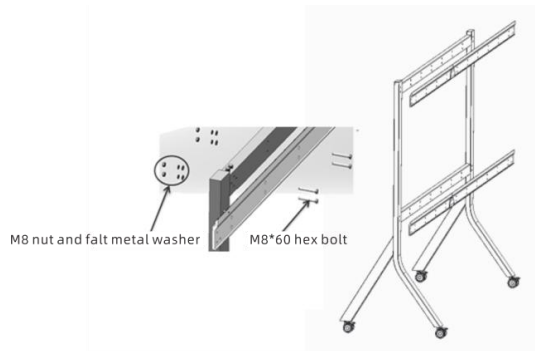

For 138/165-inch

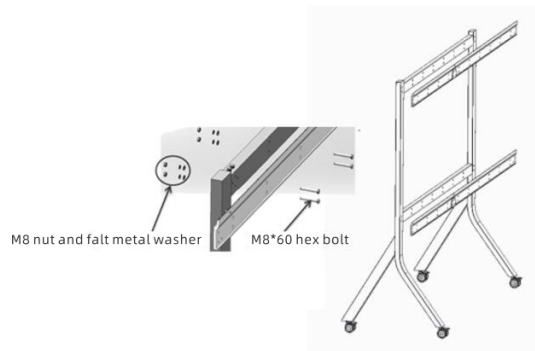

For 120/150-inch

3) The hanging bars and the bracket are assembled, as illustrated below:

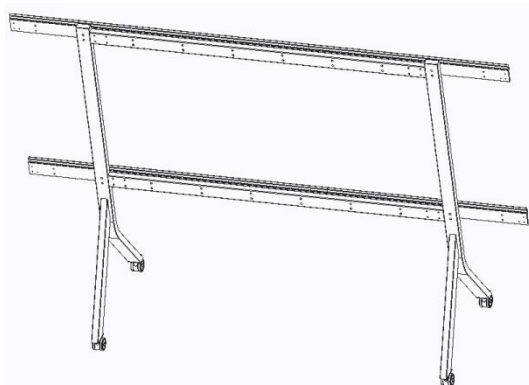

For 138/165-inch

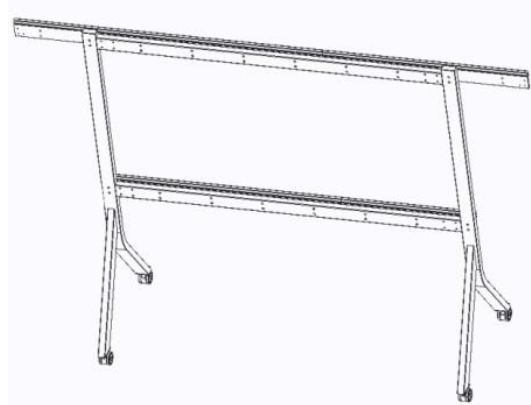

For 120/150-inch

Step 3: Assemble the panels

- 1) The integrated display is delivered with the panels joined into a column according to their numbers. A total of five columns are joined;
- 2) Connect the panels with a tool using hook locks on the top and bottom in the position marked in blue and spring side locks on the sides in the position marked in red, as illustrated below:

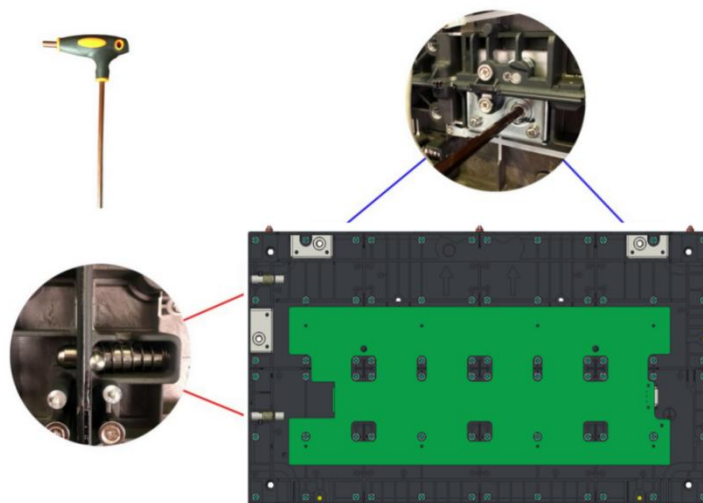

3) Install the hanging plates on the corresponding panel with two M8*25 hex head bolts and flat

spring washers, as illustrated below:

- 4) Remove the locating pins on the top panels and the spring locating pins on the leftmost column viewed from the front. Then secure the upper edging with a cross screwdriver, as illustrated below:

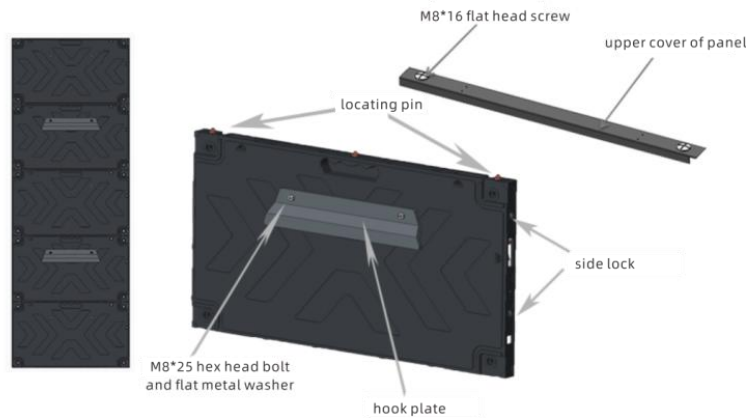

Step 4: Assemble the entire machine

* Make sure that the bracket castors are tightly locked and the hanging bars are level;

- 1) Hang the panel from center to sides. Place the hanging hook of the panel on the hanging bars of the bracket;
- 2) Install the adjacent second column so that the hanging hooks are on the hanging bars and the adjacent side planes are closely attached together. Pull out the side spring locating pin and insert the entire pin into the corresponding locating hole. Then rotate the side hook lock with the corresponding hex wrench until the panels in the left and right columns are fully locked, as illustrated below:

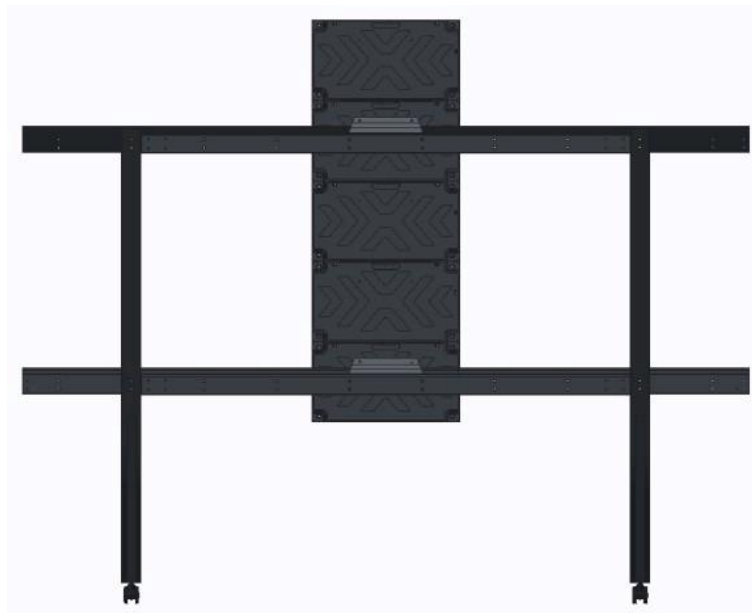

- 3) Install the panels in the rest of the columns, as illustrated below:



For 138/165-inch

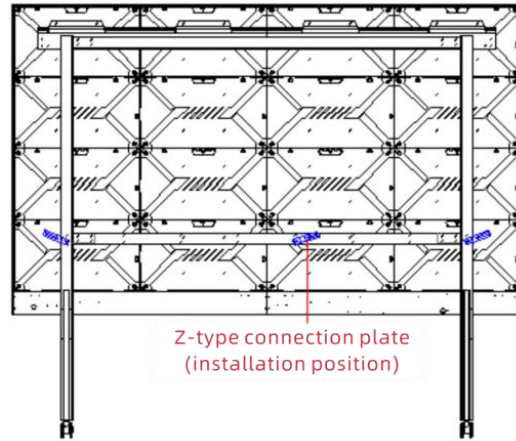

For 120/150-inch

Step 5: Assemble the lower side frame

* The lower side frame assembly is made up of lower frames 1 and 2, connected by a connecting plate;

1) The lower side frame assembly is secured on the lowermost row of panels with rotary hook locks, as illustrated below:

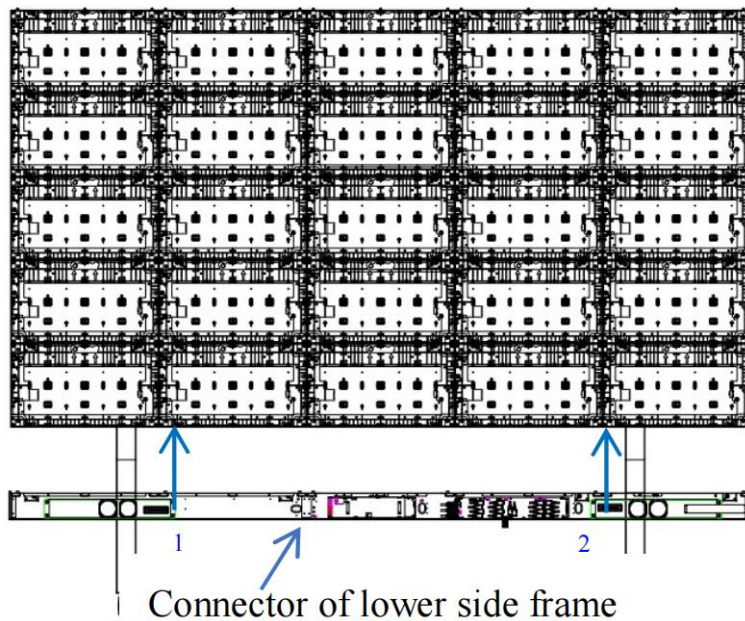

2) Wiring: Red indicates a five-branch power cable and purple indicates a signal cable (network cable). Connect the power and signal cables between the panels according to the diagram. Then connect the signal and power cables to the lower side frame assembly. Insert each column of the signal cables into the corresponding columns of sockets according to their respective positions only. Plug in the power cables with 3p plugin connectors according to their respective positions, as illustrated below.

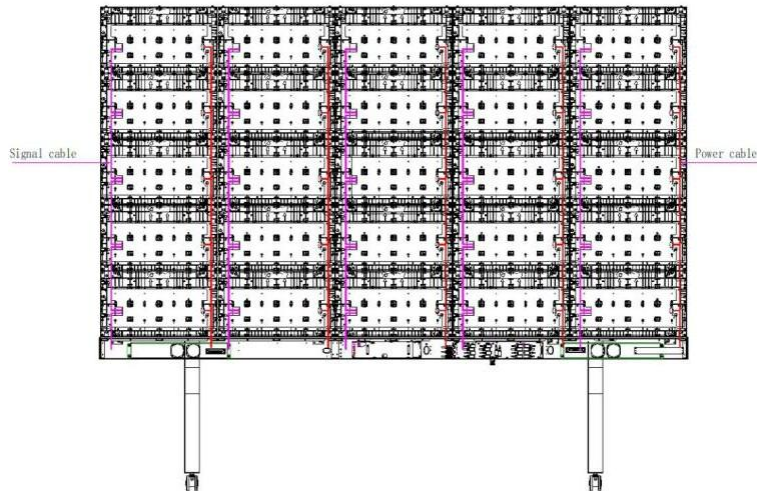

Step 6: Install the modules

* Install the modules from left to right, from right to left, from bottom to top, or from top to bottom as appropriate for the installation environment on the site.

* Repair any improper flatness during assembly.

1) The modules shall be hard connected with hub board and the connectors on the modules. Use the right strength and avoid forceful insertion during installation, as illustrated below:

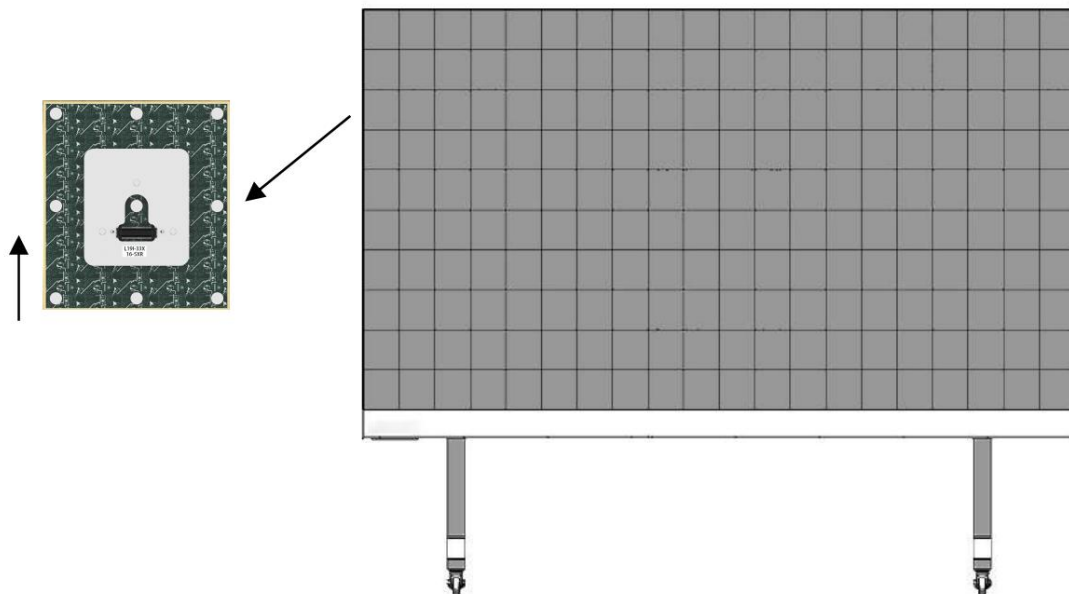

2) Serial numbers of panels and modules. Each of the panels is delivered with a number marked on the upper right (on the inside), which represents the installation position of the panel at the time of factory correction. Each of the modules is also marked with a number (on the back). For example, in the number 16-5, 16 means the lamp board is installed in panel 16 at the time of factory correction; 5 means the position inside panel 15.



3) To achieve better display effect, you can install the modules according to their serial numbers at the time of factory correction as indicated in the diagram.

1-1	1-2	1-3	1-4	01#	6-1	6-2	6-3	6-4	11-1	11-2	11-3	11-4	16-1	16-2	16-3	16-4	21-1	21-2	21-3	21-4	21#
1-5	1-6	1-7	1-8	02#	6-5	6-6	6-7	6-8	11-5	11-6	11-7	11-8	16-5	16-6	16-7	16-8	21-5	21-6	21-7	21-8	21#
2-1	2-2	2-3	2-4	02#	7-1	7-2	7-3	7-4	12-1	12-2	12-3	12-4	17-1	17-2	17-3	17-4	22-1	22-2	22-3	22-4	22#
2-5	2-6	2-7	2-8	03#	7-5	7-6	7-7	7-8	12-5	12-6	12-7	12-8	17-5	17-6	17-7	17-8	22-5	22-6	22-7	22-8	22#
3-1	3-2	3-3	3-4	03#	8-1	8-2	8-3	8-4	13-1	13-2	13-3	13-4	18-1	18-2	18-3	18-4	23-1	23-2	23-3	23-4	23#
3-5	3-6	3-7	3-8	04#	8-5	8-6	8-7	8-8	13-5	13-6	13-7	13-8	18-5	18-6	18-7	18-8	23-5	23-6	23-7	23-8	23#
4-1	4-2	4-3	4-4	04#	9-1	9-2	9-3	9-4	14-1	14-2	14-3	14-4	19-1	19-2	19-3	19-4	24-1	24-2	24-3	24-4	24#
4-5	4-6	4-7	4-8	05#	9-5	9-6	9-7	9-8	14-5	14-6	14-7	14-8	19-5	19-6	19-7	19-8	24-5	24-6	24-7	24-8	24#
5-1	5-2	5-3	5-4	05#	10-1	10-2	10-3	10-4	15-1	15-2	15-3	15-4	20-1	20-2	20-3	20-4	25-1	25-2	25-3	25-4	25#
5-5	5-6	5-7	5-8	06#	10-5	10-6	10-7	10-8	15-5	15-6	15-7	15-8	20-5	20-6	20-7	20-8	25-5	25-6	25-7	25-8	25#

Front View

Step 7: Install the left, right, upper edgings and the lower side frame covers

1) The left and right edgings are clipped in the side spring locating pinhole with clips (as previously described, the spring locating pin on the leftmost of the screen should be removed and an edging should be installed), as illustrated below:

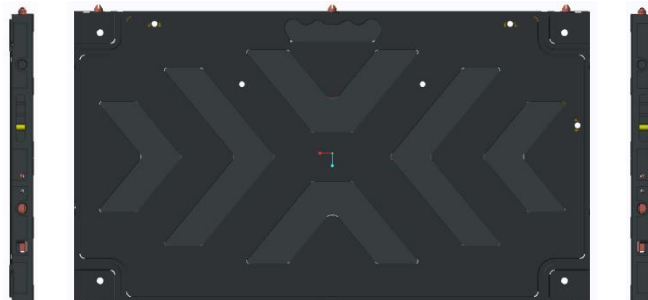

*The letter "R" on the edging means the right edging; "L" means the left edging (as viewed from the front)

2) Install the lower side frame covers from left to right according to their respective positions indicated on the installation diagram and secure them with a cross screwdriver and M3*8 black countersunk head screws. The installed covers are as shown below:



2> Wall mounting*



Wall mounting

*The installation descriptions below are provided for the 138-inch product as an example.

Installation procedure:

Step 1: Install the hanging bars

- 1) Determine the punching positions for the upper and lower hanging bars according to the site environment and the height of the screen above ground. Use a level gauge to ensure levelness;
- 2) The upper and lower hanging bars are each made up of hanging bars 1 and 2 connected by connectors. Connect the connectors with six M6*16 countersunk head screws;

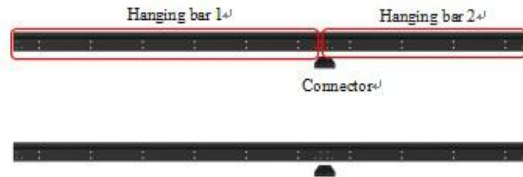

3) The punching positions for hanging bars 1 and 2 are as shown below:

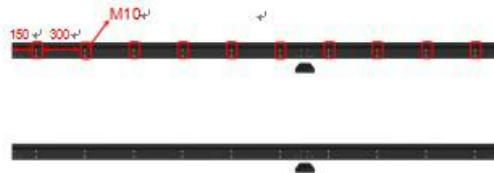

4) Mark the corresponding hole positions. Punch at the marked points with a tool. Each hole is sized 10 mm in diameter;

5) Install at the corresponding hole positions with M8*80 expansion bolts. The expansion bolts are as shown below:



6) Side profile of the installed hanging bars;

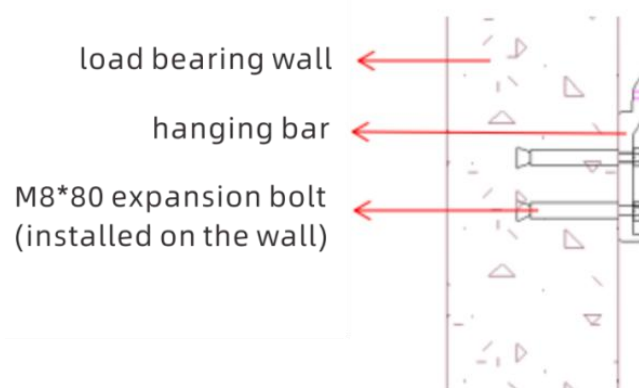

a. The front views of the installed hanging strips are as shown below:

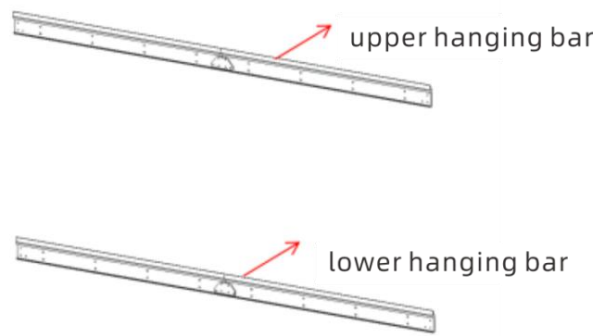

b. Check that the hanging bars are installed properly. You need to confirm: 1) whether it is level; 2) whether the upper and lower hanging bars are properly spaced apart. You may use the following method to check and adjust:

① Use a level gauge to check whether the hanging bars are level and adjust them. Loosen the expansion bolts, push the bars to level with the hand and tighten the bolts again.

② Use a tape measure to check whether the two rows of hanging bars are correctly spaced apart and adjust them. Loosen the expansion bolts, push the bars gently with the hand to fine tune the space and tighten the bolts again.

c. Install the panels by following the installation procedure described for bracket mounting of panels.

III. Functions

(1) Home screen



1. Welcome, a built-in module, used to set the launch theme;
2. ScreenShare, used to enter the wireless screen share operation window;
3. Explorer, used to enter memory management files;
4. More apps, used to enter the more apps screen.

(2) Launch screen

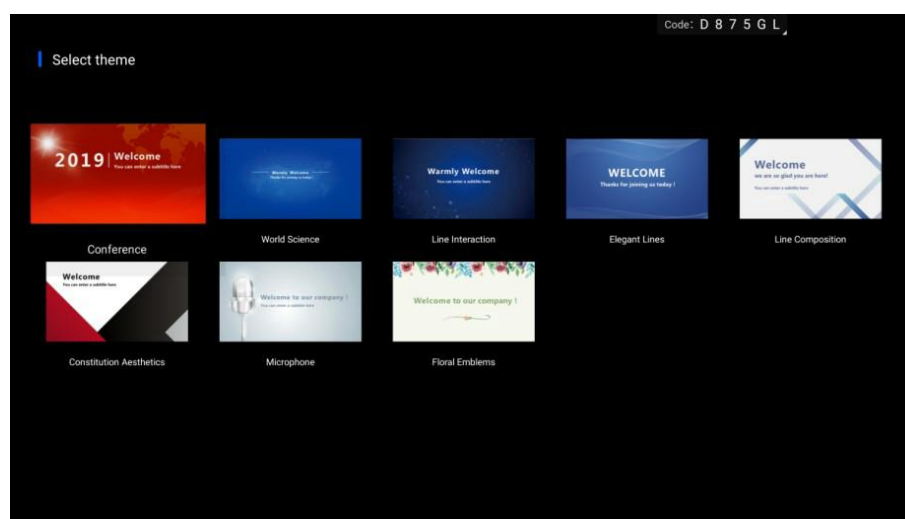

1. A variety of built-in style templates, used to customize pictures and launch addresses or modify the style, color or position of texts, making your launch address more simple and creative;

2. Click“OK” to enter the display page.

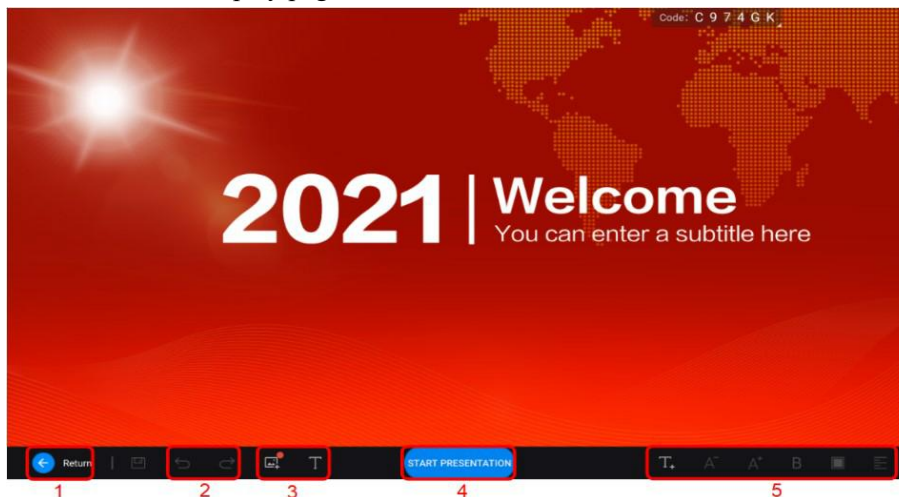

1. Click “Return” to return to the previous page.

2. Cancel/Resume.

3. Edit a picture or file (preferably with the mouse and keyboard).

4. “START PRESENTATION” button, used to start full-screen display. 5. Text tool (preferably operated with the mouse and keyboard)

(3) Wireless screen share

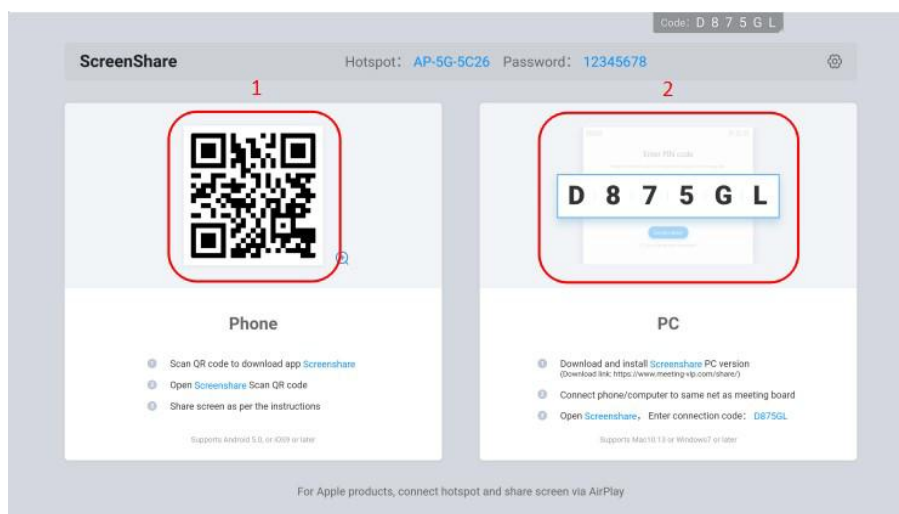

1> Mobile apps

1. Connect to the screen share hotspot;

2. In the case of an Android system user, scan the QR code to download the screen share assistant and use it to share screens; in the case of an Apple client, use Airplay to project screens.

2> Mac Airplay

1. For mobiles or computers with MAC system, find the device hotspot through WIFI and enter your password to connect to the hotspot;

2. Use the Airplay function in the MAC system to transmit screens.

3> Explorer

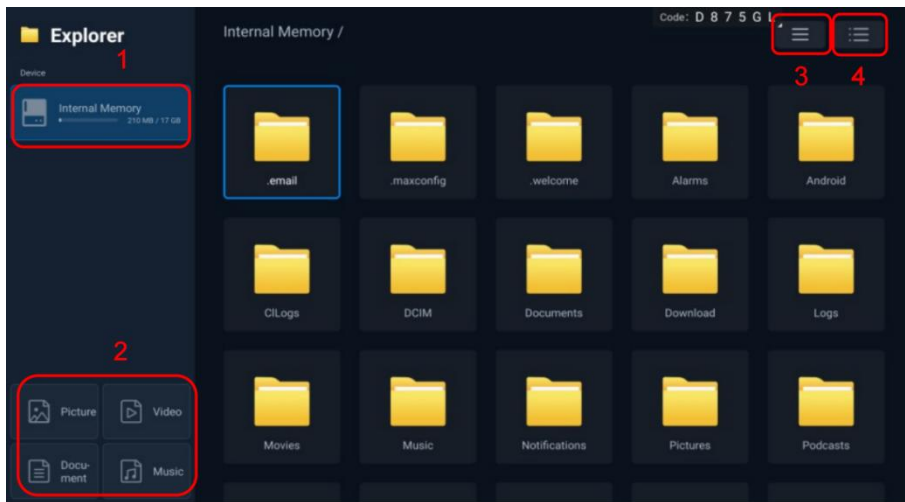

Explorer home page

Explorer: Used to browse or operate files.

1. Display the USB disk(s) mounted
2. Browse files by category (pictures, videos, documents, music)
3. Switch the file display mode
4. Open the menu

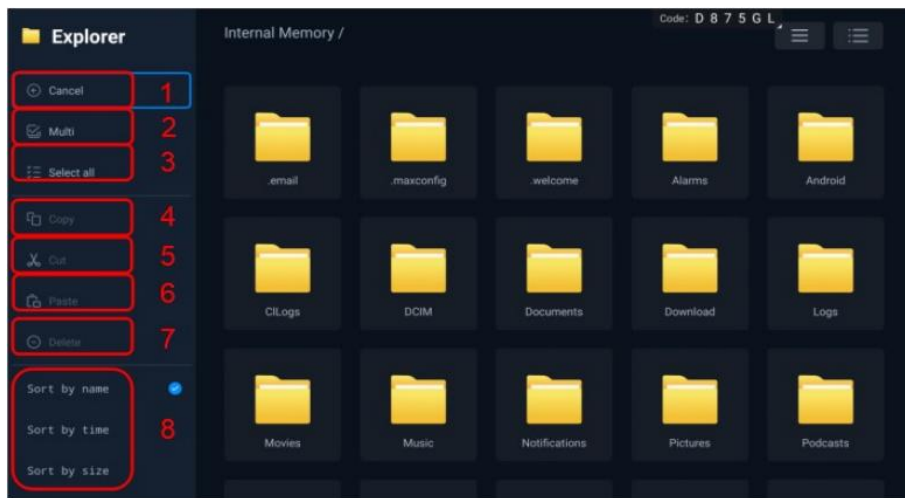

Explorer Menu

1. Cancel: Cancel the operation
 2. Multiple Choice: More than one file can be selected for operation
 3. Select All: Select all files
 4. Copy: Copy the file
 5. Cut: Cut the file
 6. Paste: Paste the file
 7. Delete: Delete the file
 8. Sort: Supports the sorting of files by name, time, or size
- 4> **More Apps**

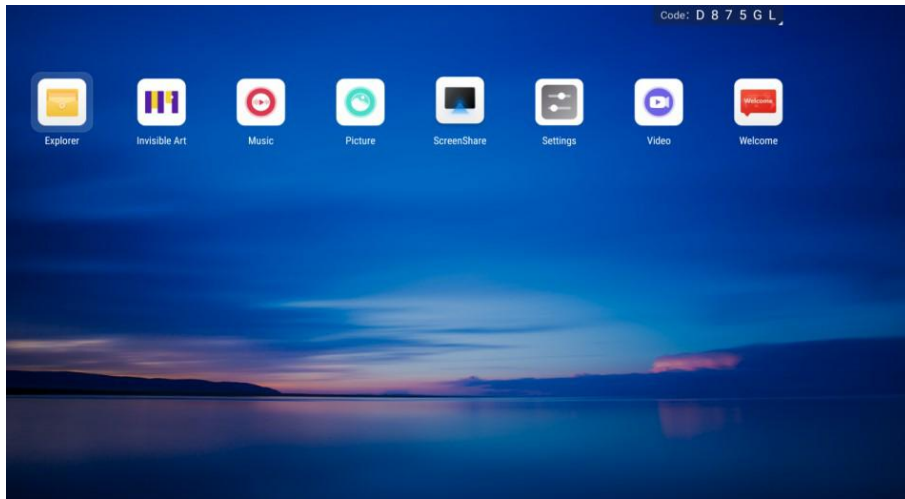

Enter the more apps page to view the software programs currently installed in the machine.

1) Videos

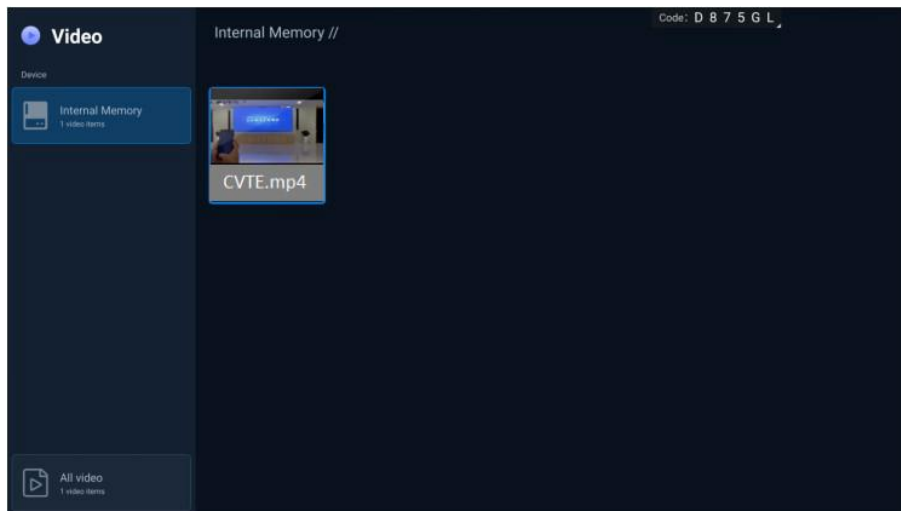

Video file list

1. Click a disk to view all video files therein.
2. Click a video file to play this video file.

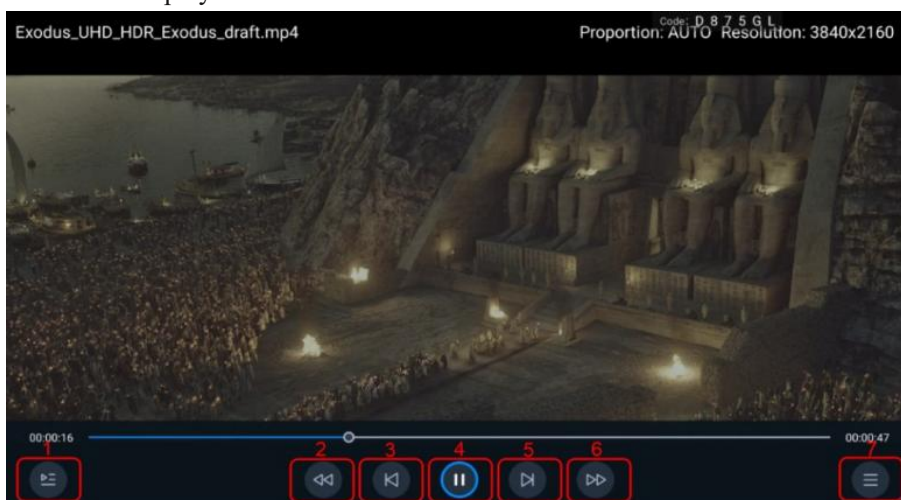

Video play screen

1: Playlist 2: Rewind 3: Previous 4: Play/Pause 5: Next 6: Fast Forward 7: Menu

2) Music

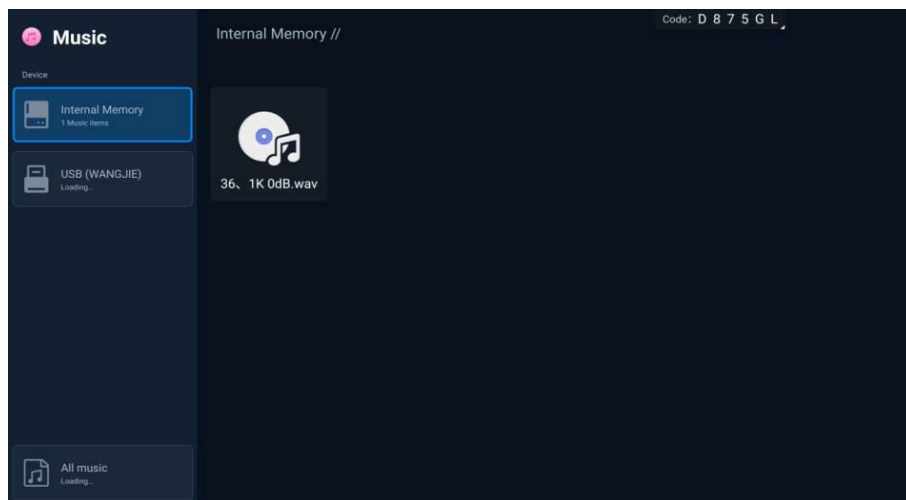

Music file list

1. Click a disk to view all music files therein.
2. Click a music file to play this music file.

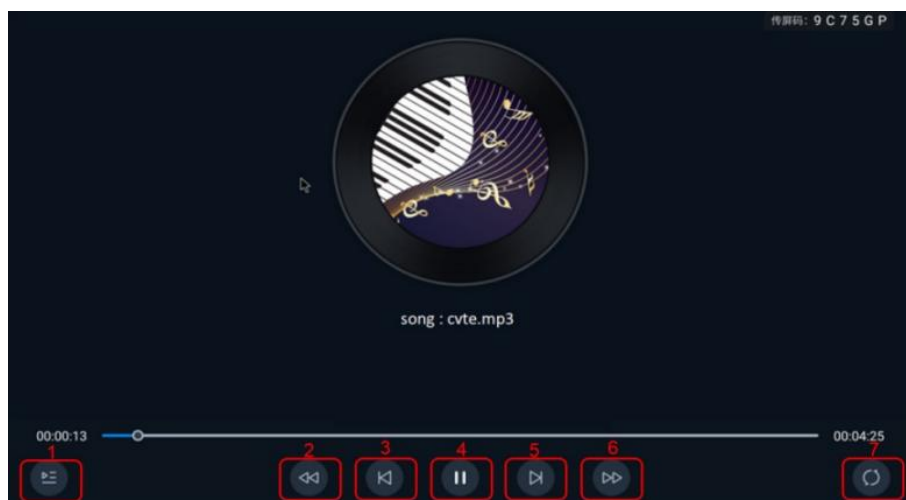

Music play screen

- 1: Playlist 2: Rewind 3: Previous 4: Play/Pause 5: Next 6: Fast forward
- 7: Play mode (single loop / random play / list loop)

3) Gallery

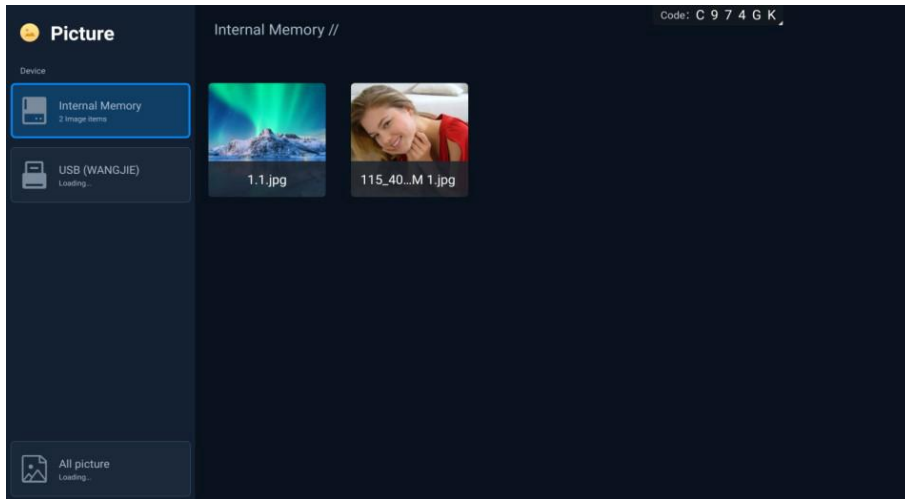

Picture file list

1. Click a disk to view all picture files therein.
2. Click a picture file to view the full-screen display of this picture.

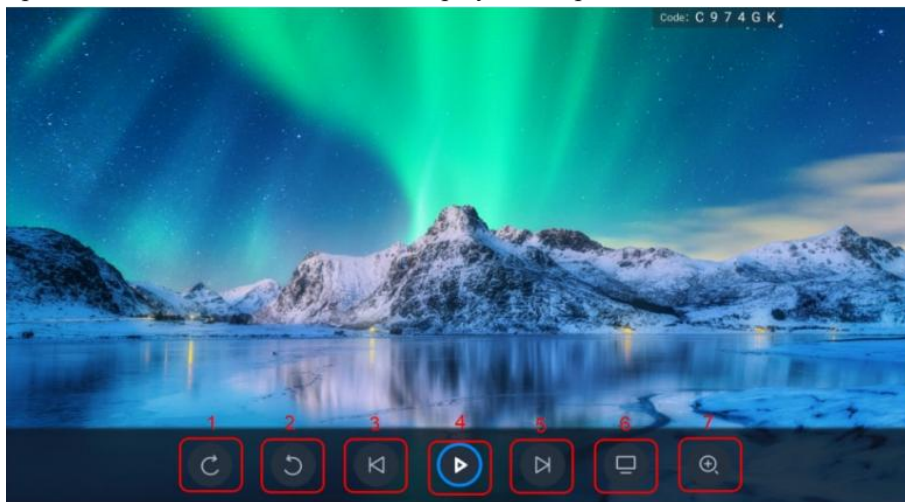

Picture preview

- 1: Clockwise
- 2: Counter clockwise
- 3: Previous
- 4: Play/Pause
- 5: Next
- 6: Set as wallpaper
- 7: Zoom in

IV. Function Menu

Use the option key on the remote control or keypad to call up the menu:

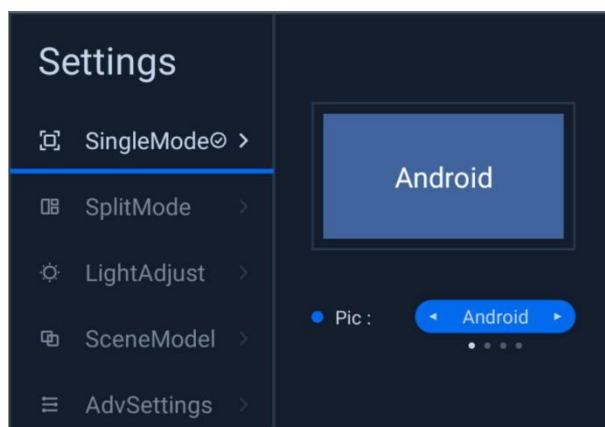

(1) Full screen mode

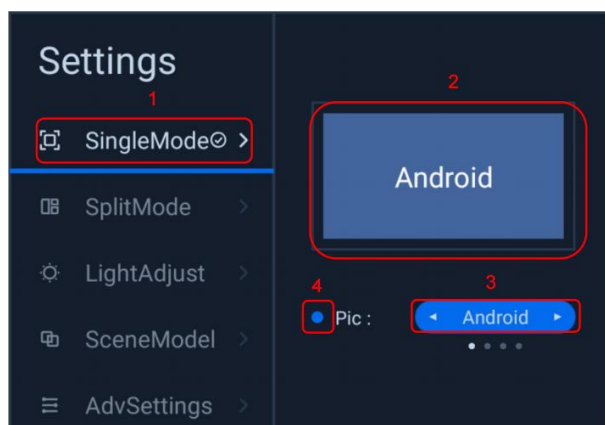

Full screen mode screen

As shown in the “Full Screen Mode Screen”: Full screen mode means the screen is covered by video signals of one single channel so that you can see contents of only one-channel signals.

1. When the “tick” is at “Full Screen Mode”, the current screen is in full screen mode;
2. Indicates the channel of the content currently displayed on the screen;
3. Channel switch button. You may use the “left/right” key on the remote control/front panel to view the channel; click “Enter” to switch to another channel;
4. Channel indicator, which indicates whether the currently viewed channel has signal access; gray means there are no signals while blue means there are signals.

(2) Split screen mode

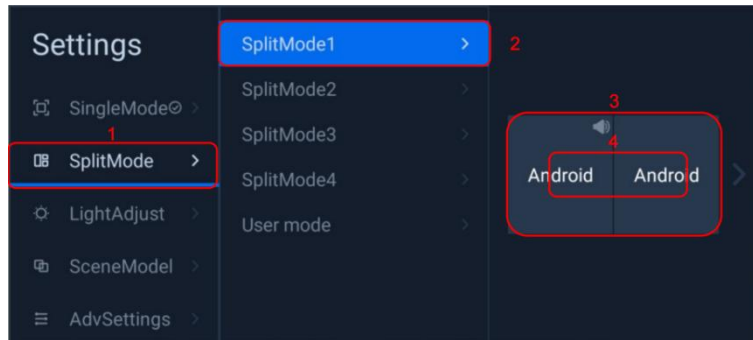

Split screen mode 1

Split screen mode means video signals of more than one channel can be displayed on the screen at the same time.

1. When the “tick” is at “Split Screen Mode”, the current screen is in split screen mode.
2. When the “tick” is at “Split Screen Mode 1”, the current screen is in split screen mode 1.
3. You can view the screen effect achievable by the current split screen mode via the leftmost screen.
4. Channel indicator. You can use the text on the preview to designate the channel name of the screen displayed in the current area. Press “Enter” to switch to the designated mode. Press the “right” key to enter the detailed settings page for split screen mode.

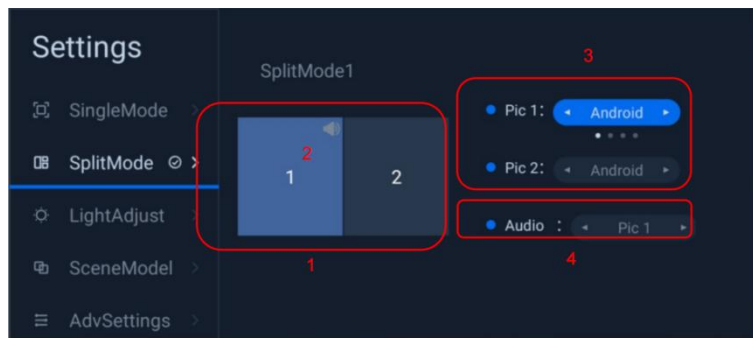

Settings page for split screen mode 1

Split screen mode 1: Video signals of two channels can be displayed on the screen at the same time, on the left and right respectively in equal proportion.

1. You can see the screen area currently being operated via the highlighted area on the preview. In the picture above, screen 1 is being operated.
2. The sound icon indicates from which screen the current sound comes. In the picture, the sound comes from screen 1.
3. With the switch button, you can use the “left/right” key to preview the channel and the “Enter” key to confirm switching the channel of the screen.
4. Sound source selection button. You can use the “left/right” key to preview the sound source screen and the “Enter” key to confirm switching the sound source for outputting the designated screen.

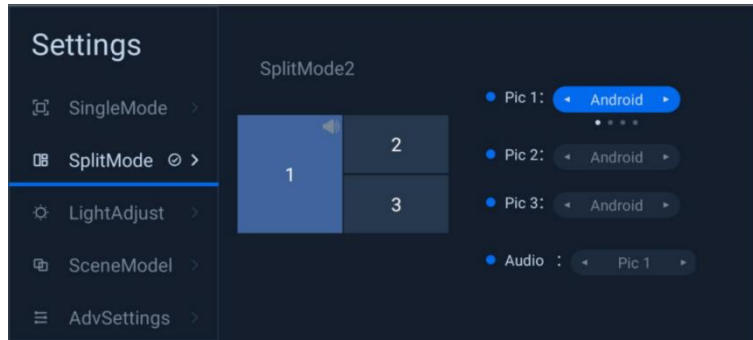

Settings page for split screen mode 2

Split screen mode 2: Video signals of three channels can be displayed on the screen at the same time, with screen 1 occupying a larger display area while screen 2 and screen 3 equally occupying a smaller area each.

The contents operation and display are the same as those for split screen mode 1.

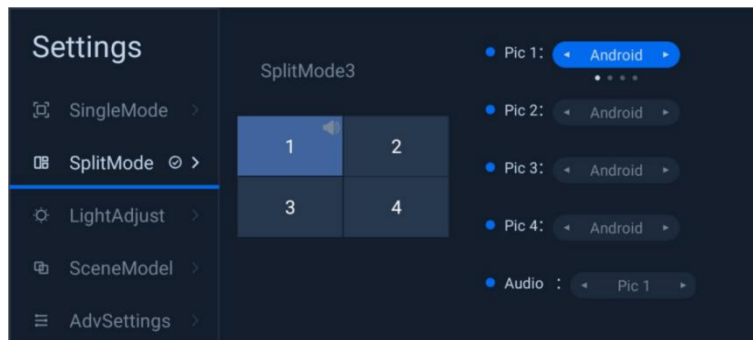

Settings page for split screen mode 3

Split screen mode 3: Video signals of four channels can be displayed on the screen at the same time, with all four screens equally displayed on the screen. The contents operation and display are the same as those for split screen mode 1.

(3) Brightness adjustment

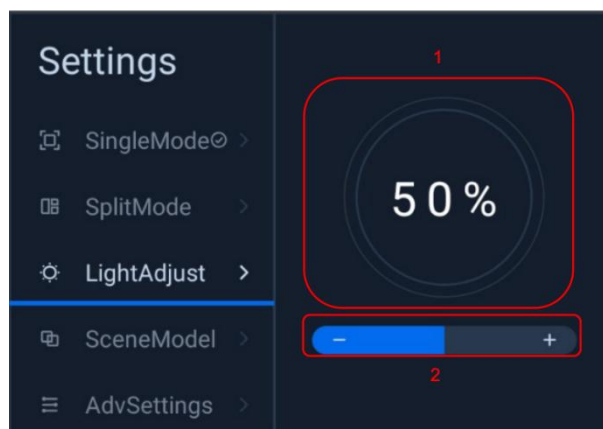

1. The figure in the circle represents the current brightness.

2. The focus is in the brightness adjustment box. Use the “left/right” key to adjust the brightness.

(4) Profiles

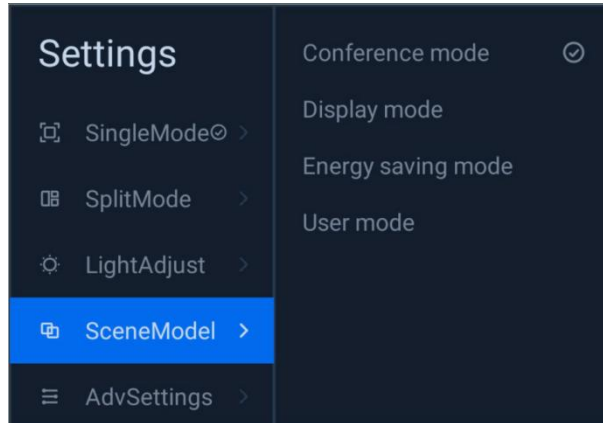

Profiles: You can switch between different use scenes.

1. “Tick” means the current profile, currently available for conference mode, demo mode, energy saving mode, and user mode; after designating a mode, press “Enter” to switch to the designated mode.

(5) Advanced settings

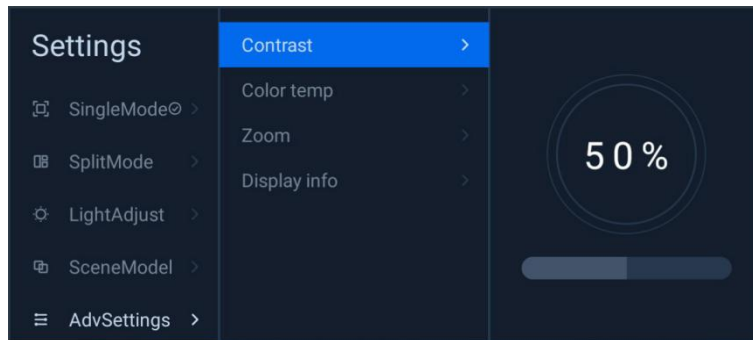

1. Contrast: Used to adjust the contrast.
2. Color temperature: Used to adjust the color temperature mode (standard, cold, warm).
3. Display scale: Used to adjust the display scale on the screen (available only for full screen mode).
4. Display information: Used to display the resolution of the current video signal.

V. Settings Menu

Click “Settings” to enter the settings menu page

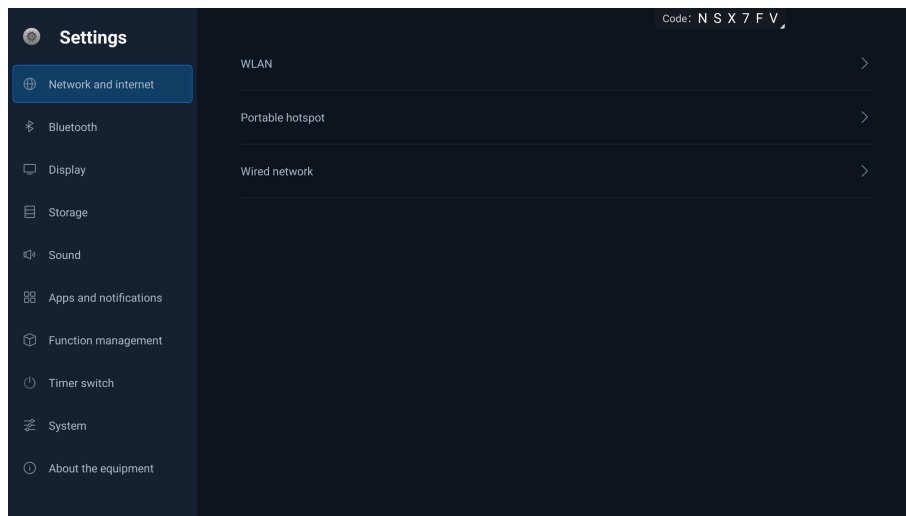

(1) Network and Internet

1> WLAN

Open WLAN to search the service network automatically. Click the network to connect to it.

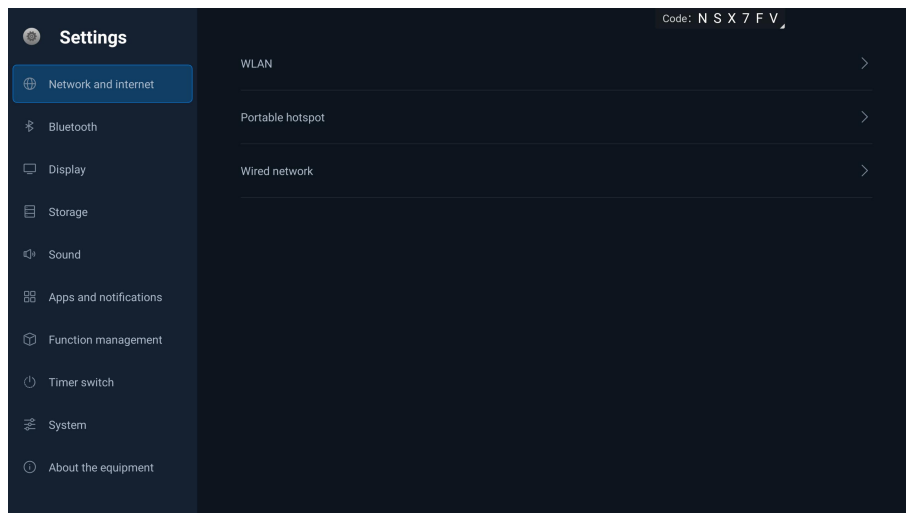

2> Hotspots

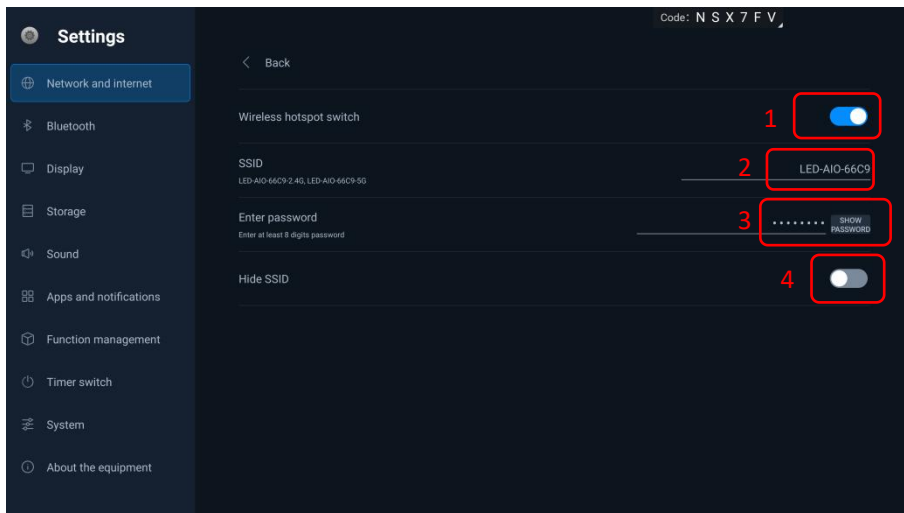

Portable Hotspots

Portable hotspots: Both 2.4G and 5G hotspots can be produced. “-2.4G”or“-5G” will be automatically suffixed to the current hotspot to distinguish between 2.4G and 5G hotspots. (In the picture, the hotspot name of the “portable hotspot” is displayed as LED-AIO-6673.

The actual hotspot name will be LED-AIO-6673-5G in the case of a 5G hotspot or LED-AIO-6673-2.4G in the case of a 2.4G hotspot.)

1. Hotspot switch: Open or close a hotspot
2. Hotspot name: Modify the hotspot name
3. Hotspot password: Modify the hotspot password
4. Hide hotspot: Show or hide a hotspot. After a hotspot is hidden, other devices will not be able to search it although it is actually on.
5. Apply: Click “Apply” to restart any hotspot whose information has been modified and apply the modification.

6. Cancel: Restore the modified content.

3> Wired network

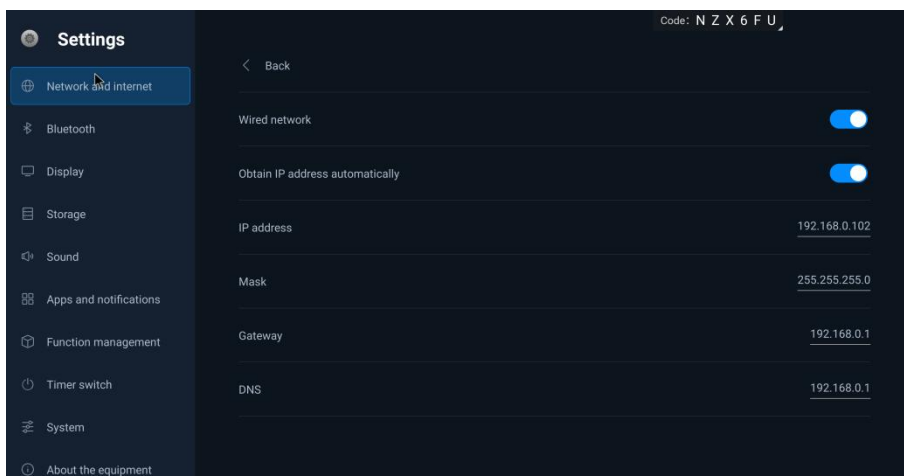

Wired network

(2) Bluetooth

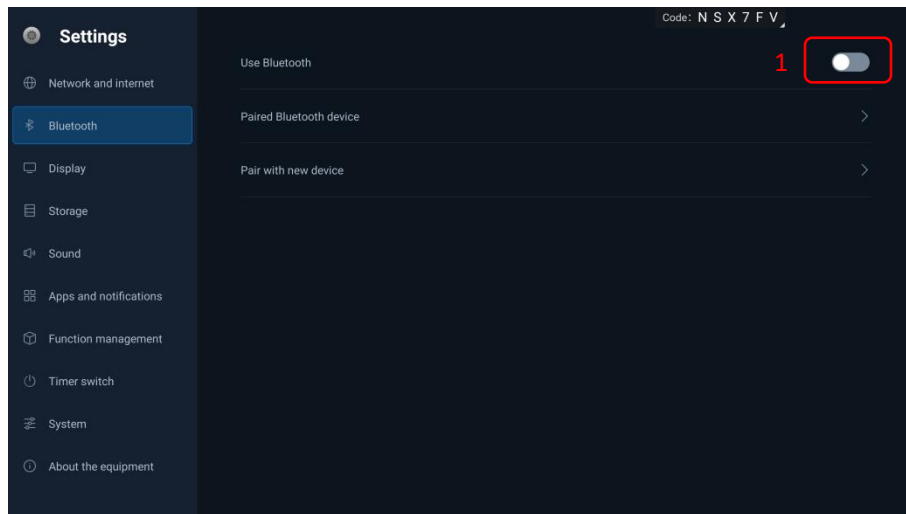

1. Bluetooth switch: Bluetooth can be turned on or off;

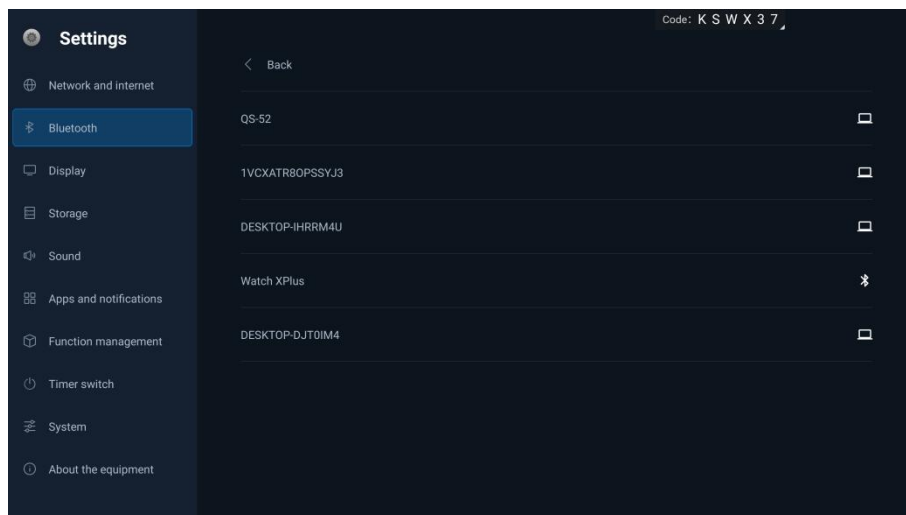

2. After Bluetooth is turned on, you can connect to Bluetooth devices within the search range;

(3) Display

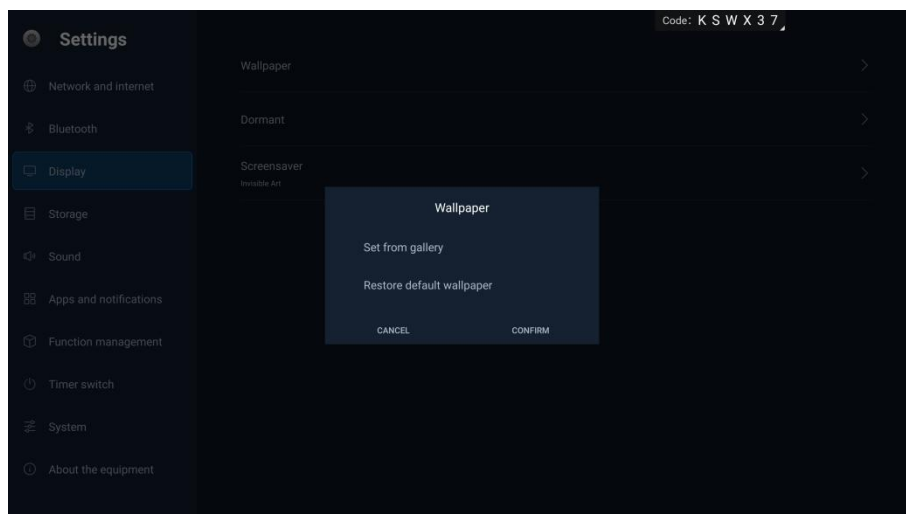

Wallpaper

Used to set the wallpaper of your integrated display. You can set a wallpaper via the gallery or restore the factory default wallpaper.

(4) Storage

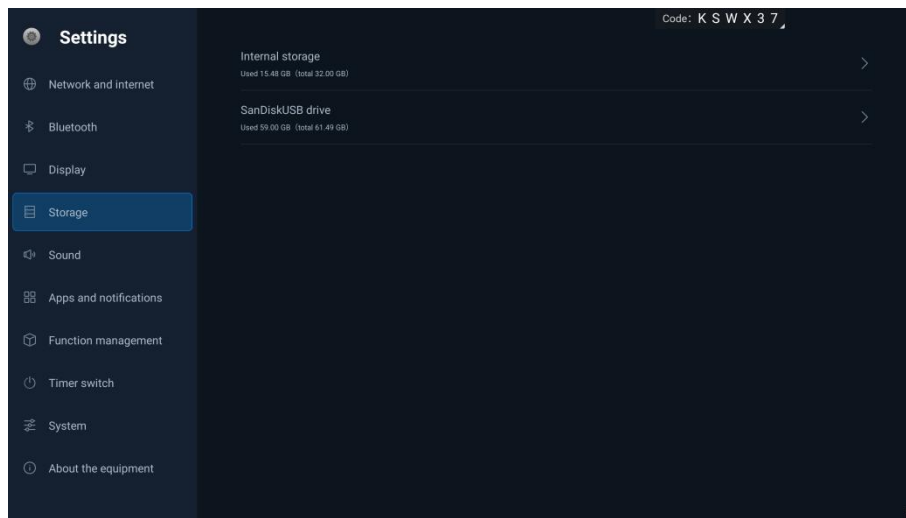

Storage

Used to display the storage conditions of a storage disk mounted.

(5) Sound

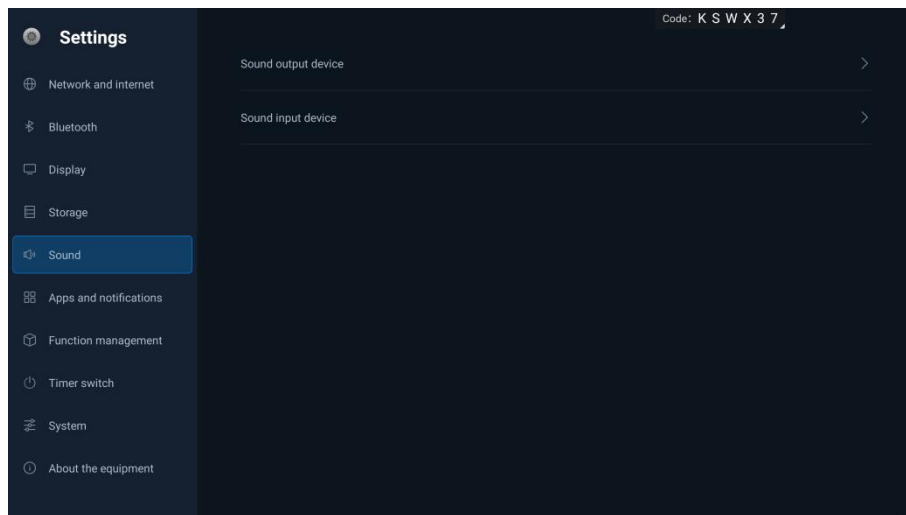

Sounds

1> Sound output device

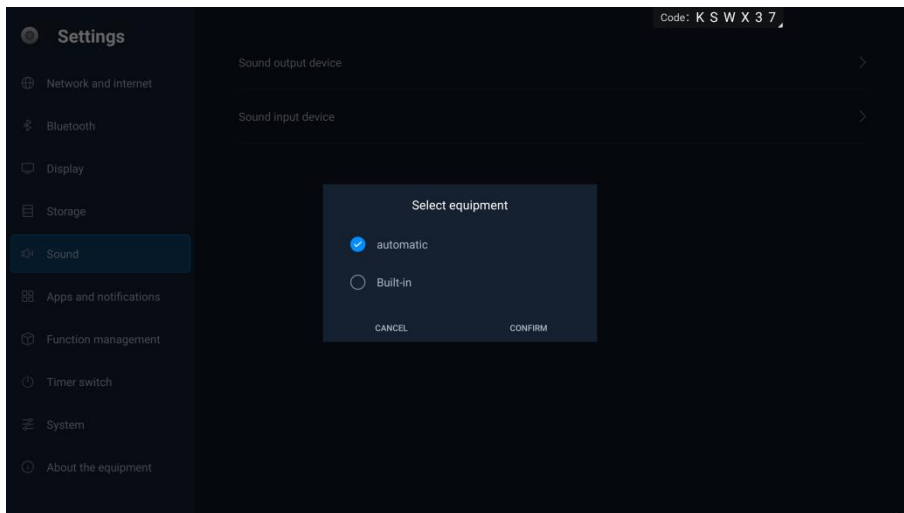

Sound output device

All video devices mounted will be automatically scanned. You can select a device to designate from which device the sound will be outputted.

1. Auto: The system will automatically select a device to output the sound.
2. Built-in: The built-in loudspeaker will output the sound.

2> Microphone device

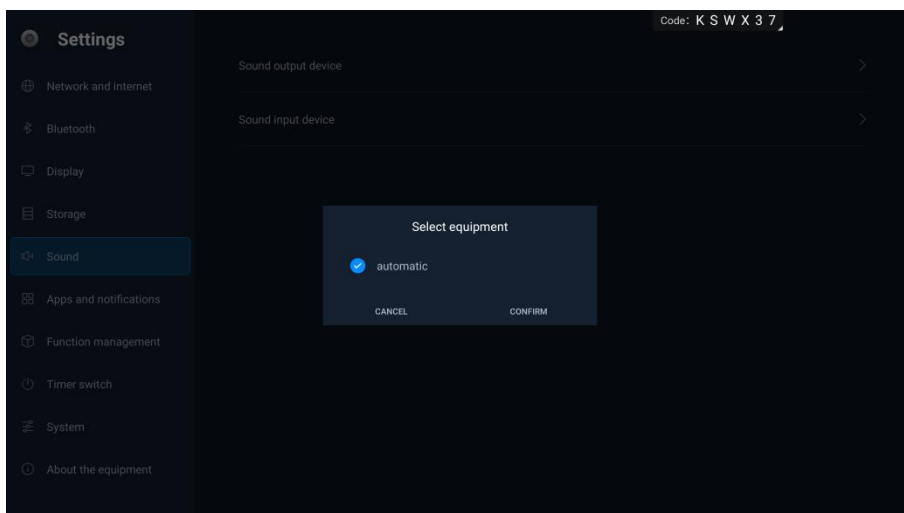

Microphone device

Auto: The system will automatically select a microphone device. All microphone devices mounted will be automatically scanned. Select a device to designate which microphone will be used for pickup.

(6) APP notification

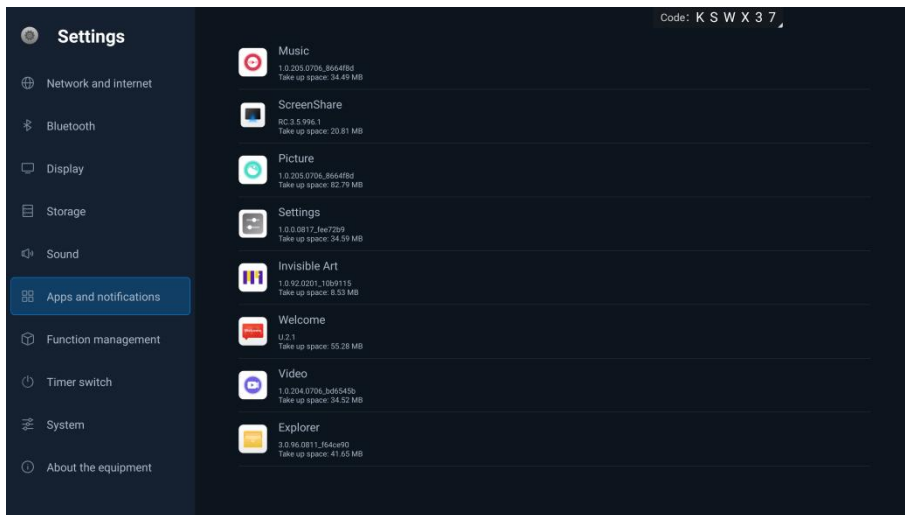

App notification: Used to display the software apps currently installed in the system. Click an app to download or disable it. Default software apps in this system do not support unloading.

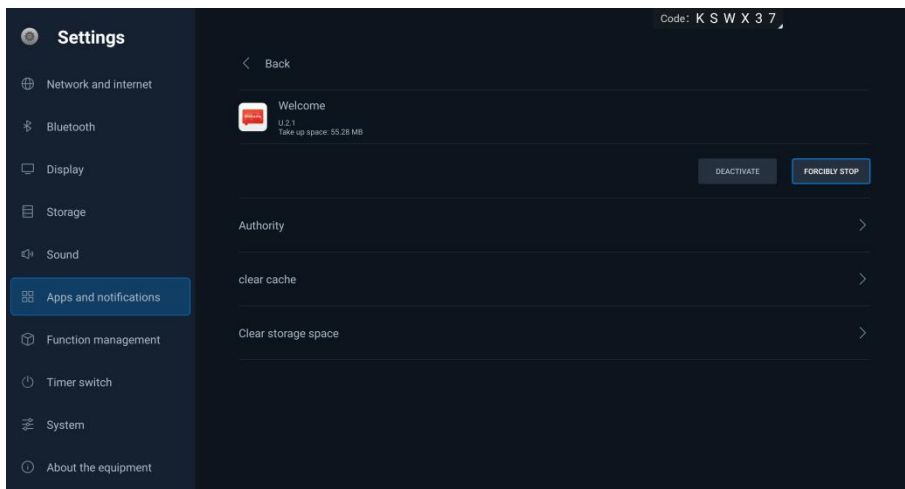

System default apps

(7) Function management

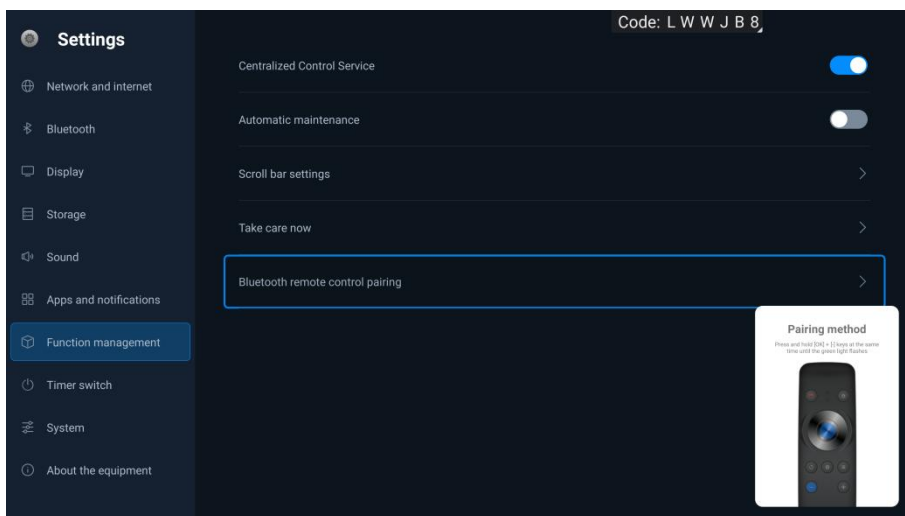

Function management

Central control service: Used to open/close central control service. You can control the integrated display remotely only when central control service is on.

Auto Maintenance: the maintenance will be performed at the boot up of device according to the power off time.

Bluetooth remote control

pairing:Press " OK" and“-”at the same time till the green light blinking, enter to bluetooth paring mode to pair automatically, will show " success repairing" after done .

(8) System

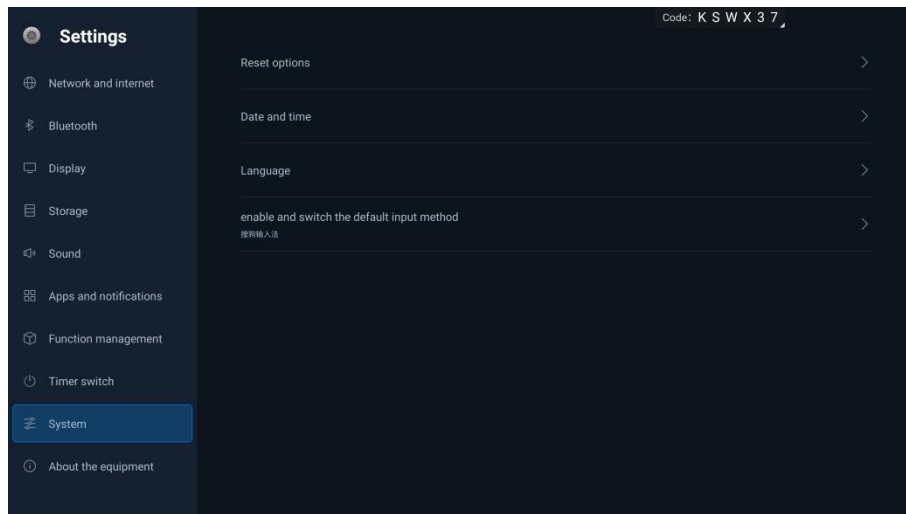

1. Reset options: Networks,apps or device can be reset . 2. Date&time:Used to reset the date and time.

3. Languages &input:Used to set the languages.

(9) About the Device

Used to display information related to the device.

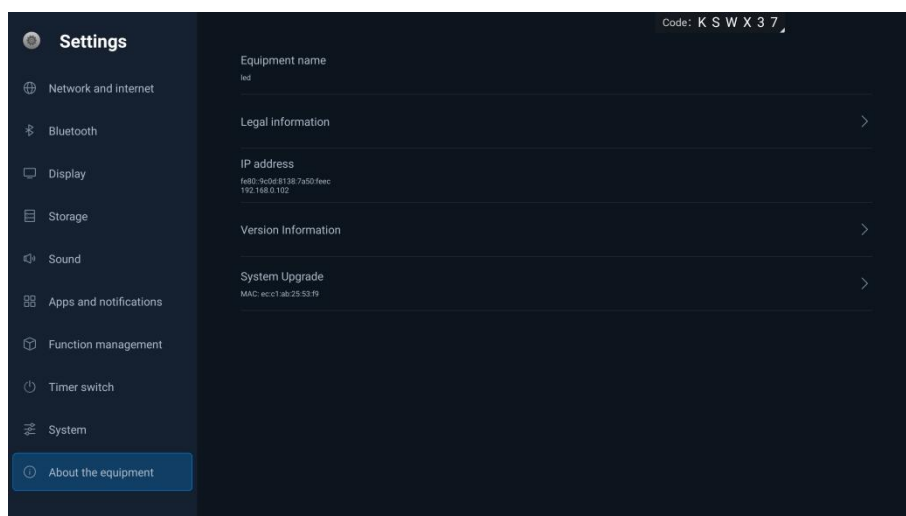

VI. Simple Troubleshooting

(1) Part of the screen doesn't light up after power on

1>Check whether the network cable in the panel is in poor contact 2>Check whether the power cable in the panel is in poor contact.

(2) The wireless dongle doesn't work

1>Check whether the wireless dongle is tightly inserted;

2>Check whether the wireless dongle is paired. To pair the wireless screen projector, you need to insert it into the USB port of the machine and wait for a prompt saying that the dongle is successfully paired;

3>Check whether a driver software has been installed in your computer. If the projector cannot be automatically installed after it is inserted into the USB port of your computer, you need to enter "My Computer" manually, find the drive letter of the transmitter in the device driver and click "Install".

(3) The indicator doesn't work

1>Check whether the power supply is functional; 2>Check whether the switch of the machine is turned on.



(4) No image display after connecting to computer with a HDMI cable

1>Check whether you are currently in a HDMI channel;

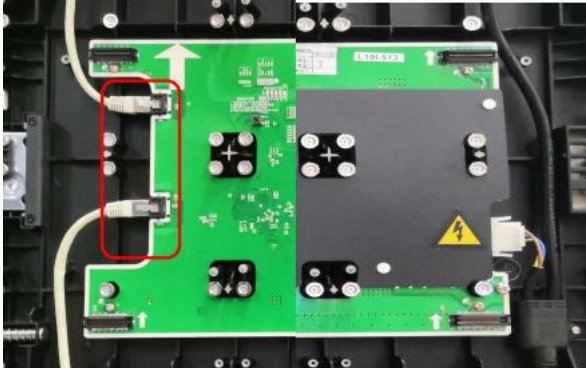
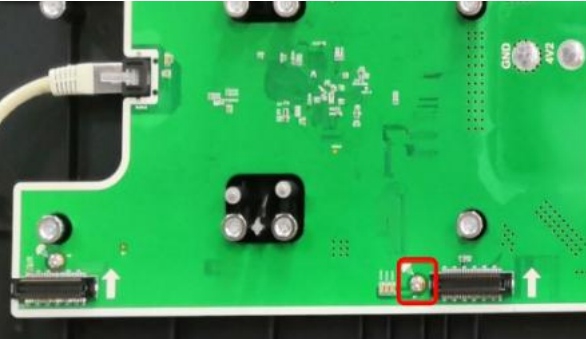

2>Check whether the HDMI cable between the machine and the external computer has come off or is in poor contact.

VII. Parts Replacement

(1) Replacing the 3-in-1 board

Procedure	Illustration	Mrthod
Step 1		Locate the faulted panel and remove all module
Step 2		Disconnect the power supply and network
Step 3		Remove the 8 screws on the 3-in-1 board
Step 4		Remove the faulted 3-in-1 board and replace it with a new one

(2) Replacing the module

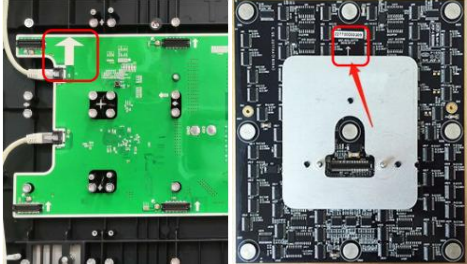
Procedure	Illustration	Mrthod
Step 1		<p>Locate the faulted module and attach the side bevel of the pre-maintenance tool right below the module</p>
Step 2		<p>Rotate the pre-maintenance tool upward slowly from the curved plane to the bottom plane; take out the module in the parallel direction after gripping the module</p>
Step 3		<p>Hold the module with your full hand and rotate the maintenance tool off the module</p>
Step 4		<p>Install the module in the same direction as indicated by the arrow</p>

VIII. Special Statements

IPR Declaration: All hardware designs and software programs related to this product are protected by copyright laws. No part of this product or this operation manual may be reproduced unless with our prior authorization.

All texts and pictures contained herein are provided for information only. None of them shall be construed as any commitment in any form.

The appearance design of this product is subject to further improvement or modification without notice.

Note: HDMI, HDMI HIGH-DEFINITION MULTIMEDIA INTERFACE, and the HDMI logo are trademarks or registered trademarks of HDMI Licensing LLC in the United States and other countries.