



# Klick&Show

**Schnellstartanleitung** | Quick start guide | Guide de démarrage rapide | Guida Rapida | Snabb Start | Guía de inicio rápido | Hızlı Kurulum Rehberi | Prvo uputstvo

**K-42UC Kit**     SKU 7488 000 330  
**K-42H Kit**     SKU 7488 000 312  
**K-40 Base Unit**     SKU 7488 000 315



**Firmware aktualisieren / Update firmware / Mettre à jour le firmware / Aggiornamento del firmware / Uppdatera firmware / Actualizar firmware / Ürün yazılımını güncelleme / Firmware frissítése**



Bitte überprüfen Sie den aktuellen Stand der Firmware / Please check the current status of the firmware / Veuillez contrôler la version actuelle du firmware / Controllare lo stato attuale del firmware / Kontrollera den aktuella statusen för firmware / Compruebe el estado actual del firmware / Lütfen aygıt yazılımının mevcut durumunu kontrol edin / Kérjük, ellenőrizze a firmware aktuális állapotát



[www.klickandshow.com](http://www.klickandshow.com)

**Ausführliches Benutzerhandbuch / Detailed user manual / Manuel d'utilisation / Manuale d'uso / Användarhandbok Manual del usuario / Kullanma kılavuzu/ Korisnički vodič**



Ein vollständiges Benutzerhandbuch finden Sie auf unserer Webseite / You will find a complete user manual on our website / Vous trouverez un manuel d'utilisation complet sur notre site web / Il manuale d'uso completo è disponibile sul nostro sito web / Du hittar en komplett bruksanvisning på vår webbplats / Encontrará un manual de usuario completo en nuestro sitio web / Web sitemizde eksiksiz bir kullanım kılavuzu bulacaksınız / A teljes felhasználói kézikönyv megtalálható a weboldalunkon

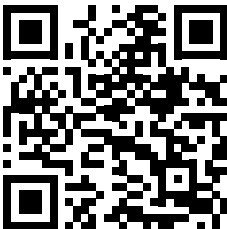

[help.klickandshow.com](http://help.klickandshow.com)

## Bestimmungsgemäße Verwendung

Klick&Show ist ein Drahtlos-Präsentationssystem zur Verarbeitung audiovisueller Inhalte verschiedenster IT-Geräte und Plattformen.

### Sicherheitshinweise

- Bitte die Anleitung sorgfältig durchlesen und aufbewahren
  - Das Kindermann Klick&Show Basis-Gerät darf nur mit Sicherheitskleinspannung über das zugehörige Netzteil betrieben werden
  - Das Gerät darf nur in trockenen, geschlossenen Räumen gelagert und eingesetzt werden, ohne mechanische Belastungen
  - Stellen Sie das Gerät an einem Ort mit ausreichender Belüftung auf
  - Zum Reinigen keine Flüssigkeiten oder Verdüner verwenden (Stromversorgung vorher entfernen!)
  - Entfernen Sie die Stromversorgung bei längerem Nichtgebrauch
  - Die Verwendung nicht geeigneter Zubehöerteile kann zur Beschädigung oder Fehlfunktion führen
- 

## Intended use

Klick&Show is a wireless presentation system for processing audio-visual content from different devices.

### Safety instructions

- Please read the instructions carefully and store them
  - The Kindermann Klick&Show base unit can only be operated with a safety low voltage via the associated power supply unit
  - The device must only be stored and used in a dry, closed environment without mechanical stress
  - Install the unit in a place with adequate ventilation
  - Do not use any liquids or thinners for cleaning (remove the power supply beforehand!)
  - Remove the power supply for long periods of non-use
  - The use of unsuitable accessories may result in damage or malfunction
  - Please observe the safety instructions of the devices to be connected
- 

## Utilisation conforme

Klick&Show est un système de présentation sans fil pour le traitement de contenus audio-visuels d'appareils les plus diversifiés.

### Consignes de sécurité

- Prière de lire et de conserver soigneusement le manuel
  - L'appareil de base Klick&Show de Kindermann peut uniquement être exploité avec une tension basse de sécurité, à l'aide de l'alimentation électrique correspondante
  - L'appareil peut uniquement être stocké et employé dans des pièces sèches et fermées, sans contraintes mécaniques
  - Installer l'appareil dans un lieu, disposant d'une ventilation suffisante
  - Pour le nettoyage, ne pas utiliser de liquides ou de diluants (Auparavant, retirer l'alimentation en courant!)
  - Lors d'un non-usage prolongé, retirer l'alimentation en courant
  - L'utilisation d'accessoires non appropriés peut provoquer des dommages ou des dysfonctionnements
- 

## Uso previsto

Klick&Show è un sistema di presentazione wireless per elaborare contenuti audio-video da apparecchi differenti.

### Norme di sicurezza

- Si prega di leggere con attenzione le istruzioni e di conservarle
- Kindermann Klick&Show può essere alimentato in sicurezza solamente dall'alimentatore a basso voltaggio incluso nella confezione
- Il dispositivo deve essere conservato ed usato solamente in ambienti interni asciutti e in assenza di possibili stress meccanici
- Installare l'unità solamente in luoghi che permettano un'adeguata ventilazione
- Non usare prodotti liquidi odolenti per la pulizia (per la pulizia, rimuovere prima l'alimentazione!)
- Rimuovere l'alimentazione in caso di prolungati periodi di inutilizzo
- L'uso di accessori non originali potrebbe causare danni e malfunzionamenti

## Voorgenomen gebruik

De Klick&Show K-10S is een draadloos presentatie systeem voor het verwerken van audiovisuele content van verschillende toestels.

### Veiligheidsinstructies

- Lees de instructies voor gebruik nauwkeurig door en bewaar deze
- De Kindermann Klick&Show mag alleen worden gebruikt met de meegeleverde universele voeding
- De Kindermann Klick&Show mag alleen gebruikt en bewaard worden in een droge afgesloten ruimtezonder mechanische spanning
- Installeer het apparaat alleen in een voldoende geventileerde omgeving
- Gebruik geen vloeistoffen of thinner om het apparaat te reinigen (koppel de voeding los voor het reinigen)
- Koppel de voeding los als het apparaat voor een langere periode niet gebruikt zal worden
- Het gebruik van niet geschikte accessoires kan resulteren in schade of slecht functioneren

## Uso previsto

Klick&Show es un sistema de presentación inalámbrico para el procesamiento de contenidos audiovisuales de varias equipos.

### Instrucciones de seguridad

- Lea las instrucciones cuidadosamente y consérvelas
- El aparato básico Kindermann Klick&Show sólo puede funcionar con tensión baja de seguridad a través de la fuente de alimentación correspondiente.
- El dispositivo solo se puede almacenar y usar en espacios secos y cerrados sin tensión mecánica
- Instale el dispositivo en un lugar con ventilación adecuada
- No use líquidos o diluyentes para la limpieza (ísepare antes la fuente de alimentación!)
- Retire la fuente de alimentación cuando no lo utilice durante mucho tiempo
- El uso de accesorios inadecuados puede provocar daños o un mal funcionamiento

## Kurulum amaci

Klick&Show, çeşitli cihazlarda görsel-işitsel içeriği işlemek için kablosuz bir sunum sistemidir.

### Güvenlik talimatları

- Lütfen talimatları dikkatlice okuyun ve saklayın
- Kindermann Klick&Show sadece ilgili güç kaynağı ünitesi üzerinden emniyetli düşük voltajla çalıştırılabilir
- Cihaz sadece kuru ve kapalı bir ortamda saklanmalı ve kullanılmalıdır
- Üniteyi yeterli havalandırmaya sahip bir yere kurun
- Temizlik için herhangi bir sıvı veya tiner kullanmayın (güç kaynağını öncesinde çıkarın!)
- Uzun süre kullanılmayacaksa güç kaynağından çıkarmış olduğunuza emin olun
- Uygun olmayan aksesuarların kullanılması hasara veya arızaya neden olabilir

## Namjeravanu upotrebu

Klick&Show je bežični prezentacijski sustav za obradu audiovizualnog sadržaja iz širokog spektra uređaja.

### Sigurnosne upute

- Pažljivo pročitajte upute i zadržati ih
- Kindermann Klick&Show osnovnom jedinicom može se upravljati samo sigurnosnim niskim naponom preko pripadajuće jedinice punjačem
- Uređaj se mora čuvati i koristiti samo u suhom i zatvorenom okruženju bez mehaničkih naprezanja
- Postavite jedinicu na mesto sa odgovarajućom ventilacijom
- Ne koristite tečnost ili razrjeđivače za čišćenje (prethodno uklonite ispravljač!)
- Izvadite dovod ispravljač za dugotrajno nekorišćenje
- Uпотреba neprikladnog pribora može dovesti do oštećenja ili neispravnosti
- Obratite pažnju na sigurnosna uputstva za uređaje koje treba spojiti

Lieferumfang / Scope of delivery / Contenu de livraison / Contenuto della confezione /  
Paket innehåll / Alcance de la entrega / Kutu içeriği / Sadržaj paketa

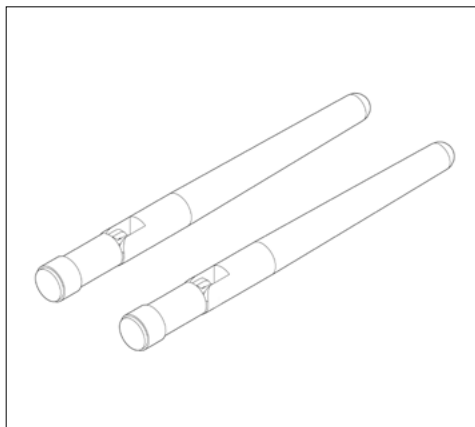
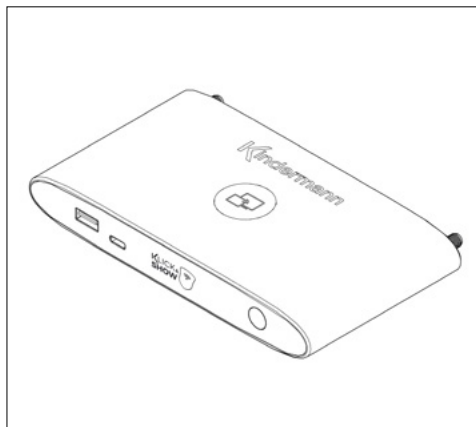

- > 2x HDMI: 7488 000 330
- > 2x USB-C: 7488 000 312

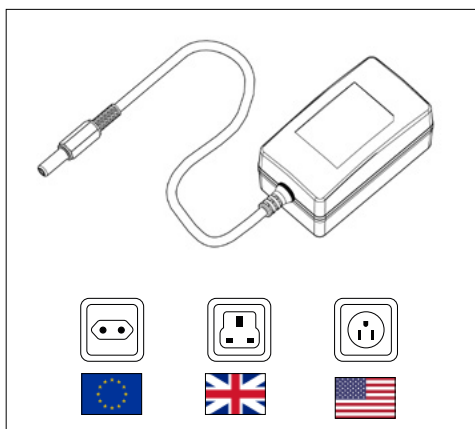
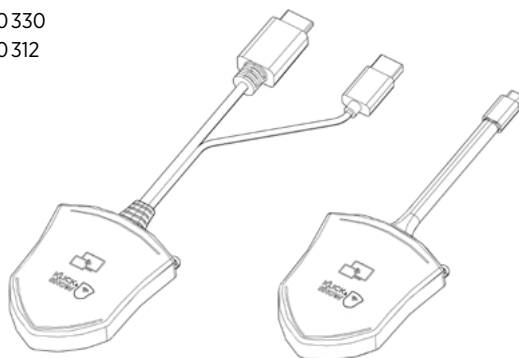

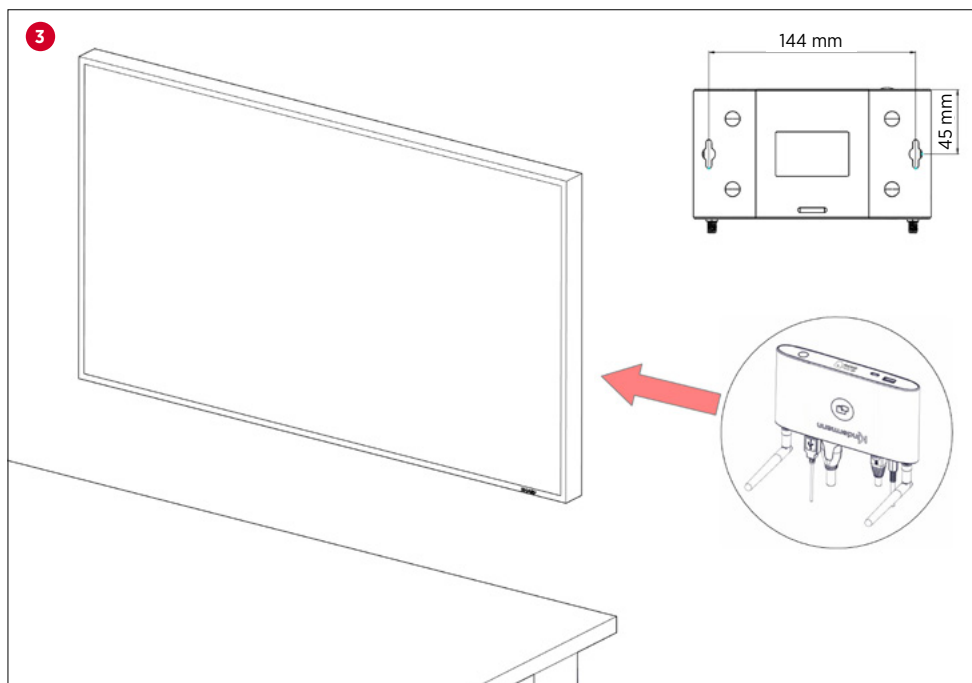
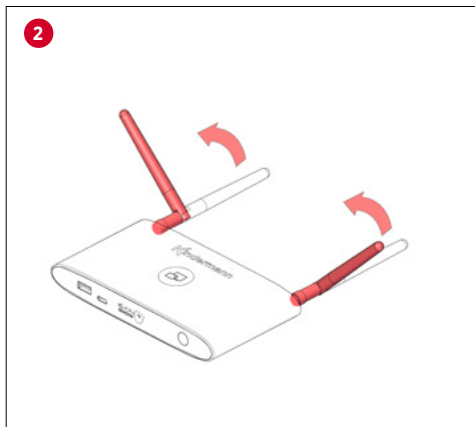
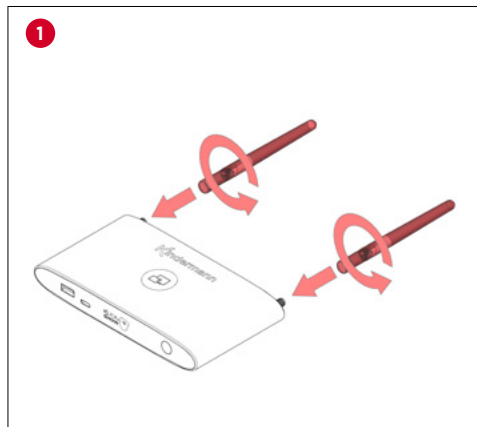

Inbetriebnahme / Start-up / Mise en service / Messa in funzione / Installation / Puesta en marcha / Kurulum / Montaża

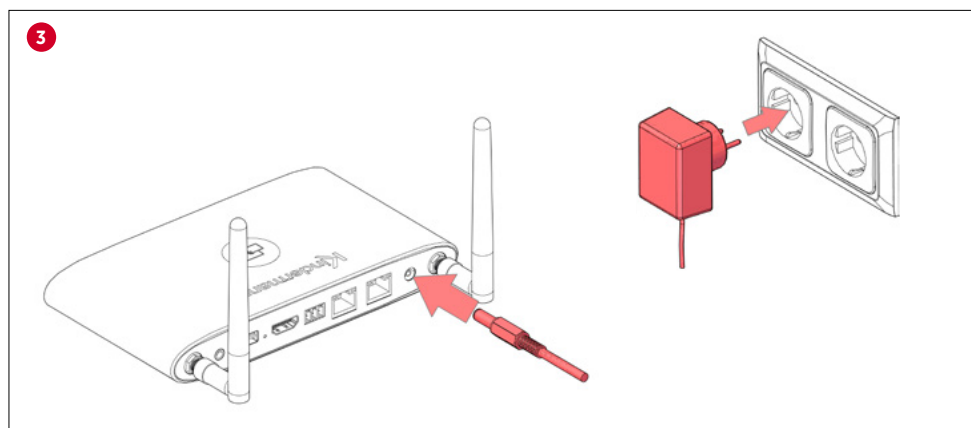
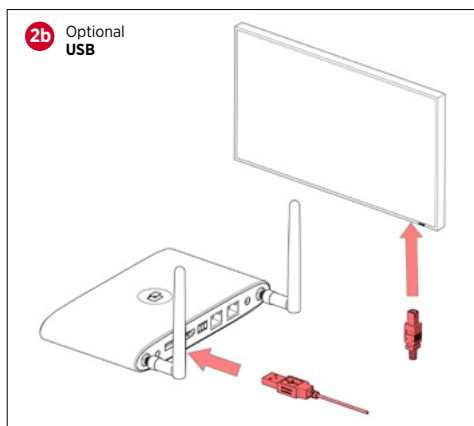
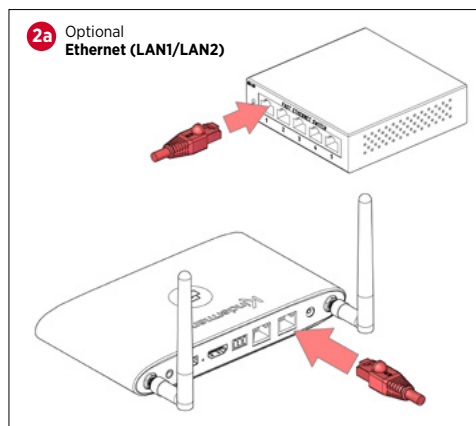
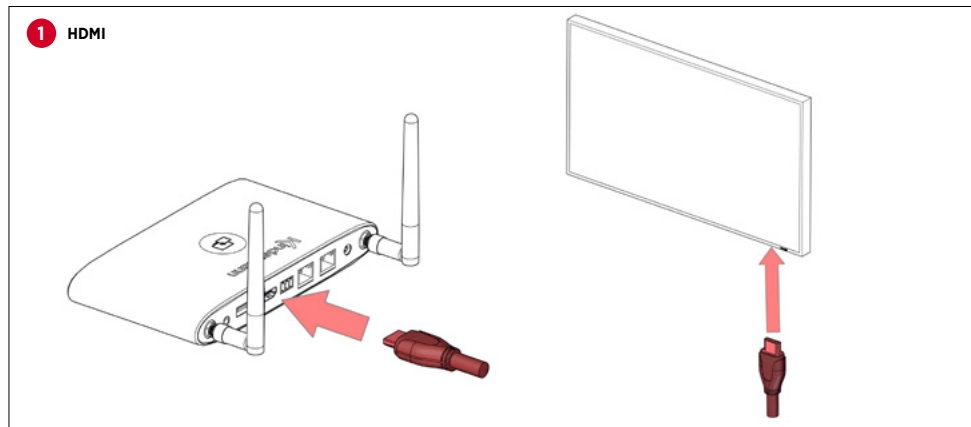



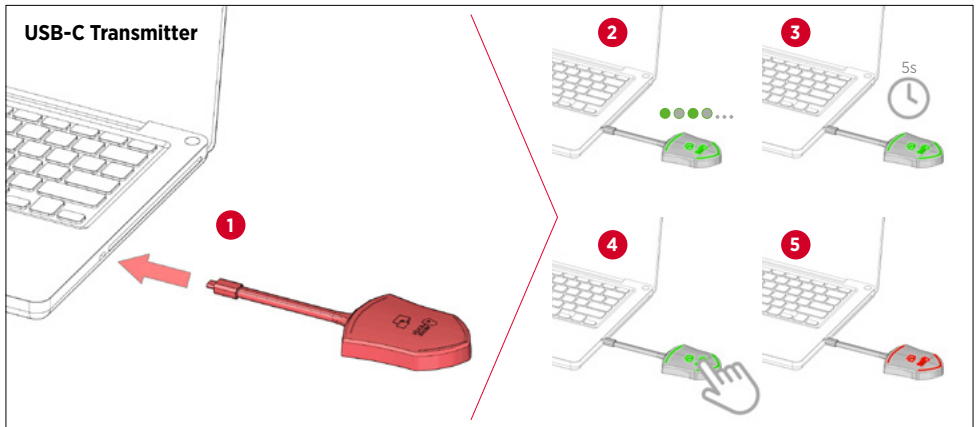
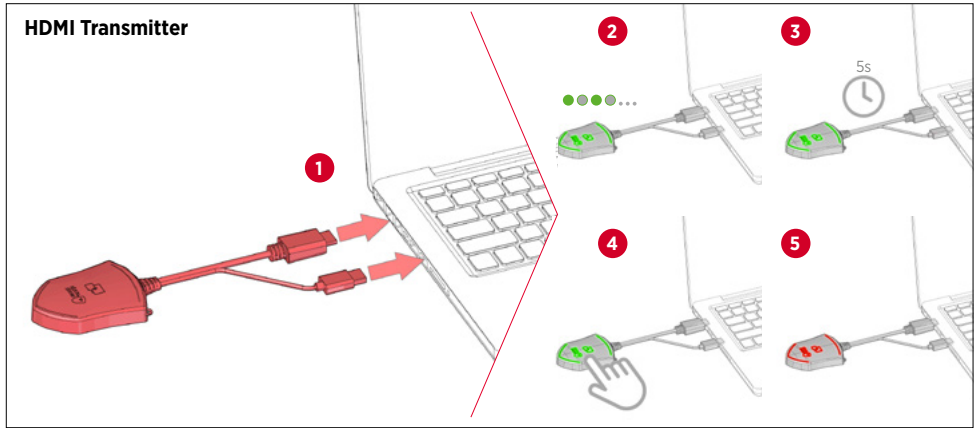

**Mobile Geräte /**  
**Mobile Devices /**  
**Appareils mobiles /**  
**Dispositivi mobili /**  
**Mobiele apparaten /**  
**Mobil cihazlar /**  
**Mobilni uređaji**

|                             |                                 |                                 |                    |
|-----------------------------|---------------------------------|---------------------------------|--------------------|
| Device<br>KlickandShow-5608 | WiFi Guest<br>KlickandShow-5608 | WiFi IP<br>192.168.43.1         | Date<br>11.07.2023 |
| Pin<br>0447<br>42082025     | WiFi Intern<br>Staff 5500       | LAN IP<br>192.168.101.68<br>N/A | Time<br>15:25      |

**SCREENSHARING**

PW: 42082025

1. Connect to WiFi

WirelessMedia2

Airplay

Miracast / Chromecast

2. Use your preferred service to share

Klick and Show

Use via Transmitter

Use via Software

Use via Mobile Devices

Kindermann®

## Download WirelessMedia Client

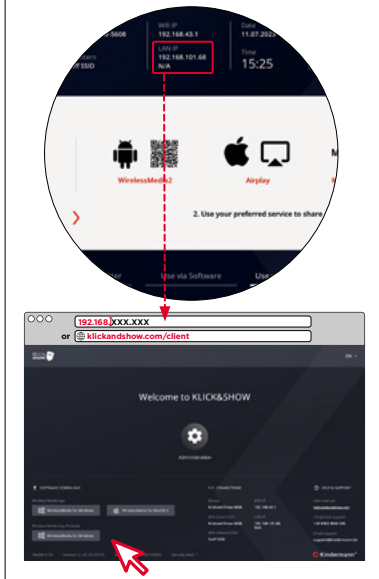

Software Client starten / Start software client /  
Lancer le client logiciel / Avviare il client software /  
Starta programvaruklient / Inicie el software cliente /  
İstemciyi başlatın / Pokrenite softverski klijent

> 7488000310 / 7488000315

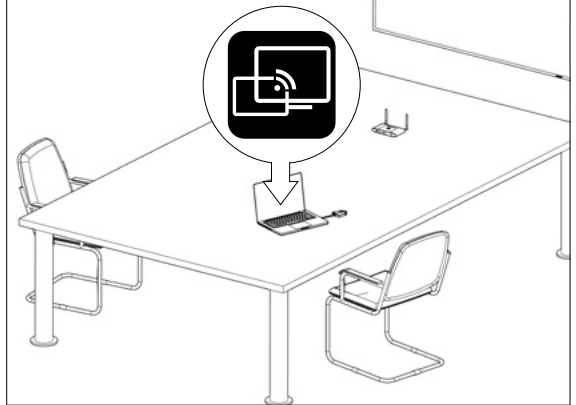

## USB-A Transmitter

Optional erhältlich in bestimmten Ländern /  
Optionally available in certain countries /  
Disponibile en option dans certains pays /  
Disponibile come opzione in alcuni paesi /  
Disponibile opcionalmente en algunos países /  
İsteğe bağlı olarak belirli ülkelerde mevcuttur /  
Opcionalisan elérhető bizonyos országokban

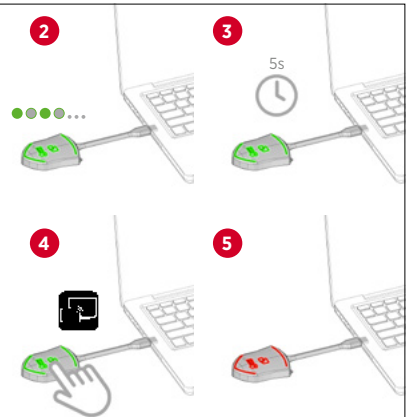
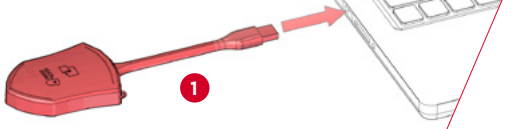

## Fullscreen

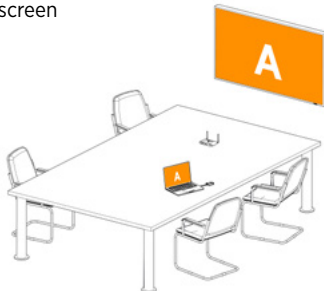

## Splitscreen

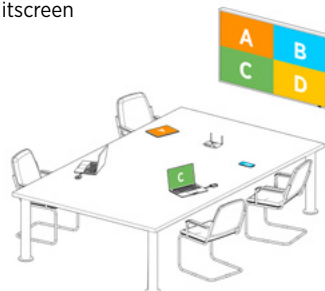

## CE Erklärung

Hiermit erklärt die Kindermann GmbH, dass der Funkanlagentyp Klick&Show der Richtlinie 2014/53/EU entspricht. Die jeweils aktuelle EU-Konformitätserklärung ist unter der folgenden Internetadresse verfügbar:

## Declaration of conformity CE

Hereby, Kindermann GmbH declares that the radio equipment type Klick&Show is in compliance with Directive 2014/53/EU. The full text of the EU declaration of conformity is available at the following internet address:

## Declaration of conformity UKCA

Hereby, Kindermann GmbH declares that the radio equipment type Klick&Show is in compliance with Directive 2014/53/EU. The full text of the UKCA declaration of conformity is available at the following internet address:

## Déclaration de conformité EU

Le soussigné, Kindermann GmbH, déclare que l'équipement radioélectrique du type Klick&Show est conforme à la directive 2014/53/EU. Le texte complet de la déclaration EU de conformité est disponible à l'adresse internet suivante:

## Dichiarazione di conformità EU

Il fabbricante, Kindermann GmbH, dichiara che il tipo di apparecchiatura radio Klick&Show è conforme alla direttiva 2014/53/EU. Il testo completo della dichiarazione di conformità U E U E è disponibile al seguente indirizzo Internet:

## Conformiteitsverklaring EU

Hierbij verklaar ik, Kindermann GmbH, dat het type radioapparatuur Klick&Show conform is met Richtlijn 2014/53/EU. De volledige tekst van de EU-conformiteitsverklaring kan worden geraadpleegd op het volgende internetadres:

## Declaración EU

Por la presente, Kindermann GmbH, declara que el tipo de equipo radioeléctrico Klick&Show es conforme con la Directiva 2014/53/EU. El texto completo de la declaración EU de conformidad está disponible en la dirección Internet siguiente:

## Direktife EU

Iş bu belge ile Kindermann GmbH kablosuz sistem tipin Klick&Show 2014/53/AB sayılı direktife uygun olduğunu beyan eder. AB Uygunluk Beyanının tam metni aşağıdaki internet adresinde incelenebilir:

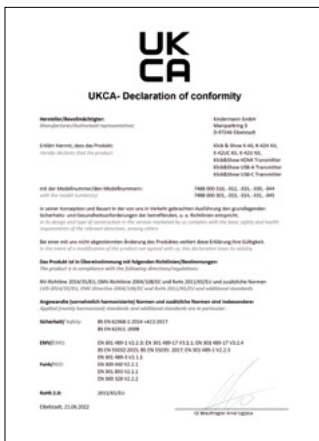
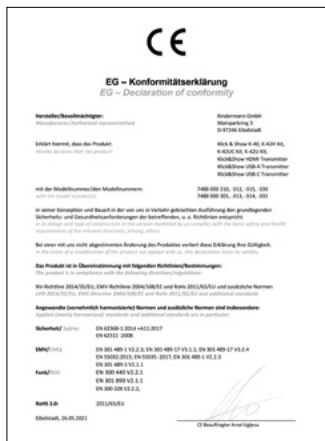

## CE-Zertifikat

Kindermann GmbH ovim izjavljuje da je radio oprema tipa Klick&Show u skladu s Direktiva 2014/53/EU. Kompletan tekst EU izjave o sukladnosti dostupan je na sjedećoj internetskoj adresi:



## Frequenzband

Wenn die Kanäle 36-48 mit dem 5 GHz-Band verwendet werden, ist eine Benutzung dieses Produktes nur in geschlossenen Räumen erlaubt.

**Frequenzband: 2.4 GHz:** Kanäle 1, 2, 3, 4, 5, 6, 7, 8, 9, 10, 11 / **5 GHz:** Kanäle 36, 40, 44, 48

**Bandbreite:** 20 MHz

**Abgestrahlte maximale Sendeleistung:** max. 13 dBm (20 mW), dynamisch gesteuert

---

## Frequency band

When the channels 36-48 are used with the 5 GHz band, this product is restricted only for indoor usage.

**Frequency band: 2.4 GHz:** Channels 1, 2, 3, 4, 5, 6, 7, 8, 9, 10, 11 / **5 GHz:** Channels 36, 40, 44, 48

**Bandwidth:** 20 MHz

**Transmission power:** max. 13 dBm (20 mW), controlled dynamically

---

## Bande de fréquence

Si les canaux 36-48 sont employés dans le réseau Wi-Fi 5GHz, ce produit ne doit être utilisé que dans des espaces fermés.

**Bande de fréquence: 2.4 GHz:** Canaux 1, 2, 3, 4, 5, 6, 7, 8, 9, 10, 11 / **5 GHz:** Canaux 36, 40, 44, 48

**Bande passante:** 20 MHz

**Puissance de transmission:** max. 13 dBm (20 mW), contrôlé dynamiquement

---

## Banda di frequenza

Se si utilizzano i canali 36-48 con WiFi 5GHz, il prodotto può solo essere utilizzato in locali chiusi.

**Banda di frequenza: 2.4 GHz:** Canali 1, 2, 3, 4, 5, 6, 7, 8, 9, 10, 11 / **5 GHz:** Canali 36, 40, 44, 48

**La larghezza di banda:** 20 MHz

**Potenza di trasmissione:** max. 13 dBm (20 mW), controllato dinamicamente

---

## Frequentieband

Indien de kanalen 36-48 in een 5GHz WLAN worden gebruikt, dan mag het product alleen in gesloten

**Frequentieband: 2.4 GHz:** Kanalen 1, 2, 3, 4, 5, 6, 7, 8, 9, 10, 11 / **5 GHz:** Kanalen 36, 40, 44, 48

**Bandbreedte:** 20 MHz

**Zendvermogen:** max. 13 dBm (20 mW), dynamisch geregeld

---

## Banda de frecuencia

Si se emplean los canales 36-48 en la red WLAN de 5 GHz, el product solo deberá utilizarse en espacios cerrados.

**Banda de frecuencia: 2.4 GHz:** Canales 1, 2, 3, 4, 5, 6, 7, 8, 9, 10, 11 / **5 GHz:** Canales 36, 40, 44, 48

**Ancho de banda:** 20 MHz

**Poder de transmision:** max. 13 dBm (20 mW), controlado dinámicamente

---

## Frekans bandi

5GHz WLAN ağında 36-48 kanalları kullanıldığında, ürün yalnızca kapalı mekanlar içerisinde kullanılmalıdır.

**Frekans bandı: 2.4 GHz:** Kanalları 1, 2, 3, 4, 5, 6, 7, 8, 9, 10, 11 / **5 GHz:** Kanalları 36, 40, 44, 48

**Bant genişliği:** 20 MHz

**İletim gücü:** max. 13 dBm (20 mW), dinamik olarak kontrol edilir

---

## Spektar frekvencija

Kada se kanali 36-48 koriste s opsegom 5GHz, ovaj je proizvod ograničen samo na unutarnju upotrebu.

**Frekvencijski pojas: 2.4 GHz:** Kanali 1, 2, 3, 4, 5, 6, 7, 8, 9, 10, 11 / **5 GHz:** Kanali 36, 40, 44, 48

**Širina pojasa:** 20 MHz

**Snaga prijenoša:** max. 13 dBm (20 mW), kontrolirano dinamički

For indoor use ONLY, when operating in 5 GHz-band!



|    |    |    |    |    |    |    |
|----|----|----|----|----|----|----|
| AT | BE | BG | CH | CY | CZ | DE |
| DK | EE | EL | ES | FI | FR | HR |
| HU | IE | IS | IT | LI | LT | LU |
| LV | MT | NL | NO | PL | PT | RO |
| SE | SI | SK | TR | UK |    |    |

## FCC Compliance Statement

This device complies with part 15 of FCC Rules. Operation is subject to the following two conditions:

1. this device may not cause harmful interference, and
2. this device must accept any interference received, including interference that may cause undesired operation.

This equipment has been tested and found to comply with the limits for a Class B digital device, pursuant to part 15 of the FCC Rules. These limits are designed to provide reasonable protection against harmful interference in a residential installation. This equipment generates, uses, and can radiate radio frequency energy, and if not installed and used in accordance with the instructions, may cause harmful interference to radio communications.

However, there is no guarantee that interference will not occur in a particular installation. If this equipment does cause harmful interference to radio or television reception, which can be determined by turning the equipment off and on, the user is encouraged to try to correct the interference by one or more of the following measures:

- > Reorient or relocate the receiving antenna.
- > Increase the separation between the equipment and receiver.
- > Connect the equipment into an outlet on a circuit different from that to which the receiver is connected.
- > Consult the dealer or an experienced radio/TV technician for help.



### Warning:

You are cautioned that changes or modifications not expressly approved by the party responsible for compliance could void your authority to operate the equipment.

**Base unit FCC ID:** 2AWJK-WMS-40

**HDMI Transmitter FCC ID:** 2AWJK-WMT3-H

**USB-C Transmitter FCC ID:** 2AWJK-WMT-C1





**Kindermann GmbH**

Mainparkring 3 | D-97246 Eibelstadt | Germany

Email: [info@kindermann.de](mailto:info@kindermann.de)

Subject to alterations | 7488 000 3xx | DE/GB/FR/IT/SE/ES/TR/HR | 07.2023

[www.kindermann.com](http://www.kindermann.com)