

DC450

"User Manual"

Visualizer
Document
Camera

English

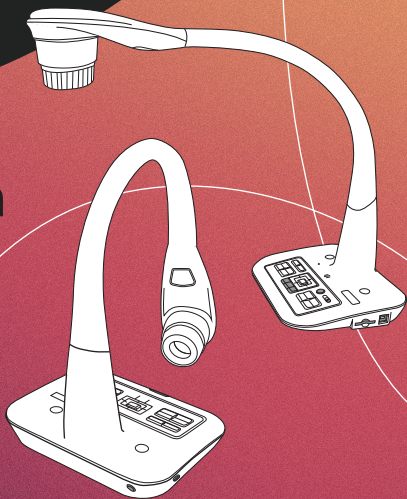

- **Welcome:**

Thanks for purchasing this product. Please read the instructions carefully before using this product.

- **FCC Compliance Statement (Class A):**

This device complies with Part 15 of the FCC Rules. Operation is subject to the following two conditions: (1) this device may not cause harmful interference, and (2) this device must accept any interference received; including interference that may cause undesired operation.

- **Federal Communications Commission (FCC) Statement :**

This Equipment has been tested and found to comply with the limits for a Class A digital device, pursuant to Part 15 of the FCC rules. These limits are designed to provide reasonable protection against harmful interference when the equipment is operated in a commercial environment. This equipment generates, uses and can radiate radio frequency energy and, if not installed and used in accordance with the instructions, may cause harmful interference to radio communications. Operation of this equipment in a residential area is likely to cause harmful interference in which case the user will be required to correct the interference at his own expense.



- **European Community Compliance Statement (Class A):**

This is a class A product. In a domestic environment this product may cause radio interference in which case the user may be required to take adequate measures.



The symbol of the crossed out wheeled bin indicates this product should not be placed in municipal waste. Instead, you need to dispose of the waste equipment by handing it over to a designated collection point for the recycling of waste electrical and electronic equipment.



Warning

1. Do not look directly at the LED light source, which may cause retinal damage.

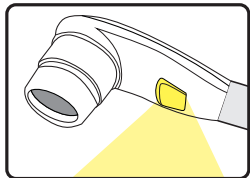

2. Carry the product by holding the base of the main unit in both hands. Never hold the product by the arm or the camera head only.

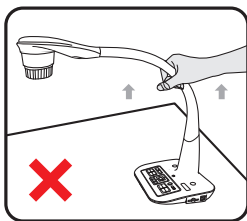
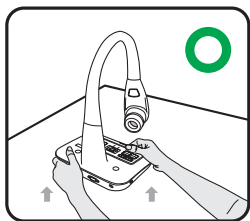

3. The camera can be damaged if it hits a desk surface or any hard object.

4. Never turn the arm in the opposite direction.

5. Be sure to keep one hand on the device base when adjusting the arm and camera head.

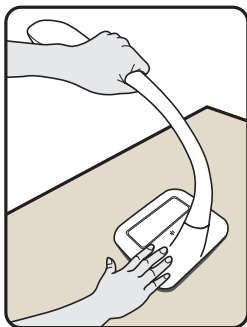

Preparing the Document Camera

● Knowing the Document Camera Parts

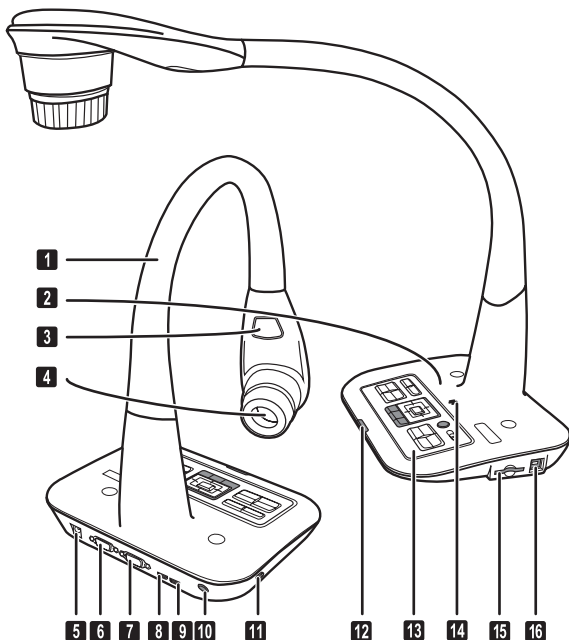





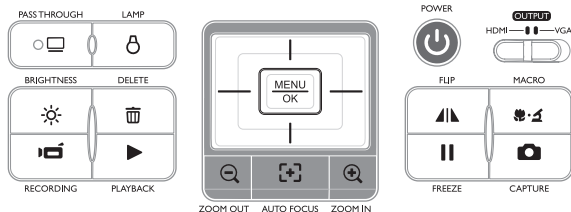













- | | |
|----------------------|-----------------------------------|
| 1 Gooseneck Arm | 9 HDMI Input Port |
| 2 Microphone | 10 Remote Control Signal Receiver |
| 3 LED Lamp | 11 Anti-theft Slot |
| 4 Camera Head | 12 Remote Control Signal Receiver |
| 5 DC 5V Power Socket | 13 Control Panel |
| 6 VGA Output Port | 14 Speaker |
| 7 VGA Input Port | 15 SD Card Slot |
| 8 HDMI Output Port | 16 USB Port |



● Control Panel



Button	Function	Button	Function
	Power On/Off.		Zoom out
	Invert image 180°.		Zoom in
	Macro/Normal switch.		One-time auto focus
	Freeze the current image.		Pass the signal from PC via RGB input port to RGB output port.
	Capture a still image.		Turn on/off the LED lamp and adjust the brightness.
	Show menu and select.		Show/hide brightness adjustment bar.
	Direction keys		Delete one file from memory when in playback mode.
	HDMI - VGA Output Switch		Record a video clip.
			Enter playback mode to display recorded pictures and video clips.

● Remote Control

Button	Function
	Brightness hotkey
	Power on / off
	Freeze current image. * Pause the clip while playing videos
ICON	Show or hide on-screen icons
	To show or hide OSD menu
	Playback mode to display recorded pictures and video clips
	Invert image 180°
	Select and adjust
	Record a video clip
	Capture a still image
	Zoom out / Zoom in
	One-shot auto focus
	Use the level bar to adjust the focus manually
	2X or 4X digital zoom
	Highlight function on / off
	Mask function on / off
	Macro / Normal switch
	Adjust highlighted / masked area size
	Set color for highlighted / masked area

Button	Function
	Increase / decrease the sound volume.
	Picture in Picture function on / off *For displaying a still image as an insert while displaying another image.



- ❗ Infrared remote control can only be used in proximity to the unit.
- ❗ Remove the battery cover and load the batteries into the battery compartment correctly according to the "+" and "-" symbols.
- ❗ Be sure to use two AAA batteries. Do not use new and old batteries or different battery types together.

Setting Up

This section provides useful tips on how to adjust the document camera smoothly for your needs.

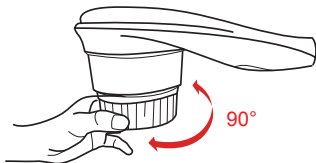

● Rotate Function

Roll the lens rotator to rotate image 90°



● Illumination Lamp

If you are in a dark environment, please turn the LED lamp on to make better exposure.

1. Press the LED lamp button () on the base to turn on/off the LED lamp.
2. Adjusting the brightness by pressing the lamp button ()

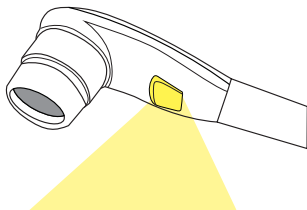

● Output Switch

Adjust the Output Switch on the control panel according to your output port.

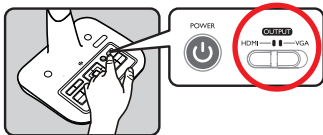

● Gooseneck Arm

The gooseneck arm can be adjusted to support various working areas.

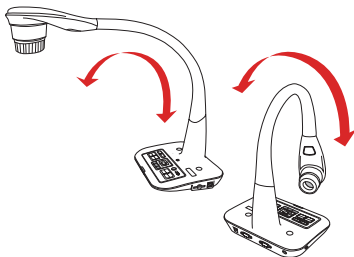

● Working Area

► working area

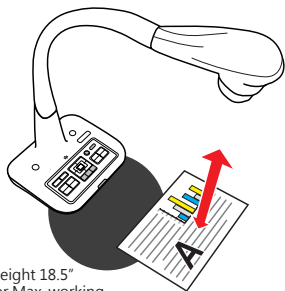
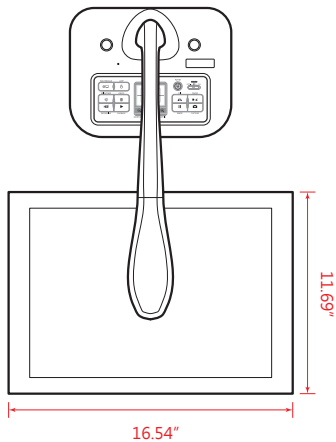

Height 18.5"
for Max. working
(16.54" x 11.69")

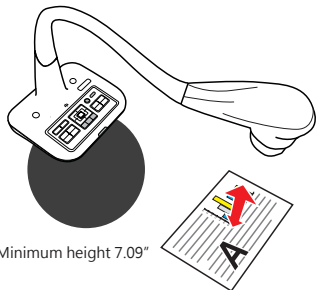
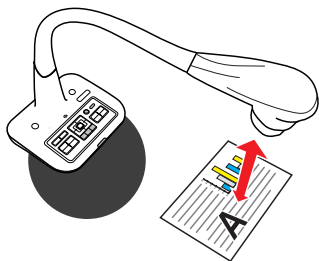

Minimum height 7.09"

❗ If the document is not put in the recommend working area, the image should be rotated

by FLIP button (🔄) on control panel or remote control.

● Adjusting the brightness

1. Press BRIGHTNESS button on the control panel (-☀-) or remote control (☀).
2. Use (◀ or ▶) buttons to increase or decrease the brightness level.

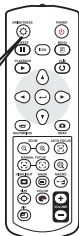
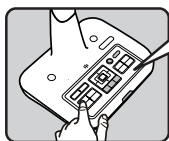

● Zoom Function

Use the Zoom buttons (⊕ / ⊖) to zoom in or zoom out the screen.

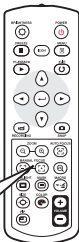
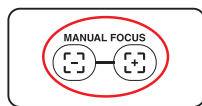
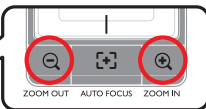
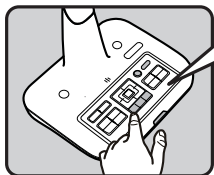

● Flip Function

Press the Flip Button (▲/▼) to flip image

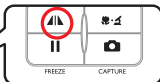
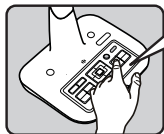

● Adjusting the Focus

▶ Automatic Focus

Press AF button (AF) to do an one-time auto focus. This function provides a one-time auto-focus.

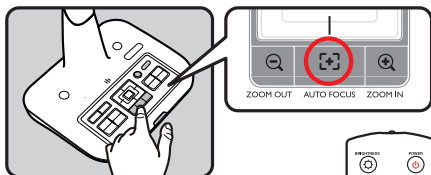

▶ Manual Focus

Use the manual focus buttons ([-]/[+])(★) on remote control to finetune the focus.



● Anti-glare

Anti-glare sheet is a transparent plastic that is overlaid on top of shiny object or glossy surface to reduce the glare.

To use, simply place the anti-glare sheet on top of shiny object to glossy surface such as magazine to reduce light reflection.

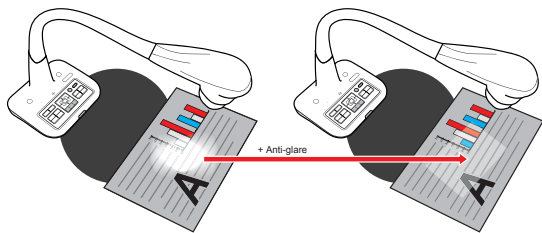

● Adjust the White Balance

1. Default white balance setting of the document camera is "Auto" .
2. There are various modes (Auto, Flurescent, Tungsten and Custom) for user to choose and fit in different surroundings.
3. Custom white balance:

Press "MENU" ($\frac{\text{MENU}}{\text{OK}}$) button → White Balance → enter "Custom" mode.
There will have a pop out window as the picture below:

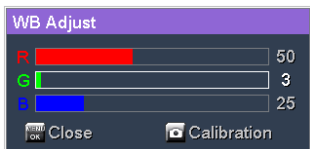

Press CAPTURE () button to get the data of the current image.

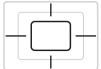
Use the " Direction Key" () to adjust the number of R, G and B parameters.

Press " OK" ($\frac{\text{MENU}}{\text{OK}}$) button to finish setting and close the pop out window.

● Inserting and Ejecting a SD / SDHC card (Not supplied)

1. Insert a memory card (SD/SDHC/MMC/MMC 2.0) with the label facing up until it reaches the end of the slot.
2. When the card is inserted successfully, the icon () will appear on screen and the internal memory will become inaccessible.
3. To remove the card, push the card to release it and then pull it out gently.

- ❗ When using a new memory card, you are recommended to format the card with the device. Do not turn off the device while formatting the SD card.
- ❗ Even if your card has been formatted on other devices, you may have to reformat the card with the device.
- ❗ If no external storage devices are connected, all files will be saved in the built-in memory.

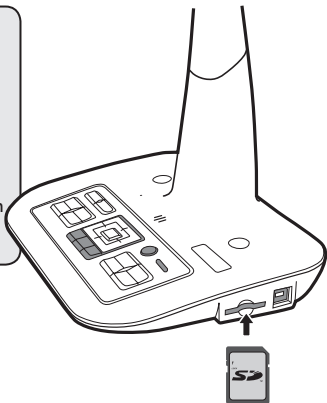

Making the Connections

● System Diagram

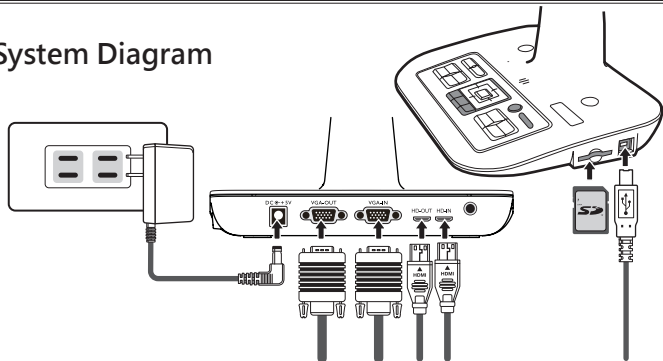

Step 1 / Plugging in the Power Outlet

Use power adapter to connect DC IN connector on the product to a standard 100V~240V AC power outlet.

! The type of power adapter is depending on your countries / regions.

















Step 2 / Output Resolution and Aspect Ratio.

Various output resolutions are available depending on the output and aspect ratio setting. Please refer to the table listed below :

Out put	Aspect-Ratio	Resolution	Vertical Frequency
VGA	4:3	1024 x 768	50 / 60 Hz
		1600 x 1200	
HDMI	16:9	1280 x 720	50 / 60 Hz
		1920 x 1080	

*Document camera will downgrade the output resolution automatically when the connected display device doesn't support highest resolution.

Step 2 / Connecting with Components

	Product Port	Cable	Display Device Port	PC Port
VGA	 RGB OUTPUT		 RGB INPUT	
	 RGB INPUT			 RGB OUTPUT
HDMI	 Mini HD OUT		 HDMI-IN	
	 Mini HD IN			 HDMI-OUTPUT
USB	 TYPE B Port		 TYPE A Port	 TYPE A Port

► Standard TV and Projector

• Connect via VGA OUTPUT

To display images, you can use VGA cable to connect to your television's RGB port via the VGA OUT connector.

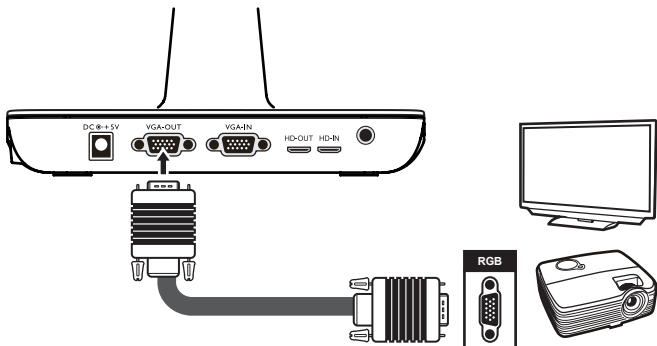

● Connect to a computer

► Passthrough Function

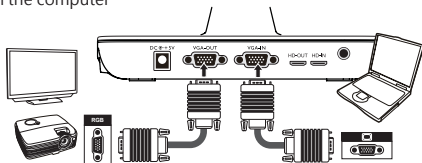

Use VGA Cable to connect VGA IN connector on the document camera to the VGA OUT connector on the computer



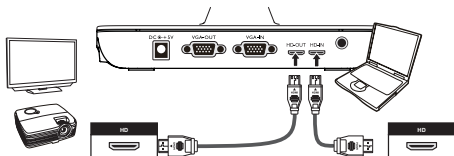

► Use HDMI Cable to connect HDMI IN

Connector on the document camera to the HDMI Out connector on the computer.



- ❶ To display computer image, press PASSTHROUGH button () on the control panel.
- ❷ For laptop to output display mode, use the keyboard command (Fn + ) to switch between the display modes. For different command, please refer to your laptop manual.
- ❸ The signal is only pass through from VGA IN port to VGA OUT port or HDMI In port to HDMI Out port on document camera.
Please connect an output device to display the image on computer.

► Connect via USB



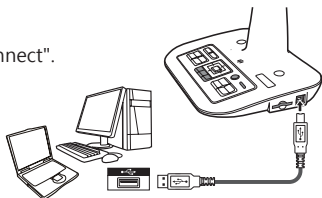













Press MENU ( / ) button → select "USB Connect".
Choose "Disk" to connect mass storage.
Choose "PC Cam" to use as a PC-Cam.

















Basic Operation







1. Press MENU button on the remote control () or control panel ($\frac{\text{MENU}}{\text{OK}}$).
2. Press (\blacktriangleleft or \blacktriangleright) button to toggle between tabs.
3. Press OK button on the remote control (\blackleftarrow) or control panel ($\frac{\text{MENU}}{\text{OK}}$) to make a selection and display the setting selections.
4. Use (\blacktriangleleft or \blacktriangleright) to adjust the setting.
5. Press OK button on the remote control (\blackleftarrow) or control panel ($\frac{\text{MENU}}{\text{OK}}$) to make the new setting activate.
6. Press MENU button on the remote control or EXIT on the OSD menu to hide the OSD menu.

● Menu options in Preview Mode

Name	icon	Option	Description
Brightness		-	Use the Right / Left buttons to make the image brighter / darker
Effect		Graphic	To improve the tint of color-based subjects such as pictures or figures.
		Text	The function is designed especially for text-based documents to which can be enhanced white and black subjects such as characters and lines.
		B&W	To output a black & white camera image.To make the image easier to view,select this when shooting black & white documents etc.
		Negative	To output a negative camera image.
		Sketch	To output a sketch camera image.
White Balance		Auto	There are various modes (Auto, Flurescent, Tungsten and Custom) for user to choose and fit in different surroundings.
		Fluorescent	
		Tungsten	
		Custom	
Quick Zoom		2X / 4X	Set the quick zoom to 2X or 4X.
Focus		Normal	Select standard mode for 25cm ~ ∞.
		Macro / Microscope	Select Macro/Microscope mode to take close-ups or while connecting to a microscope.
Image Size		0.8M / 2M 5M / 8M	Select the desired still image resolution.
Video Mode		High Quality	Select the desired video quality.
		High Frame Rate	

Name	icon	Option	Description	
SETTING	Beep		On / Off	Enable beep sound on / off
	Flicker		50Hz / 60Hz	Set flicker frequency to 50Hz or 60Hz. The flicker setting is based on the frequency standard of your local power supply.
	USB Connect		Off	Disable USB function
			Disk	Select "Disk" to enter Mass storage Mode
			PC cam	Select "PC Cam " to enter PC Cam Mode
	HDMI Out		720p	Adjust HD-OUTPUT resolution
			1080i	
	VGA Out		XGA	Adjust VGA-OUTPUT resolution
			UXGA	
	Clock		-	Set date and time
	Language		-	Allows you select the language used for OSD
	Format		No / Yes	Format the storage medium. Note that all files stored in the medium will be gone.
Reset default		No / Yes	Restore factory defaults. Note that your current settings will be overwritten.	
Exit		-	Exit Menu.	

● Menu options in Playback Mode

Name	icon	Option	Description
Delete one		Yes / No	Delete current file.
Delete all		Yes / No	Delete all images of the same type stored in the memory.
Slide show		On / off	Start / Stop Slide Show
File Info		-	View the file' s title , saved date and time , size and the length of recording.
Volume		-	Adjust playback video volume.
Camera		-	Exit playback mode and back to preview mode.

● Recording a video clip / Taking a still picture

1. Set the capture or record resolution.

according to the setting, please refer to the table below:

Output Switch	Resolution Setting	Capture resolution	Recording resolution
VGA	XGA	1024 x 768	1024 x 768
	UXGA	1600 x 1200	
HDMI	720P	1280 x 720	1280 x 720
	1080i	1920 x 1080	1920 x 1080

2. Choose the focus mode according to distance to object:

Normal mode for 25cm to ∞.

Macro mode (🌸) or (🔍)(★) to take close - ups.



3. Use the Zoom button (⊕/⊖) to zoom in or zoom out from the screen.

4. Automatic focus/Manual focus

Press AF button (⊕) to do one-time auto-focus.

Use manual focus button (⊖/⊕)(★) on the remote control to fine-tune focus.

5. Press the Recording button (📹) to start recording and press it again to stop recording. Press the Capture button (📷) to take a still picture.

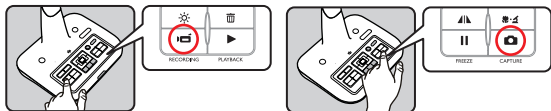

● Playback

1. Press PLAYBACK button (▶).

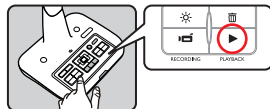

2. The last recorded picture or video clip will show on the screen.
3. Use Up / Down button to choose files.

● Copying Files to Computer

Please notice that the video clips are recorded in AVI format and are compiled as CLIPxxxx.avi (xxxx are four serial numbers).

Before viewing these videos on your PC, you may need to install some media programs.

1. Turn on the document camera.
2. Connect the product to your computer with USB cable.
3. Press MENU ($\frac{\text{MENU}}{\text{OK}}$) → select "USB Connect " → choose "Disk ". The built-in memory or external memory will be detected.

Then, You can view the image data on a SD card on the PC' s viewer software or simply cut/ copy and paste the file to your PC.

⚠ When the operating panel or the remote control is in operation, do not connect or disconnect the USB cable, as this may cause malfunctions of the device to occur.

● Using document camera as a PC cam

Starting the application

1. Connect the product to your computer.
Turn on your computer, then connect the accessory USB cable to the USB port of your computer.
Make sure the connector and the port are aligned correctly.

Switch to PC Cam mode.

Connect the other end of the USB cable to the main unit.

Power on press MENU ($\frac{\text{MENU}}{\text{OK}}$) → Setting → select USB Connect → select PC Cam () and press OK button to confirm.

2. Launch PC Camera
After the product is correctly connected to and detected by your PC, you are ready to use PC Camera function.

Working with Smart DC

1. Make sure the USB connection setting is at "PC-Cam" .
2. Connect device and PC with accessory USB cable.
3. Start Smart DC on your PC.

Advance Operation

● Highlight function / Mask function(★)

Highlight function



1. Use the Highlight function to draw attention to a particular section of the output image.
2. Press the Highlight button () on the remote control, and use the direction buttons to move the highlighted area.

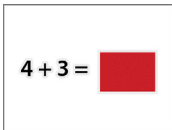

Mask function

1. You can mask a section of the output image.
2. Press the Mask button () on the remote control, and use the direction buttons to move the masked area.



- ❗ Press the Size button () on the remote control, and use the direction buttons to adjust the highlighted / masked size.
- ❗ Press the Color button () on the remote control, and use the direction buttons to adjust the color of highlighted / masked area.

● PIP (Picture in Picture) function(★)

1. Press the PIP button () to display an around quarter-size still image on a live camera display.
2. Use the up or down button to change the shift between still images.

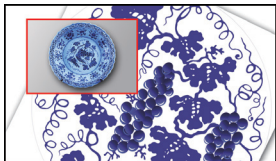

● Connect to a microscope

Connect to a microscope enables you to examine microscopic objects on a big screen.

1. Adjust the microscope and focus objects.
2. Choose an appropriate microscope adapter.
3. Microscope adapter accessories are applicable to $\varnothing 28\text{mm}$, $\varnothing 31\text{mm}$, $\varnothing 33\text{mm}$, and $\varnothing 34\text{mm}$ eyepieces.

- ❗ For eyepieces of about $\varnothing 33\text{mm}$, $\varnothing 34\text{mm}$, only a microscope adaptor should be installed.
- ❗ For a $\varnothing 28\text{mm}$ eyepiece, insert the $\varnothing 28\text{mm}$ adapter into the microscope adapter.
- ❗ For a $\varnothing 31\text{mm}$ eyepiece, insert the $\varnothing 31\text{mm}$ adapter into the microscope adapter.

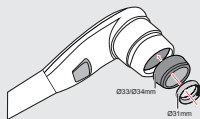
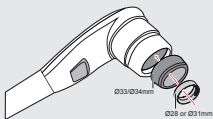
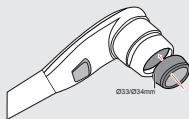

4. Mount / take off the microscope adapter onto / off the lens by doing the action shown in the picture.

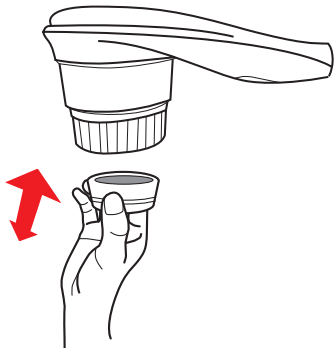

5. Switch the focus mode to Macro.

Press MENU ($\frac{\text{MENU}}{\text{OK}}$) --> select Focus ($\left[\begin{smallmatrix} \oplus \\ \ominus \end{smallmatrix} \right]$) -->

select Macro



or press Macro button ($\left[\begin{smallmatrix} \text{Macro} \\ \text{Microscope} \end{smallmatrix} \right]$) (★) on remote controller.

6. Connect the lens with microscope adapter to the microscope.

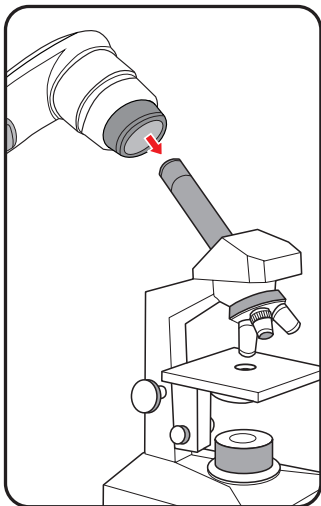

❗ If the image is not clear. Please adjust the focus of microscope.

❗ Press the AF button ($\left[\begin{smallmatrix} + \\ - \end{smallmatrix} \right]$) or use the manual focus button on remote control to fine-tune the focus.

Storing

1. Power off the product.

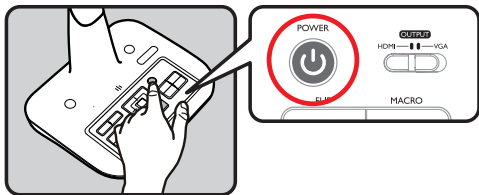

2. Unplug the AC adapter from the wall outlet. Then, disconnected the AC Adapter and all cables.

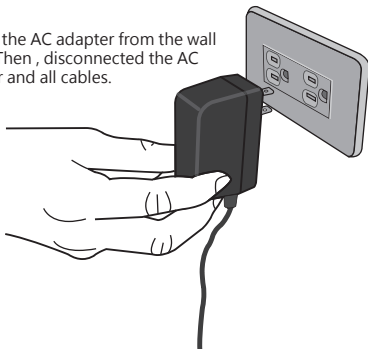

3. Fold the camera head and arms in the direction shown in the figure.

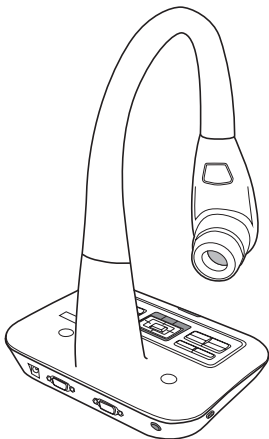

Troubleshooting

When using the document camera :		
Problem	Cause	Solution
Cannot be powered on normally.	The AC adapter is not correctly connected to the wall outlet or the document camera.	Re-connect one end of the AC adapter to the document camera and the other end to a wall outlet.
Cannot take pictures and video clips.	Out of memory.	Free some space from the SD / MMC card or the internal memory.
	Using a "protected" SD card.	Set the SD card to be written in.
No image output after connecting.	The document camera is not correctly connected to the external device.	Re-connect all related cables with the external device correctly.
	Incorrect input type of display output device.	Set up correct input type of display output device.
	Incorrect supported resolution of display output device.	Set up correct supported resolution of display output device.
	Incorrect output port selected by output switch on document camera.	Set up correct output port by output switch.
	PC pass through button indicator is on.	Press [] PASSTHROUGH button to turn off the function.

When using the document camera :		
Problem	Cause	Solution
The image is fuzzy.	Probably the distance of object is too close to the lens.	Press AF button to auto focus or adjust by pressing Manual Focus.
		Select Macro mode if the distance is less 25cm.
The image is reverse.	The document is not put in the recommend working area.	Press [↺] button to adjust the direction.
The image dose not move.	Camera image is set to Freeze [⏸].	Press the [⏸] button on the control panel again to unpaue.
Remote control can not work.	No power.	Replace the AAA batteries in the remote control.
	Object is blocking the remote control signal receiver of the document camera.	Remove obstruction in front of the product.
	The distance of usage is too far.	Stand closer to the product to use the remote control.
The display device displays "MEMORY ERROR" or "CARD ERROR" message. Or memory card cannot be read.	The format of the memory card is not compatible with the product.	Use the "Format" function of the document camera to format the card.
	The memory card is corrupted.	Replace the memory card with a new one.

When using the document camera :

Problem	Cause	Solution
Cannot delete the pictures and video clips, and also cannot find them in the memory card.	The lost recordings are saved in the internal memory.	It happens when you insert a memory card after taking a few pictures or video clips. You can access those files after removing the memory card.
Cannot view the video clips on my computer.	Software is not installed on the computer.	Install Direct X 9.0c or above and Windows Media 9.0 Co-decs to solve this problem. Go to the website " http://www.microsoft.com " to download the required files. Please refer to "Copying files to your computer" .
TV screen does not display after connecting the product to TV.	The product is not correctly connected to the TV.	Reconnect the product to TV correctly.
Noises occur when viewing images on the computer.	The flicker setting does not match the standard of the country you are staying.	Adjust the flicker setting .

⚠ The contents in this manual are subject to change without prior notification.

DC450

Bedienungsanleitung

Dokumenten
kamera

Deutsch



- **Willkommen:**

Vielen Dank für den Kauf dieses Produktes. Bitte lesen Sie die Bedienungsanleitung aufmerksam durch, bevor Sie Ihr neues Gerät benutzen.

- **FCC-Einhaltungserklärung (Klasse A):**

Dieses Gerät erfüllt Teil 15 der FCC-Regularien. Der Betrieb unterliegt den folgenden beiden Voraussetzungen: (1) Dieses Gerät darf keine Störungen verursachen. (2) Dieses Gerät muss jegliche empfangenen Störungen hinnehmen, einschließlich Störungen, die zu unbeabsichtigtem Betrieb führen können.



- **Erklärung der Federal Communications Commission (FCC) :**

Diese Ausrüstung wurde getestet und mit den Grenzwerten für Digitalgeräte der Klasse A gemäß Teil 15 der FCC-Regularien übereinstimmend befunden. Diese Grenzwerte wurden geschaffen, um angemessenen Schutz gegen Störungen beim Betrieb in kommerziellen Umgebungen zu gewährleisten. Dieses Gerät erzeugt, verwendet und kann Hochfrequenzenergie abstrahlen und kann - falls nicht in Übereinstimmung mit den Bedienungsanweisungen installiert und verwendet - Störungen der Funkkommunikation verursachen. Beim Betrieb dieses Gerätes in Wohngebieten kann es zu Störungen kommen. In diesem Fall hat der Anwender die Störungen eigenverantwortlich zu beseitigen.

- **EU-Einhaltungserklärung (Klasse A):**

Dies ist ein Produkt der Klasse A. Beim Einsatz in Wohnumgebungen kann es zu Funkstörungen kommen, die eventuell vom Anwender durch angemessene Maßnahmen zu kompensieren sind.



Das Symbol mit der durchgestrichenen Mülltonne bedeutet, dass dieses Produkt nicht mit dem regulären Hausmüll entsorgt werden darf. Stattdessen müssen Altgeräte über spezielle Sammelstellen zum Recycling von elektrischen und elektronischen Altgeräten entsorgt werden.



Warnung

1. Schauen Sie nicht direkt in die LED-Lichtquelle – dies kann die Augen schädigen.

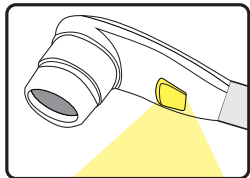

2. Fassen Sie das Gerät beim Tragen mit beiden Händen am unteren Teil des Hauptgerätes. Tragen Sie das Gerät niemals am Arm oder am Kamerakopf.

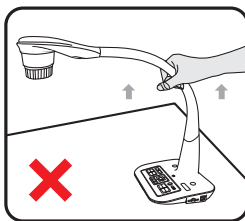
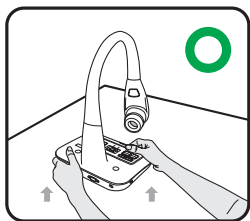

3. Achten Sie darauf, dass der Kamerakopf nicht gegen Tische und andere feste Gegenstände stößt.

4. Versuchen Sie niemals, den Arm in Gegenrichtung zu drehen.

5. Sie müssen das Unterteil des Geräts mit einer Hand festhalten, wenn Sie den Arm und Kamerakopf verstellen.

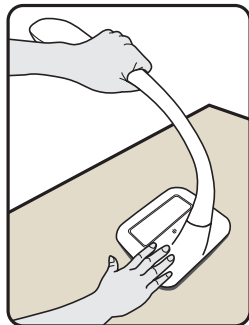

Dokumentenkamera vorbereiten

● Ihre neue Dokumentenkamera

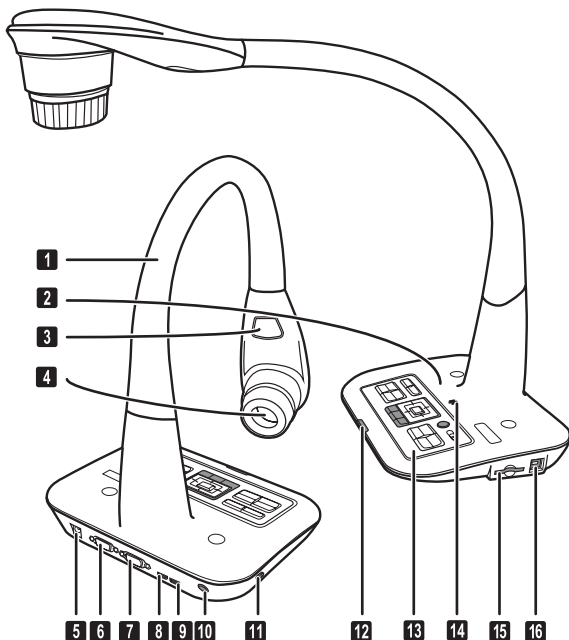

1 Schwanenhals Arm

2 Mikrofon

3 LED-Lampe

4 Kamerakopf

5 5 V DC Anschluss

6 VGA-Ausgang

7 VGA-Eingang

8 HDMI Ausgabe

9 HDMI Eingang

10 IR Empfänger für Fernbedienung

11 Aufnahme für Diebstahlschutz

12 IR Empfänger für Fernbedienung

13 Bedienpanel

14 Lautsprecher

15 SD-Card





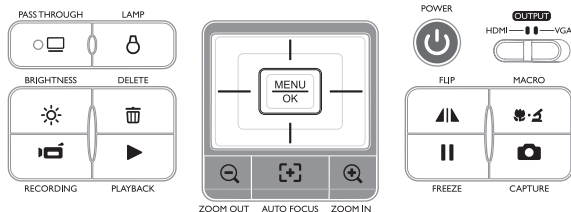













16 USB-Anschluss



● Bedienfeld



Taste	Funktion	Taste	Funktion
	Schaltet das Gerät ein/aus		Verkleinert das Bild
	Kehrt das Bild um 180° um		Vergrößert das Bild
	Makro/Normal-Schalter		Einmaliger Autofokus
	Zeigt das aktuelle Bild als Standbild		Aktiviert den PC-Modus für die „PASSTHROUGH“-Funktion
	Macht eine Fotoaufnahme		Schaltet die LED-Lampe ein/aus und stellt ihre Helligkeit ein
MENU OK	Zeigt das Menü an und bestätigt eine Auswahl		Schnellaste zum Einstellen der Helligkeit
	Richtungstaste		Löscht Dateien im Speicher während des Wiedergabemodus
	HDMI-VGA Umschaltung		Macht eine Videoaufnahme
			Aktiviert den Wiedergabemodus, um Video- und Bildaufnahmen anzuzeigen

Fernbedienung

Taste	Funktion
	Schnelltaste zum Einstellen der Helligkeit
	Schaltet das Gerät ein und aus
	Standbild
ICON	Blendet Symbole im Display ein und aus
	TBlendet das OSD-Menü ein und aus
	Wechselt zur Anzeige aufgenommener Bilder und Videos in den Wiedergabemodus
	Dreht das Bild um 180°
	Mit diesen Tasten nehmen Sie Auswahlen und Einstellungen vor
	Nimmt ein Video auf
	Nimmt ein Standbild auf
	Verkleinert/vergrößert das Bild
	Einmaliger Autofocus
	Mit den Fokustasten („Manual Focus“) der Fernbedienung stellen Sie die Bildschärfe manuell ein
	Vergrößert die Bilddarstellung digital um den Faktor 2 oder 4
	Hervorhebungsfunktion ein/aus
	Maskierungsfunktion ein/aus
	Makro/Normal-Umschalter
	Die Größe hervorgehobener/maskierter Bereiche regeln Sie mit den Richtungstasten
	Die Farbe der Außenbereiche von hervorgehobenen/maskierten Bereichen stellen Sie mit den Richtungstasten ein.

Taste	Funktion
	Erhöht/verringert die Lautstärke
	Schaltet die Bild-im-Bild-Funktion ein und aus. * Zeigt ein verkleinertes Standbild innerhalb eines größeren Bildes an



- ❗ Die Infrarotfernbedienung funktioniert nur in der Nähe des Gerätes
- ❗ Legen Sie die Batterien richtig herum ein; orientieren Sie sich an den Symbolen „+“ und „-“
- ❗ Die Fernbedienung benötigt zwei AAA-Batterien. Verwenden Sie keine neuen und gebrauchten, Batterien gleichzeitig, legen Sie keine Batterien unterschiedlichen Typs ein.

Aufstellen und einrichten

In diesem Abschnitt finden Sie nützliche Tipps zur problemlosen Anpassung der Dokumentenkamera an Ihren persönlichen Bedarf.

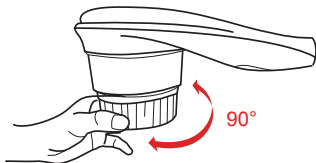

● Bildrotation - Funktion

Drehen Sie am Objektivrad um das Bild um 90° zu drehen



● Leuchte

In einer dunklen Umgebung schalten Sie für eine bessere Belichtung bitte die LED-Lampe ein.

1. Drücken Sie die LED-Lampentaste () am Unterteil, um die LED-Lampe ein-/ auszuschalten.
2. Stellen Sie die Helligkeit durch Drücken der Lampentasten () ein.

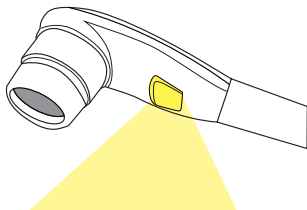

● Ausgang - Umschalter

Stellen Sie den Ausgang-Umschalter auf den von Ihnen gewählten Ausgang.

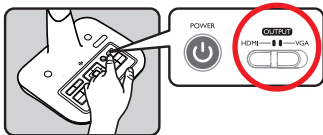

● Schwanenhals

Der Schwanenhals kann für zahlreiche Arbeitsbereiche angepasst werden.

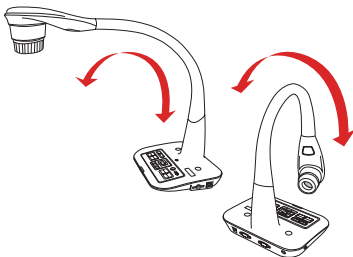

● Arbeitsbereich

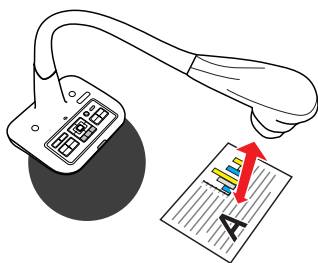
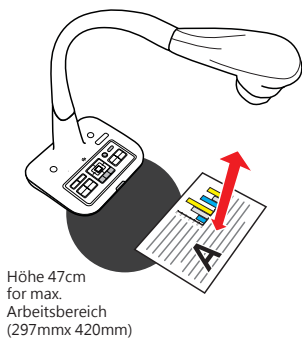
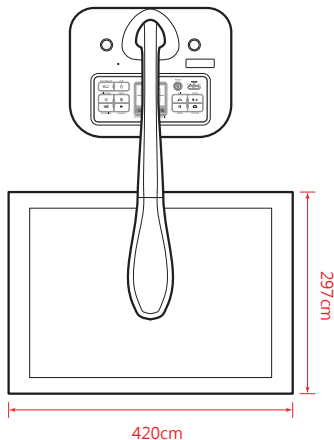

❗ Falls das Dokument nicht in den empfohlenen Arbeitsbereich gelegt wird, sollten Sie das bild mit der FLIP-Taste (🔄) am Bedienfeld oder an der Fernbedienung drehen.

● Helligkeit einstellen

1. Drücken Sie die MENU-Taste und wählen Sie die Helligkeitseinstellung (☀️) (⚙️).
2. Stellen Sie die Helligkeit mit den Tasten (◀️ oder ▶️) auf die gewünschte Intensität ein.

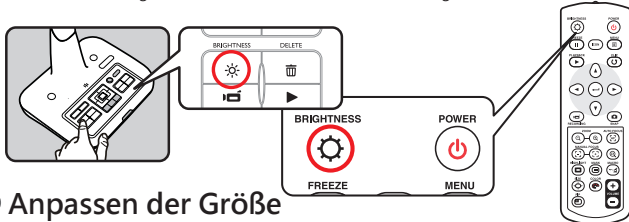

● Anpassen der Größe

Verwendung der Zoom-Tasten, (⊕ / ⊖), verkleinert / vergrößert das Bild.

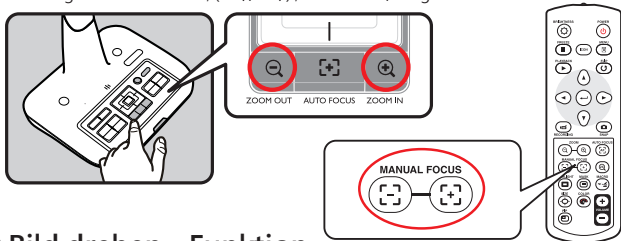

● Bild drehen - Funktion

Drücken Sie die Flip-Taste um das Bild zu drehen

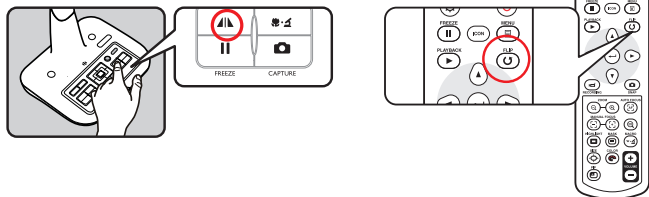

● Fokus einstellen

► Automatischer Fokus

Mit der Autofokustaste (AF) können Sie das Bild einmalig fokussieren.

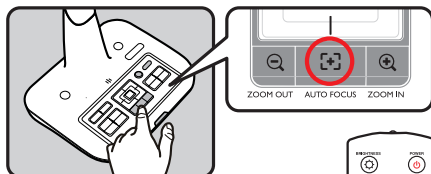

► Manueller Fokus

Mit den Tasten zum manuellen Fokussieren (⌘/⌘)(★) können Sie die Bildschärfe fein abstimmen.



● Antireflex

Mit der Antireflexfolie aus transparentem Kunststoff können Sie Lichtreflexionen weitestgehend verhindern.

Dazu legen Sie die Antireflexfolie einfach über glänzende Objekte (z. B. Hochglanzmagazine), damit es nicht zu Spiegelungen und Lichtreflexen kommt.

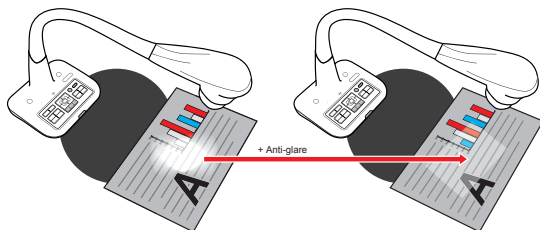

● Stellen Sie den Weißabgleich ein

1. Die Standardeinstellung der Dokumentenkamera für den Weißabgleich lautet "Automatisch" .
2. Es gibt unterschiedliche Modi (Automatisch, Neonlicht, Kunstlicht und Anpassen), passend zu den unterschiedlichen Umgebungen.
3. Weißabgleich anpassen:

Drücken Sie die Taste "Menü" ($\frac{\text{MENU}}{\text{OK}}$) → Weißabgleich → den Modus "Anpassen" aufrufen. Es blendet sich nachstehend abgebildetes Fenster ein:

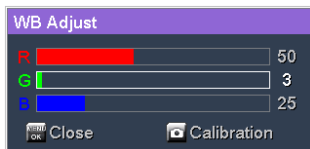

Drücken Sie die Taste Aufzeichnen () , um die Daten des aktuellen Bildes einzulesen.

Stellen Sie mit der "Richtungstaste" () die Werte für die R-, G- und B Parameter ein.

Drücken Sie die Taste " OK" ($\frac{\text{MENU}}{\text{OK}}$) um die Einstellung fertigzustellen und das Einblendfenster zu schließen.

● SD-/SDHC-Karten (separat erhältlich) einlegen und herausnehmen

1. Schieben Sie die Speicherkarte (SD/SDHC/MMC/MMC 2.0) mit der Beschriftung nach oben bis zum Anschlag in den Steckplatz ein.
2. Wenn die Karte richtig eingelegt wurde, erscheint das Symbol () im Display; nun kann nicht mehr auf den internen Speicher zugegriffen werden.
3. Zum Herausnehmen drücken Sie die Karte zunächst ein kleines Stückchen hinein und ziehen Sie sie anschließend komplett heraus.

⚠ Schalten Sie das Gerät beim Formatieren einer Speicherkarte niemals ab.

⚠ Achten Sie darauf, Speicherkarten grundsätzlich mit dem Gerät selbst zu formatieren. Falls Speicherkarten bereits mit anderen Geräten (z. B. Computern) formatiert wurden, müssen Sie diese noch einmal mit Ihrem neuen Gerät formatieren.

⚠ Falls keine externen Speichermedien angeschlossen sind, werden sämtliche Dateien im internen Speicher abgelegt.

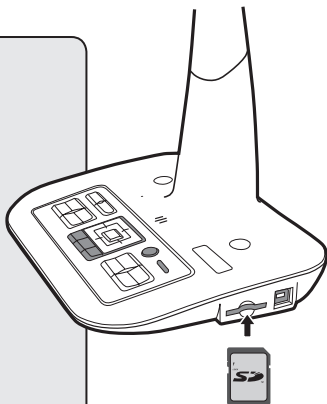

Anschließen

● Systemdiagramm

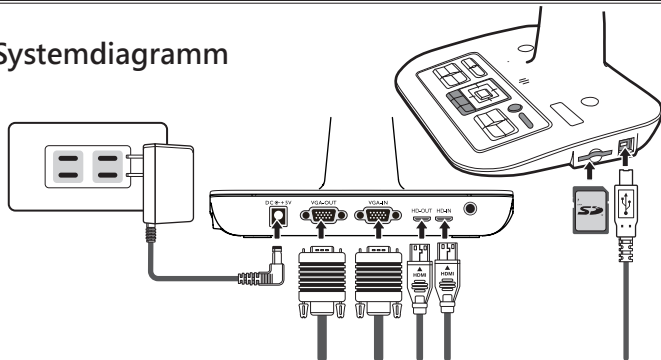

Schritt 1 / Netzteil anschließen

Schließen Sie den Netzteilstecker an den DC IN-Anschluss des Gerätes an, verbinden Sie den Netzstecker des Netzteils mit einer Steckdose (100 – 240 V Wechselspannung).

! Die Art des Netzteils ist von Ihrem Land / Ihrer Region abhängig.

















Schritt 2 / Ausgabe Auflösung und Bildformat Einstellung

Es sind verschiedene Auflösungen verfügbar - abhängig von dem gewählten Ausgang und Bildformat. Bitte beachten Sie die unten aufgeführten Tabelle:

Ausgabe	Bildformat	Auflösung	Vertikale Bildfrequenz
VGA	4:3	1024 x 768	50 / 60 Hz
		1600 x 1200	
HDMI	16:9	1280 x 720	50 / 60 Hz
		1920 x 1080	

*Die Dokumentenkamera wird die Ausgabeauflösung automatisch reduzieren, wenn das angeschlossene Anzeigegerät die höchste Auflösung nicht unterstützt.

Step 3 / Komponenten anschließen

	Product Port	Cable	Display Device Port	PC Port
VGA	 RGB OUTPUT		 RGB INPUT	
	 RGB INPUT			 RGB OUTPUT
HDMI	 Mini HD OUT		 HDMI-INPUT	
	 Mini HD IN			 HDMI-OUTPUT
USB	 TYPE B Port		 TYPE A Port	 TYPE A Port

► Normale Fernsehgeräte

• Anschluss über den VGA-Ausgang (VGA OUTPUT)

Zur reinen Bildanzeige verbinden Sie den VGA OUT-Ausgang des Gerätes über ein VGAKabel mit dem RGB-Eingang des Fernsehgerätes.

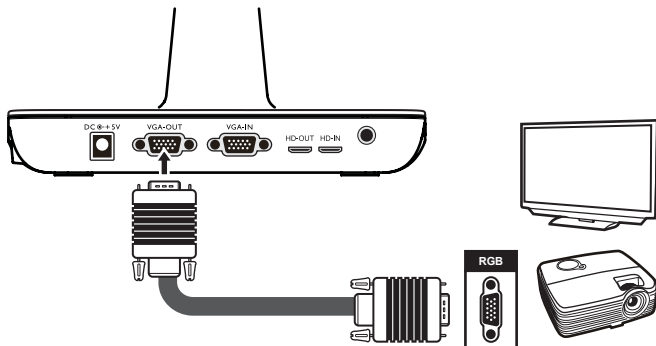

● Computer anschließen

► Anschluss über VGA-Kabel

Verbinden Sie den VGA-Ausgang des Computers über ein VGA-Kabel mit dem VGA IN-Anschluss des Gerätes.

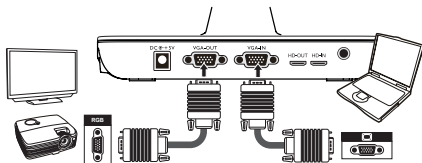

► Verwenden Sie ein HDMI Kabel zur Durchleitung

Verwenden Sie ein HDMI-Kabel am HD-IN-Anschluss der Dokumentenkamera um einen Computer mit HD-OUT-Anschluss zu verbinden.

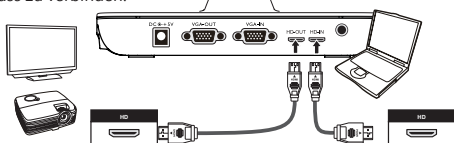

- ❗ Zur Anzeige des Computerbildes drücken Sie die PC-Taste (**PC**) am Bedienfeld.
- ❗ Bei Notebooks oder Netbooks müssen Sie häufig zunächst mit einer Tastenkombination (Fn + **□**) zum externen Anzeigemodus umschalten. Die individuelle Tastenkombination entnehmen Sie bitte der Bedienungsanleitung des Computers.
- ❗ Das Signal wird lediglich vom VGA-Eingang zum VGA-Ausgang der Dokumentenkamera durchgeschliffen. Das Computerbild kann nicht auf dem internen LC-Display dargestellt werden. Schließen Sie daher zur Anzeige von Computerbildern immer ein externes Anzeigegerät an.

► USB-Verbindung

















Drücken Sie die MENU-Taste ($\frac{\text{MENU}}{\text{OK}}$) wählen Sie „USB-Verbindung “. Wählen Sie „Datenträger “, wenn Sie ein Massenspeichergerät nutzen möchten. Wählen Sie „PCKamera “, wenn Sie das Gerät als PC-Kamera einsetzen möchten.

















Grundbedienung







1. Drücken Sie die MENU-Taste () an der Fernbedienung oder am Bedienfeld ($\frac{\text{MENU}}{\text{OK}}$).
2. Mit (\blacktriangleleft or \blacktriangleright) schalten Sie zwischen unterschiedlichen Registern um.
3. Mit ($\frac{\text{MENU}}{\text{OK}}$) treffen Sie Ihre Auswahl oder zeigen unterschiedliche Auswahlmöglichkeiten an.
4. Zum Anpassen von Einstellungen nutzen Sie die Tasten (\blacktriangleleft or \blacktriangleright).
5. Mit ($\frac{\text{MENU}}{\text{OK}}$) übernehmen Sie neue Einstellungen.
6. Blenden Sie das OSD-Menü durch erneute Betätigung der MENU-Taste (MENU), oder Beenden "EXIT" .

● Menüoptionen bei der Vorschau

Element	Symbol	Option	Beschreibung
Helligkeit		-	Mit den Links-/Rechtstasten erhöhen/ vermindern Sie die Bildhelligkeit
Effekt		Grafik	Um der Farbton der farbliche Themen wie in bilder zu verbessern, wählen Sie Grafik.
		Text	Die Funktion ist besonders für textbasierte Dokumente entwickelt, um die sich weiße und schwarze Themen wie Zeichen und Linien zu verbessern.
		S&W	TZur Ausgabe eines schwarz-weißen Kamerabildes. Diese Funktion kann die Darstellung verbessern, wenn Sie z. B. mit schwarz-weißen Dokumenten arbeiten.
		Negativ	Zur Ausgabe eines negativen Kamerabildes.
		Skizze	Zur Ausgabe eines skizze Kamerabildes.
Den Weißabgleich ein		Automatisch	Der Benutzer hat eine Auswahl an unterschiedlichen Modi (Automatisch, Neonlicht, Kunstlicht und Anpassen), passend zu den verschiedenartigen Umgebungen.
		Neonlicht	
		Kunstlicht	
		Anpassen	
Schnellvergrößerung		2X / 4X	Zur schnellen Auswahl der Vergrößerungsstufen 2X / 4X.
Fokus		Normal	Standardmodus bei Entfernungen von 30 cm bis unendlich.
		Makro/ Mikroskop	Den Makro/Mikroskop-Modus wählen Sie bei Nahaufnahmen und beim Anschluss eines Mikroskopes.
Standbildauflösung		0.8M / 2M 5M / 8M	Wählen Sie die gewünschte Standbildauflösung.
Video-Modus		Hohe Qualität	Wählen Sie den gewünschten Videomodus
		Hohe Bildw. Frequenz	

Element	Symbol	Option	Beschreibung	
Einstellung	Signalton		Ein / Aus	Schaltet Tonsignale ein und aus
	Netzfrequenz		50Hz / 60Hz	Stellt die Funktion zur Beseitigung flimmernder Darstellung auf 50 oder 60 Hz ein. Diese Einstellung richtet sich nach der Frequenz Ihrer Netzspannung.
	USB Verbindung		Off	Trennen Sie das USB-Funktion aus
			Datenträger	Zur Auswahl des Massenspeichermodus wählen Sie „Datenträger“
			PC-Kamera	Die Einstellung „PC-Kamera“ schaltet zum PCKameramodus um
	HDMI Ausgang		720p	Einstellung der HD-Ausgang Auflösung
			1080i	
	VGA-Ausgang		XGA	Einstellung der VGA-Ausgang Auflösung
			UXGA	
	Uhr		-	Zum Einstellen von Datum und Uhrzeit
	Sprache		-	Zur Auswahl der Sprache, in der das OSD (Bildschirmenü) angezeigt wird
	Formatieren		Nein / Ja	Zum Formatieren von Speichermedien. Bitte beachten Sie, dass der Datenträger dabei komplett gelöscht wird.
Werkseinstellungen		Nein / Ja	Stellt die Werksvorgaben wieder her. Bitte beachten Sie, dass die aktuellen Einstellungen dabei überschrieben werden.	
Exit		-	Exit Menu.	

● Menüoptionen bei der Wiedergabe

Element	Symbol	Option	Beschreibung
Eins löschen		Nein / Ja	Löscht die aktuelle Datei.
Alles löschen		Nein / Ja	Löscht sämtliche Dateien desselben Typs aus dem Speicher.
Diaschau		Ein / Aus	Diaschau
Dateiinfo		-	Zeigt den Dateinamen, Datum und Uhrzeit der letzten Änderung, Dateigröße und die Länge der Aufzeichnung an.
Lautstärke		-	Anpassen der Lautstärke bei Videowiedergabe.
Kamera		-	Wiedergabemodus verlassen und zurück zum Vorschaumodus.

● Videos aufzeichnen / Standbild aufnehmen

1. Stellen Sie die Bildaufnahme oder die Videoauflösung entsprechend der nachstehenden Tabelle ein:

Ausgabe-Umschalter	Auflösung Einstellung	Bildaufnahme Auflösung	Videoaufnahme Auflösung
VGA	XGA	1024 x 768	1024 x 768
	UXGA	1600 x 1200	
HDMI	720P	1280 x 720	1280 x 720
	1080i	1920 x 1080	1920 x 1080

2. Im Fokusmodus „Normal “ werden Objekte im Abstand von 30 cm bis unendlich scharf dargestellt.

Im Fokusmodus „Makro “ (🌸) / (🐛) werden Objekte im Abstand von 8 – 30 cm scharf abgebildet.



3. Mit der Zoomfunktion (🔍 / 🔍) vergrößern und verkleinern Sie die Darstellung.

4. Autofokus/Manueller Fokus

Mit der Autofokustaste (📷) stellen Sie das Bild automatisch scharf. Diese Funktion wird bei jedem Objekt erneut ausgelöst. Mit der Taste zum manuellen Fokussieren (📷 / 📷) (können Sie die Bildscharfe fein abstimmen).

5. Mit der Aufzeichnungstaste (📹) starten Sie eine Aufnahme; die Aufnahme stoppt, wenn sie die Taste erneut betätigen. Drücken Sie die Snap-Taste (📷) um ein Foto aufzunehmen.

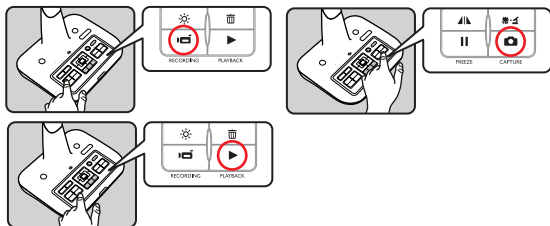

● Wiedergabe

1. Drücken Sie die Wiedergabetaste (▶) .
2. Das zuletzt aufgenommene Bild oder Video wird abgespielt.
3. Mit den Aufwärts-/Abwärtstasten schalten Sie zwischen den einzelnen Dateien um.

● Dateien zum Computer kopieren

Bitte beachten Sie, dass Videos im AVI-Format aufgezeichnet werden und unter der Bezeichnung „Videoxxx.avi“ gespeichert werden („xxx“ steht dabei für die laufende Nummer, z. B. „Video1234.avi“).

Bevor Sie solche Videos am PC betrachten können, müssen Sie eventuell spezielle Software zur Medienwiedergabe installieren.

1. Schalten Sie das Gerät ein.
2. Verbinden Sie das Gerät über ein USB-Kabel mit dem Computer.
3. Drücken Sie die MENU-Taste ($\frac{\text{MENU}}{\text{OK}}$), wählen Sie „USB-Verbindung“, anschließend „Datenträger“. Nun können Sie entweder auf den internen Speicher oder ein externes Speichermedium zugreifen.

Anschließend können Sie gespeicherte Dateien mit der Bildbetrachtungssoftware Ihres PCs darstellen oder die Dateien wie gewohnt zum PC übertragen.

⚠ Verbinden und trennen Sie das USB-Kabel nicht, während Sie gerade Tasten am Bedienfeld oder an der Fernbedienung betätigen – dies kann Fehlfunktionen verursachen.

● Gerät als PC-Kamera verwenden

Anwendung starten

1. Gerät mit dem Computer verbinden.
Schalten Sie den Computer ein, warten Sie, bis das Betriebssystem vollständig geladen ist. Verbinden Sie das USB-Kabel mit dem USB-Port Ihres Computers. Achten Sie darauf, den Stecker richtig herum einzustecken.

Zum PC-Kameramodus umschalten.

Schließen Sie das andere Ende des USB-Kabels an das Gerät an. Schalten Sie das Gerät ein, drücken Sie die MENU-Taste ($\frac{\text{MENU}}{\text{OK}}$), wählen Sie „USB-Verbindung“, „PC-Kamera“ () anschließend drücken Sie die OK-Taste zur Bestätigung.

2. PC-Kamera starten

Nachdem das Gerät richtig angeschlossen und vom PC erkannt wurde, können Sie Ihre bevorzugte Software starten und mit der PC-Kamera nutzen.

Handhabung der Smart DC Software

1. Stellen Sie sicher, dass die USB Verbindung auf „PC-Cam“ steht.
2. Verbinden Sie die Kamera mit dem PC mit dem mitgeliefertem USB Kabel.
3. Starten Sie die Smart DC Software auf Ihrem Computer.

Erweiterte Funktionen

● Hervorhebungsfunktion/ Maskierungsfunktion

Hervorhebungsfunktion

1. Wenn Sie die Aufmerksamkeit Ihres Publikums auf einen bestimmten Teil des Bildes lenken möchten, bietet sich die Hervorhebungsfunktion an.
2. Drücken Sie die Hervorhebungstaste () an der Fernbedienung, bewegen Sie den Hervorhebungsbereich mit den Richtungstasten.

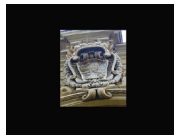

Maskierungsfunktion

1. Sie können bestimmte Teile des Bildes maskieren, also ausblenden.
2. Drücken Sie die Maskierungstaste () an der Fernbedienung, bewegen Sie den Maskierungsbereich mit den Richtungstasten.

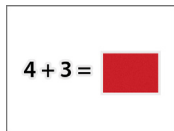

! Drücken Sie die Größe-Taste () an der Fernbedienung, wenn Sie die Größe des hervorgehobenen oder maskierten Bereiches ändern möchten: Benutzen Sie dazu die Richtungstasten.

! Wenn Sie die Farbe des hervorgehobenen oder maskierten Bereiches ändern möchten, drücken Sie die Farbe-Taste () an der Fernbedienung und stellen die gewünschte Farbe mit den Richtungstasten ein.

● BiB-Funktion (Bild-im-Bild)

1. Mit der BiB-Taste () können Sie ein Standbild (ein Viertel der Bildgröße) in das Kamerabild einblenden.
2. Mit den Aufwärts-/Abwärtstasten verschieben Sie das Standbild nach oben oder unten links.

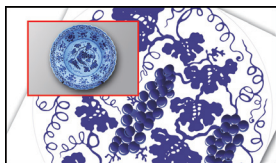

● Mikroskop anschließen

Über ein angeschlossenes Mikroskop können Sie Objekte bei großer Darstellung untersuchen.

1. Wählen Sie ein passendes Mikroskop und entsprechende Objekte.
2. Wählen Sie einen passenden Mikroskopadapter.
3. Mikroskopadapter sind für folgende Okulare erhältlich: 28 mm, 31 mm, 33 mm, 34 mm Durchmesser.

❗ Bei Okularen mit \varnothing 33 und \varnothing 34 mm Durchmesser sollte nur ein mit \varnothing 33 oder \varnothing 34 mm Durchmesser gekennzeichneter Mikroskopadapter installiert werden.

❗ Bei Okularen mit \varnothing 28 mm Durchmesser setzen Sie bitte den \varnothing 28 mm-Adapter in die \varnothing 33- oder \varnothing 34 mm-Aufnahme ein.

❗ Bei Okularen mit \varnothing 31 mm Durchmesser setzen Sie bitte den \varnothing 31 mm-Adapter in die \varnothing 33- oder \varnothing 34 mm-Aufnahme ein.

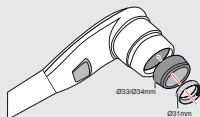
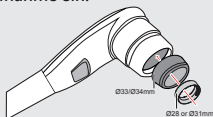
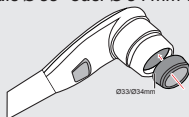

4. Bringen Sie den Mikroskopadapter am Objektiv an.

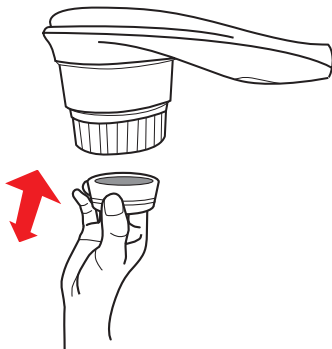



5. Switch the focus mode to Macro.
Schalten Sie den Focus-Modus auf Macro um.
Drücken Sie die MENU-Taste - wählen Sie
Focus() -->

select Macro oder drücken Sie die Makrotaste(
) an der Fernbedienung

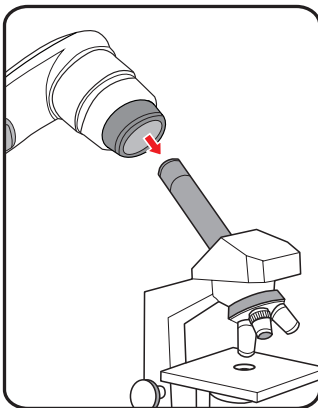

6. Verbinden Sie das Objektiv mit angebrachtem
Mikroskopadapter mit dem Mikroskop



- ❗ Stellen Sie das Bild über die Bedienelemente des Mikroskops scharf.
- ❗ Zur Feinabstimmung des Bildes drücken Sie die Autofokus-Taste () oder nutzen die Fernbedienungstasten zur manuellen Focussierung.

Lagern

1. Schalten Sie das Gerät aus.

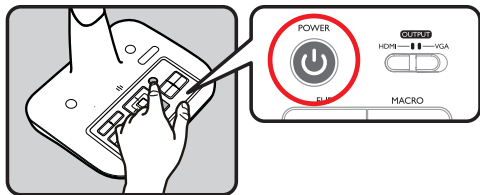

2. Ziehen Sie den Netzstecker des Netzteils aus der Steckdose. Trennen Sie nun das Netzteil und sämtliche Kabel vom Gerät.

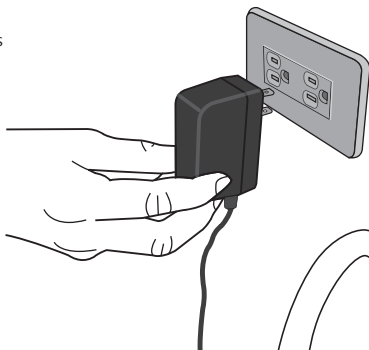

3. Klappen Sie Kamerakopf und Arm wie in der Abbildung gezeigt zusammen.

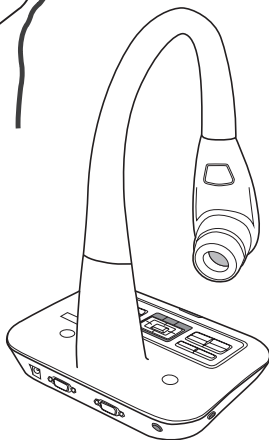

Problemlösung

Beim Einsatz der Dokumentenkamera :		
Problem	Ursache	Lösung
Das Gerät lässt sich nicht einschalten.	Das Netzteil wurde nicht richtig an die Steckdose oder an die Dokumentenkamera angeschlossen.	Schließen Sie das Netzteil wieder richtig an die Dokumentenkamera und an die Steckdose an.
Bilder und Videos lassen sich nicht aufzeichnen	Der Speicher ist voll.	Schaffen Sie etwas Platz auf der Speicherkarte oder im internen Speicher.
	Die Speicherkarte ist schreibgeschützt.	Setzen Sie den Schreibschutz der Speicherkarte außer Kraft.
Nach dem Anschluss erscheint kein Bild.	Die Dokumentenkamera ist nicht richtig mit externen Geräten verbunden.	Schließen Sie sämtliche Kabel zu externen Geräten richtig an.
	Am Ausgabegerät wurde der falsche Eingang eingestellt.	Stellen Sie den richtigen Eingang am Ausgabegerät ein.
	Am Ausgabegerät wurde eine falsche Auflösung eingestellt.	Stellen Sie eine unterstützte Auflösung am Ausgabegerät ein.
	An der Dokumentenkamera wurde ein falscher Ausgang gewählt.	Stellen Sie den richtigen Ausgang ein.
	Der Indikator der PC Durchschleiffunktion leuchtet.	Schalten Sie diese Funktion über die jeweilige Taste [] ab.

Beim Einsatz der Dokumentenkamera :		
Problem	Ursache	Lösung
Das Bild ist verschwommen	Das Objekt befindet sich vermutlich zu nahe am Objektiv.	Stellen Sie die Schärfe mit der Autofokustaste ein oder manuell nach.
		Wählen Sie den Makromodus, wenn sich das Objekt weniger als 30cm entfernt befindet.
Das Bild ist umgedreht.	Das Objekt wurde nicht richtig in den empfohlenen Arbeitsbereich gelegt.	Drehen Sie das Bild mit der [] Taste um.
Das Bild bewegt sich nicht.	Das Kamerabild wird als Standbild angezeigt [III].	Drücken Sie zum Abschalten der Standbilddarstellung die [III] Taste am Bedienfeld.
Die Fernbedienung funktioniert nicht.	Die Batterien sind erschöpft.	Legen Sie neue AAA-Batterien in die Fernbedienung ein.
	Ein Hindernis befindet sich zwischen Fernbedienung und Fernbedienungssensor.	Entfernen Sie das Hindernis.
	Der Abstand zwischen Fernbedienung und Fernbedienungssensor ist zu groß.	Verkleinern Sie den Abstand.
Im LC-Display wird „Speicherfehler “ oder „Kartenfehler “ angezeigt – oder die Speicherkarte kann nicht gelesen werden.	Die Formatierung der Speicherkarte ist nicht mit der Dokumentenkamera kompatibel.	Formatieren Sie die Speicherkarte mit der „Formatieren “-Funktion der Dokumentenkamera erneut.
	Die Speicherkarte ist defekt.	Legen Sie eine andere Speicherkarte ein.

Beim Einsatz der Dokumentenkamera:		
Problem	Ursache	Lösung
Bilder und Videos lassen sich nicht löschen und auch nicht auf der Speicherkarte finden.	Die unauffindbaren Aufzeichnungen wurden im internen Speicher abgelegt.	Dies geschieht, wenn Sie ein paar Bilder oder Videos aufzeichnen und dann erst eine Speicherkarte einlegen. Nachdem Sie die Speicherkarte herausgenommen haben, können Sie wieder auf solche Dateien zugreifen.
Videos lassen sich nicht am Computer wiedergeben.	Ihr Computer muss mit einer passenden Software ausgestattet sein.	Installieren Sie Direct X 9.0c (oder aktueller) und die Windows Media 9.0-Codecs zur Lösung dieses Problems. Die dazu benötigten Dateien können Sie unter http://www.microsoft.com herunterladen. Bitte lesen Sie unter „Dateien zum Computer kopieren“ nach.
Nach dem Anschluss an ein Fernsehgerät erscheint kein Bild.	Das Gerät wurde nicht richtig mit dem Fernsehgerät verbunden.	Schließen Sie das Gerät richtig an das Fernsehgerät an.
Bei der Bildanzeige über das interne LC-Display oder am Computer treten Bildstörungen auf.	Die Netzfrequenz-Einstellung stimmt nicht mit der Netzfrequenz Ihres Stromnetzes überein.	Stellen Sie die Netzfrequenz entsprechend ein. Weitere Hinweise finden Sie in der Tabelle „Frequenzeinstellungen“.

⚠ Die Inhalte dieser Anleitung können sich ohne Vorankündigung ändern.

DC450

Manual de usuario

Cámara
de
documentos

Française

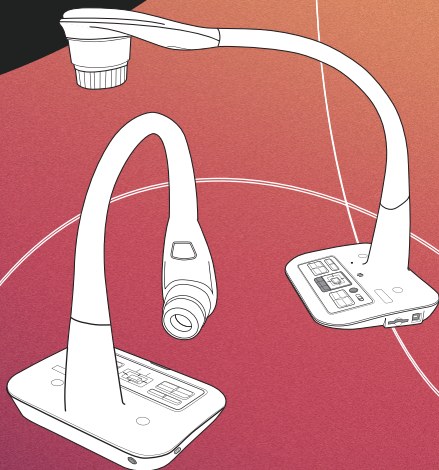

- **Bienvenue:**

Merci d' avoir acheté cet appareil. Veuillez lire attentivement ces instructions avant d' utiliser cet appareil.

- **Déclaration de conformité à la réglementation de la FCC(Classe A):**

Cet appareil est conforme à la section 15 de la réglementation de la FCC. Son utilisation est soumise aux deux conditions suivantes : (1) cet appareil ne doit pas provoquer d' interférences nuisibles et (2) cet appareil doit tolérer les interférences reçues, y compris celles qui sont susceptibles de perturber son fonctionnement.



- **Déclaration de la Commission Fédérale des Télécommunications (FCC):**

Cet appareil produit, utilise et peut émettre une énergie haute fréquence et provoquer des interférences nuisibles pour les communications radio s' il n' est pas installé et utilisé conformément aux instructions. L' utilisation de cet appareil dans un environnement domestique peut provoquer des interférences nuisibles pour les communications radio et, le cas échéant, l' utilisateur est responsable de prendre des mesures adéquates pour éliminer ces interférences.

- **Déclaration de conformité à la Communauté Européenne (Classe A):**

Cet appareil est un produit de Classe A. Dans un environnement domestique, cet appareil peut provoquer des interférences nuisibles pour les communications radio et, le cas échéant, l' utilisateur est responsable de prendre des mesures adéquates pour éliminer ces interférences.



Le symbole de la poubelle à roulettes barrée indique que cet appareil ne doit pas être jeté avec les ordures municipales. Vous devez vous débarrasser de cet appareil, lorsque vous n' en avez plus besoin, en l' emmenant dans un point de collection spécialement conçu pour le recyclage des appareils électriques et électroniques.



Avertissement

1. Ne regardez jamais directement la source d' éclairage DEL, car elle peut faire mal à la rétine.

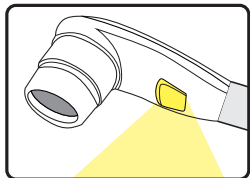

2. Lorsque vous voulez transporter l' appareil, tenez directement la partie inférieure de l' unité principale avec les deux mains. Ne transportez jamais l' appareil en utilisant le bras ou la tête de la caméra.

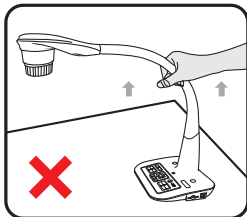
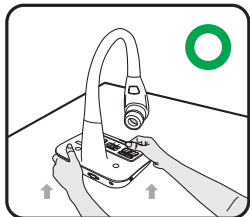

3. Faites attention à ne pas cogner la tête de la caméra sur un bureau ou tout objet dur.
4. Ne tournez jamais le bras dans la direction opposée.
5. Assurez-vous de garder une main sur la base de l'appareil lors de l'ajustement du bras et de la tête de la caméra.

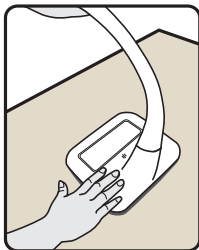

Préparation du visualiseur

● Présentation des parties

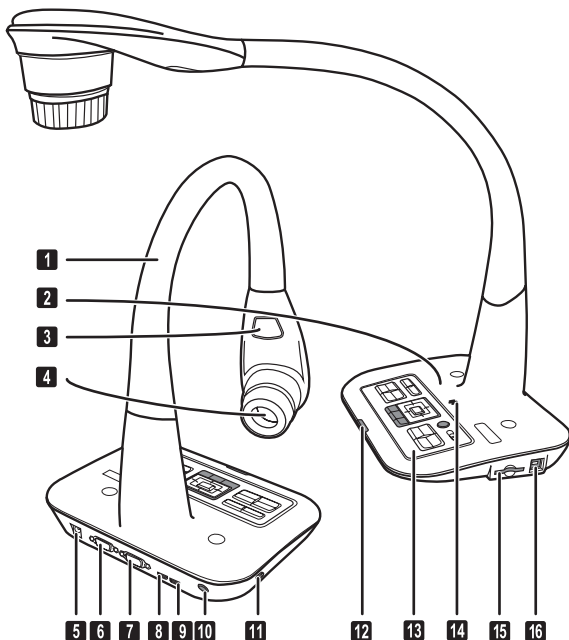

- | | |
|--------------------------|--|
| 1 Bras col de cygne | 9 Entrée HDMI |
| 2 Microphone | 10 Récepteur de signal de télécommande |
| 3 Lampe LED | 11 Emplacement antiviol |
| 4 Tête de caméra | 12 Récepteur de signal de télécommande |
| 5 Prise électrique 5V CC | 13 Panneau de commande |
| 6 Port de sortie VGA | 14 Orateur |
| 7 Port d'entrée VGA | 15 Emplacement carte SD |
| 8 Sortie HDMI | 16 Port USB |

● Panneau de configuration

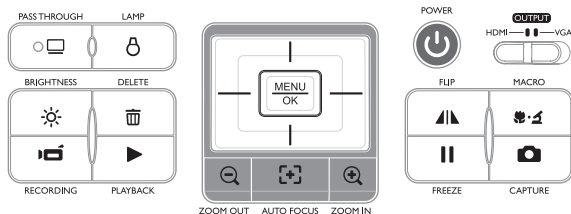

Bouton	Fonction	Bouton	Fonction
	Allumer/éteindre l' alimentation		Zoom arrière
	Tourner l' image par 180° chaque fois		Zoom avant
	Interrupteur Macro/Normal		Mise au point automatique unique
	Geler l' image affichée		Accès au mode PC pour exécuter la fonction « PASSAGE »
	Prendre une photo		Allumer/éteindre et régler la luminosité de la lampe LED
	Affichage du menu et sélection		Activer la touche de raccourci de la luminosité
	Bouton de direction		Suppression des fichiers de la mémoire en mode lecture
	Interrupteur de sortie HDMI-VGA		Enregistrement d' une séquence vidéo et audio
			Accès au mode Lecture pour visualiser les séquences vidéo et les images enregistrées

● Télécommande

Bouton	Fonction
	Activer la touche de raccourci de la luminosité
	Allumer/éteindre l' alimentation
	Geler l' image affichée
ICON	Afficher ou cacher les icônes de l' écran
	Pour ouvrir ou fermer le menu OSD
	Ouvrir le mode Lecture pour afficher les photos et les clips vidéos qui ont été enregistrés
	Tourner l' image par 180° chaque fois
	Utilisez ces boutons pour sélectionner et ajuster
	Enregistrer un clip vidéo
	Prendre une photo
	Zoom arrière / Zoom avant sur l' image
	Une photo avec mise au point automatique
	Utilisez la barre de niveau pour ajuster manuellement la mise au point
	Aller rapidement au zoom numérique 2X ou 4X
	Activer/désactiver la fonction Surbrillance
	Activer/désactiver la fonction Cacher
	Interrupteur Macro/Normal
	Ajustez la taille de la partie en surbrillance/cachée avec les touches de navigation
	Réglez la couleur de l' extérieur de la partie en surbrillance/cachée avec les touches de navigation

Bouton	Fonction
	Augmenter/baisser le volume
	Activer/désactiver la fonction Image dans image *Pour afficher une image fixe sous forme d' une petite image tout en affichant l' image

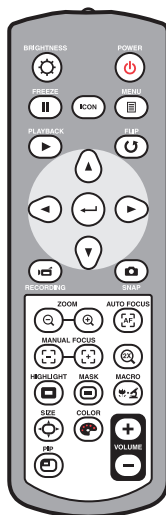

- ❗ La télécommande infrarouge ne peut être utilisée que près de l' appareil.
- ❗ Insérez les piles dans le bon sens en respectant les signes "+" et "-" .
- ❗ Enlevez les deux piles AAA en même temps. N' utilisez pas une pile neuve avec une pile usée ou des piles différentes.

Installation

Cette section explique comment faire pour installer et ajuster le visualiseur en fonction de vos besoins.

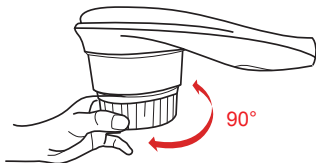

● Rotation

Tourner pour une rotation 90° de l' image



● Lampe d' éclairage

Si vous êtes dans un environnement sombre, allumez la lampe DEL pour une meilleure exposition.

1. Appuyez sur le bouton de la lampe DEL () à la base pour allumer/éteindre la lampe DEL.
2. Ajustez la luminosité en appuyant sur le bouton de la lampe ().

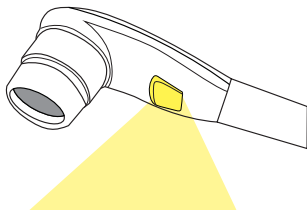

● Interrupteur de sortie

Adaptez l' interrupteur de sortie en fonction de la sortie branchée.

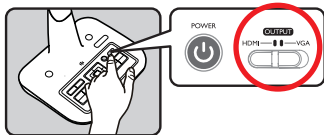

● Bras col de cygne

Le bras col de cygne peut être ajusté pour s' adapter à différents espaces de travail.

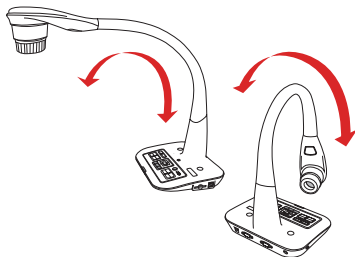

● Espace de travail recommandé

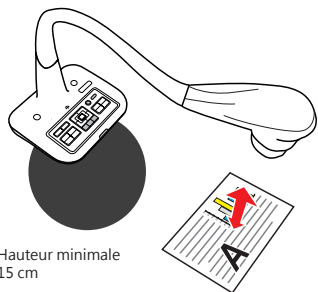
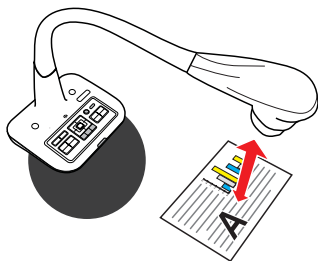
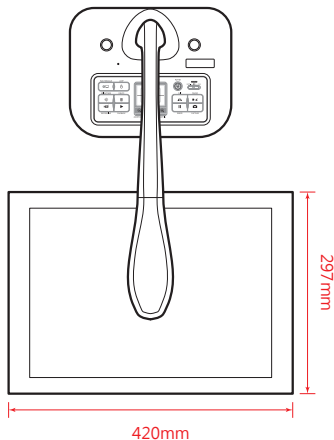

- ❗ Si le document n'est pas mis dans l'espace de travail recommandé, l'image doit être tournée avec le bouton RETOURNER (↻) du panneau de contrôle ou de la télécommande.

● Réglage de la luminosité

1. Appuyez sur le bouton LUMINOSITÉ de la télécommande (☀️/⚙️).
2. Utilisez les boutons (◀️/▶️) pour augmenter ou réduire le niveau de luminosité.

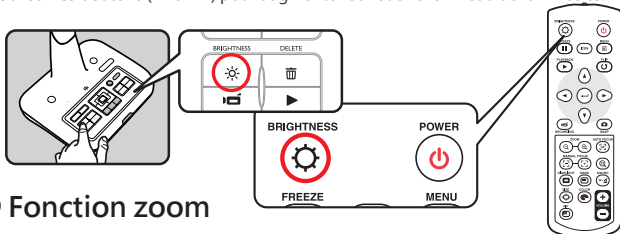

● Fonction zoom

Utilisez le bouton Zoom (🔍/🔍) pour faire un zoom avant ou arrière à l' écran.

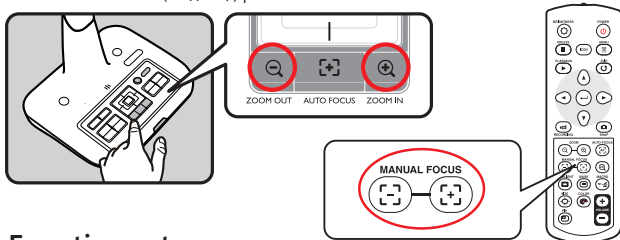

● Fonction retourner

Appuyer sur le bouton pour retourner l' image (↶/↷).

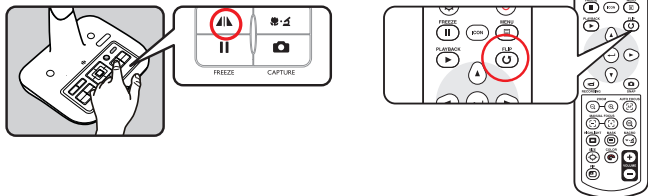

● Régler la taille focus

► Automatique focus

Appuyez sur le bouton AF ($\left[\text{AF} \right]$) à automatique focus. Cette fonction fournit une auto one-shot-focus.

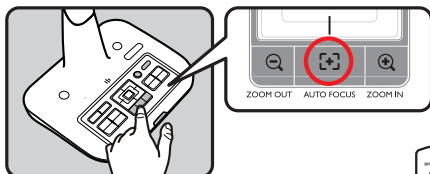

► Manual Focus

Appuyez sur le bouton manual focus ($\left[- \right]$ / $\left[+ \right]$) sur la télécommande pour affiner la mise au point.



● Anti-reflêt

La feuille anti-reflêt est une feuille transparente en plastique qui se pose au-dessus des objets ou des surfaces brillantes pour réduire les reflêts. Pour l'utiliser, posez la feuille anti-reflêt au-dessus d'un objet ou d'une surface brillante, comme un magazine, pour réduire les reflêts de la lumière.

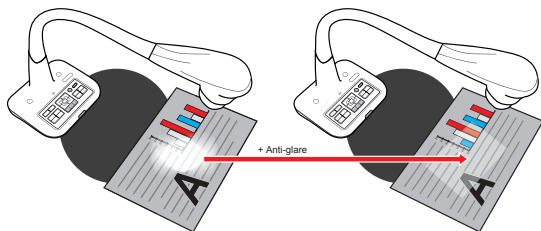

● Ajuster la balance des blancs

1. Le paramètre de balance des blancs du document est sur «Auto» par défaut.
2. L' utilisateur peut choisir entre de nombreux modes (Auto, Fluorescent, Tungstène et Personnalisé) pour s' adapter à différents environnements.
3. Balance des blancs personnalisée:

Appuyez sur le bouton «MENU» ($\frac{\text{MENU}}{\text{OK}}$) → Balances des blancs → essayez le mode «Personnalisé».

Une fenêtre s' affichera comme sur l' illustration ci-dessous:

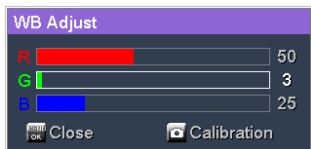

Appuyez sur le bouton CAPTURE () pour obtenir les données de l' image actuelle

Utilisez les «Touches directionnelles» () pour ajuster les valeurs R, G et B.

Appuyez sur le bouton «OK» ($\frac{\text{MENU}}{\text{OK}}$) pour valider les réglages et fermer la fenêtre.

● Insérer et retirer une carte SD/SDHC (pas fourni)

1. Insérez la carte mémoire dans la fente avec l' étiquette en haut et jusqu' au fond.
2. Si vous avez correctement inséré la carte, l' icône() apparaîtra sur l' écran et la mémoire interne ne sera plus disponible.
3. Pour retirer la carte, poussez-la pour la libérer, puis tirez-la doucement hors de la fente.

- ❗ N' éteignez pas l' alimentation lorsque vous formatez la carte SD.
- ❗ Utilisez cet appareil pour formater la carte SD. Si vous avez déjà formaté la carte SD avec un ordinateur, formatez-la à nouveau en utilisant l' appareil.
- ❗ Si aucun périphérique de stockage n' est connecté, les fichiers seront tous enregistrés dans la mémoire interne.

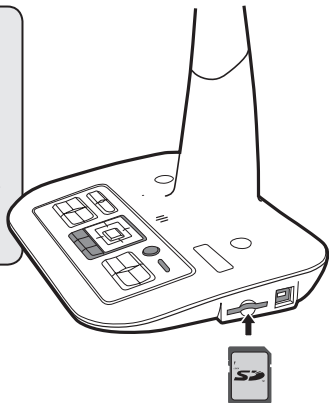

Branchement des connexions

● Diagramme du système

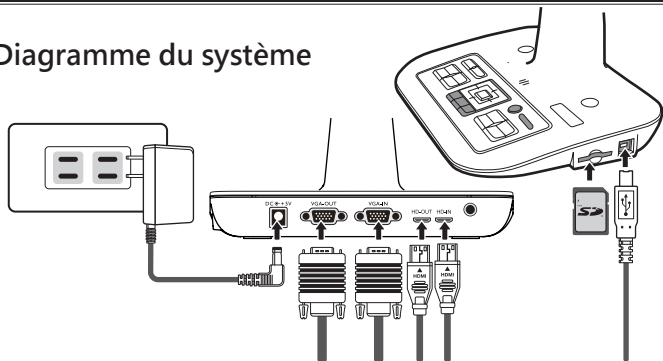

Etape 1 / Branchement sur une prise de courant

Utilisez l'adaptateur secteur pour brancher la prise ENTREE CC de l'appareil sur une prise de courant 100—240V CA.

❗ Le type d' adaptateur d' alimentation est en fonction de / vos régions du pays.

















Etape 2/Résolution de sortie et rapport d' aspect

Plusieurs résolutions de sortie sont disponibles en fonction des réglages de la sortie et du rapport d'aspect. Voir tableau ci-dessous:

Sortie	Rapport d' aspect	Résolution	Fréquence verticale
VGA	4:3	1024 x 768	50 / 60 Hz
		1600 x 1200	
HDMI	16:9	1280 x 720	50 / 60 Hz
		1920 x 1080	

*Le visualiseur réduit automatiquement la résolution de sortie si l'appareil d'affichage ne supporte pas la résolution maximale.

Etape 2/Résolution d' affichage et rapport d' aspect

	Port du produit	Cable	port dispositif d'affichage	PC Port
VGA	 RGB OUTPUT		 RGB INPUT	
	 RGB INPUT			 RGB OUTPUT
HDMI	 Mini HD OUT		 HDMI-INPUT	
	 Mini HD IN			 HDMI-OUTPUT
USB	 TYPE B Port		 TYPE A Port	 TYPE A Port

► Télévision et projecteur standard

• Raccordement par la SORTIE VGA

Raccordez un câble VGA au port de sortie VGA.

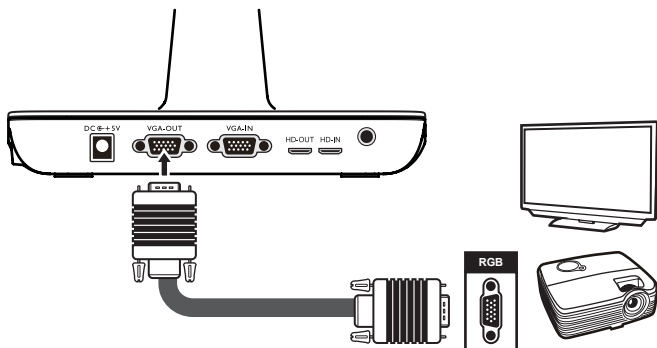

● Raccordement à un ordinateur

► Fonction passage

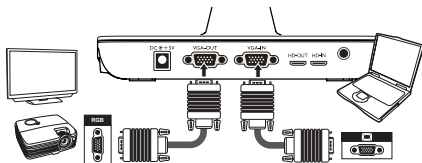

Utilisez le câble VGA pour raccorder la prise d'entrée VGA du visualiseur de documents à la prise de sortie VGA de l'ordinateur

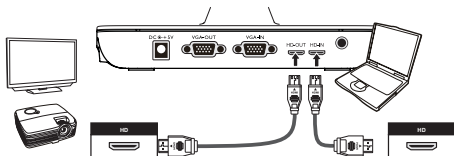

► Passthrough via câble HDMI

Branchement de l'entrée HD du visualiseur à la sortie HD de l'ordinateur via câble HDMI.



- ❗ Pour afficher l'image de l'ordinateur, appuyez sur le bouton PC () du panneau de contrôle.
- ❗ Sur un ordinateur portable, pour sélectionner le mode de sortie d'affichage, utilisez la commande clavier (Fn + ) pour changer entre les modes d'affichage. Pour les autres commandes, référez-vous au manuel de votre ordinateur portable.
- ❗ Le signal entre le port ENTRÉE VGA et SORTIE VGA est seulement Passthrough sur le visualiseur.

► Raccordement par USB

Appuyez sur le bouton MENU () → Connexion USB.

Sélectionnez « Disque » pour raccorder un stockage de masse.















Sélectionnez « PC Cam » pour l'utiliser comme une webcam.



















Utilisation basique







1. Appuyez sur le bouton MENU ()($\frac{\text{MENU}}{\text{OK}}$) sur la télécommande ou le panneau de contrôle.
2. Appuyez sur les boutons (◀ or ▶) pour changer entre les onglets.
3. Appuyez sur(←)($\frac{\text{MENU}}{\text{OK}}$) tpour sélectionner et afficher les réglages disponibles.
4. Utilisez (◀ or ▶) pour ajuster un réglage.
5. Appuyez sur (←) ($\frac{\text{MENU}}{\text{OK}}$) pour confirmer un nouveau réglage.
6. Appuyez à nouveau sur le bouton MENU pour fermer le menu OSD.

● Options du menu dans le mode Prévisualisation

Elément	icon	Option	Description
Luminosité		-	Utilisez les boutons Droite/Gauche pour rendre l' image plus claire/foncée
Effet		Graphique	Choisir le graphic, vous pouvez avoir des documents en couleur plus claires, plus évidents, comme par exemple : Graphique 2 photos ou des schemats.
		Texte	Ces fonctions étaient créées et fournies seulement pour des document Sen textes ou des documents en noir et blanc, par exemple des caractères ou des traits en noir.
		N & B	Pour prendre une image en noir & blanc avec la caméra. Pour mieux voir l' image, sélectionnez cela lorsque vous prenez des photos de documents en noir & blanc, etc.
		Négatif	Pour prendre une image négatif avec la caméra.
		Croquis	Pour prendre une image croquis avec la caméra.
Balance des blancs		Auto	L' utilisateur peut choisir entre de nombreux modes (Auto, Fluorescent, Tungstène et personnalisé) pour s' adapter à différents environnements.
		Fluorescent	
		Tungstène	
		Personnalisé	
Zoom rapide		2X / 4X	Réglez le zoom rapide sur 2X ou 4X.
Mise au point		Normal	Sélectionnez le mode Standard pour 37cm ~ ∞.
		Macro / Microscope	Sélectionnez le mode Macro/Microscope pour prendre des photos en gros plan ou lorsque connecté à un microscope.
Résolution fixe		0,8M / 2M 5M / 8M	Sélectionnez la résolution fixe désirée.

Elément	icon	Option	Description	
Mode vidéo		Haut e qualité	Sélectionnez le mode vidéo désiré	
		rafraichissement élevé		
RÉGLAGE	Bip		Marche/Arrêt	Pour activer/désactiver le son bip
	Fréquence		50Hz / 60Hz	Pour régler la fréquence de scintillement sur 50Hz ou 60Hz. Le réglage de fréquence est basé sur le standard de fréquence de votre réseau électrique local.
	Connexion USB		Non / Oui	Débranchez la fonction USB
			Disque	Sélectionnez « Disque » pour le mode Stockage de masse »
			Cam PC	Sélectionnez « Cam PC » pour ouvrir le mode Cam PC
	Sortie HDMI		720p	Ajuster la résolution de sortie HD
			1080i	
	Sortie VGA		XGA	Ajuster la résolution de sortie VGA
			UXGA	
	Horloge		-	Pour régler la date et l' heure
	Langue		-	Permet de choisir la langue utilisée par l' OSD
	Formater		Non / Oui	Pour formater le support de stockage. Notez que tous les fichiers stockés sur le support sont supprimés.
Réinitialisation défaut		Non / Oui	Pour restaurer les réglages d' usine par défaut. Notez que vos réglages actuels sont effacés.	
Quitter		-	Quitter	

● Menu options in Playback Mode

Elément	icon	Option	Description
Eins löschen		Non / Oui	Pour supprimer le fichier sélectionné.
Alles löschen		Non / Oui	Pour supprimer toutes les images du même type enregistrées dans la mémoire.
Diaschau		Marche/Arrêt	Pour faire un diaporama avec l' intervalle sélectionné
Dateiinfo		-	Pour afficher le titre du fichier, la date et l' heure enregistré, la taille et la longueur de l' enregistrement.
Volume		-	Régler le volume de la lecture vidéo.
Caméra		-	Quitter le mode lecture et retourner dans le mode de prévisualisation.

● Enregistrer un clip vidéo / Prendre une photo



1. Adapter la résolution de capture ou d' enregistrement aux réglages, voir tableau ci-dessous:



Interrupteur de sortie	Réglage de la résolution	Résolution de capture	Résolution d' enregistrement
VGA	XGA	1024 x 768	1024 x 768
	UXGA	1600 x 1200	
HDMI	720P	1280 x 720	1280 x 720
	1080i	1920 x 1080	1920 x 1080

2. Choisissez le mode de mise au point approprié en fonction de la distance de l' objet désiré: Réglez le mode de mise au point sur Normal pour entre 37cm et ∞. Changez le mode de mise au point sur Macro () pour entre 6cm ~ 37cm.

3. Utilisez les boutons ( / ) de zoom pour faire un zoom avant ou arrière sur l' écran.



4. Appuyez sur le bouton [AF] () pour faire une mise au point automatique. Cette fonction permet de prendre une photo avec mise au point automatique. Utilisez le bouton de mise au point manuelle ( / ) de la télécommande pour ajuster manuellement la mise au point.

5. Appuyez sur le bouton Enregistrer () pour commencer un enregistrement et appuyez à nouveau pour arrêter l' enregistrement. Appuyez sur le bouton pression () pour prendre une image fixe.



● Lecture

1. Appuyez sur le bouton LECTURE ().
2. La dernière image ou clip vidéo enregistré commencera.
3. Use Up / Down button to choose files.



● Copier des fichiers sur votre ordinateur

Veillez noter que les clips vidéo sont enregistrés au format AVI et qu'ils sont compilés avec CLIPxxxx.avi(xxxx sont des numéros en série). Avant de pouvoir regarder ces clips vidéo sur votre PC, il est possible que vous ayez besoin d'installer des programmes multimédia.

1. Allumez l'appareil.
2. Branchez l'appareil sur l'ordinateur en utilisant un câble USB.
3. Appuyez sur MENU ($\frac{\text{MENU}}{\text{OK}}$) → sélectionnez « Connexion USB » → choisissez « Disque ». La mémoire interne ou la mémoire externe sera détectée.

Vous pouvez alors regarder les images d'une carte SD en utilisant un logiciel de lecture sur le PC ou couper et coller simplement les fichiers sur votre PC.

⚠ Lorsque vous utilisez le panneau de contrôle ou la télécommande, ne branchez/débranchez pas le câble USB, car cela peut causer un mal fonctionnement. Ceci peut causer un mal fonctionnement.

● Utilisation de l'appareil comme Cam PC

Démarrage de l'installation

1. Branchez l'appareil sur votre ordinateur.
Allumez votre ordinateur, puis branchez le câble USB accessoire sur le port USB de votre ordinateur. Assurez-vous que le connecteur et le port sont correctement alignés.

Choisissez le mode Cam PC.

Branchez l'autre extrémité du câble USB sur l'appareil.

Allumez, appuyez sur MENU ($\frac{\text{MENU}}{\text{OK}}$) → sélectionnez Connexion USB → sélectionnez Cam PC () et appuyez sur le bouton OK pour confirmer.

2. Lancez la Caméra PC

Une fois l'appareil correctement connecté et détecté par votre PC, Vous pouvez lancer votre logiciel préféré et utiliser la fonction de Caméra PC. et utiliser la fonction de Caméra PC.

Travailler avec Smart DC

1. Vérifiez que le paramètre de connexion USB est sur «PC-Cam».
2. Reliez l'appareil et le PC avec le câble USB.
3. Démarrez Smart DC sur votre PC.

Opérations avancées

● Highlight fonction / Mask fonction

Fonction Surbrillance



1. Si vous voulez attirer l' attention sur une partie particulière d' une image, vous pouvez utiliser la fonction Surbrillance.
2. Appuyez sur le bouton Surbrillance () sur la télécommande et utilisez les boutons de direction pour déplacer la section en surbrillance.

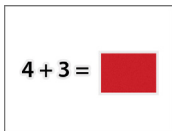

Fonction Cacher

1. Vous pouvez cacher une partie de l' image affichée.
2. Appuyez sur le bouton Cacher () sur la télécommande et utilisez les boutons de direction pour déplacer la section à cacher.



- ❗ Appuyez sur le bouton Taille () sur la télécommande et utilisez les boutons de direction pour ajuster la taille de la section en surbrillance/à cacher.
- ❗ Appuyez sur le bouton Couleur () sur la télécommande et utilisez les boutons de direction pour changer la couleur de la section en surbrillance/à cacher.

● Fonction PIP (Image dans une Image)

1. Appuyez sur le bouton PIP () pour afficher une image fixe d' environ un quart de la taille sur l' affichage en direct de la caméra.
2. Appuyez sur les boutons HAUT / BAS pour modifier la position entre les images.

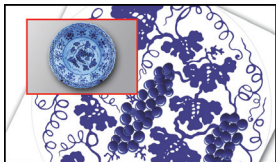

● Branchement d' un microscope

Vous pouvez brancher un microscope pour vous permettre de regarder des objets microscopiques sur un grand écran.

1. Ajustez le microscope et faites la mise au point sur les objets.
2. Choisissez un adaptateur de microscope approprié.
3. Les accessoires d' adaptateur de microphone sont les lentilles suivantes : Ø28mm ,Ø31mm, Ø33mm, Ø34mm.

- ❗ Pour la lentille de Ø33mm, Ø34mm, seulement un adaptateur de microscope avec une étiquette Ø33 ou Ø34mm doit être installé.
- ❗ Pour la lentille de Ø28mm, veuillez insérer l' adaptateur Ø28mm sur le Ø33 ou Ø34mm.
- ❗ Pour la lentille de Ø31mm, veuillez insérer l' adaptateur Ø31mm sur le Ø33 ou Ø34mm.

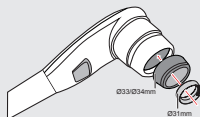
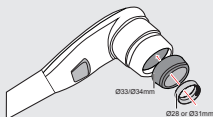
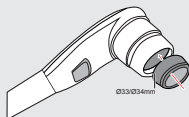

4. Montez / enlevez l' adaptateur du microscope sur / de l' objectif en suivant la manipulation indiquée sur l' image

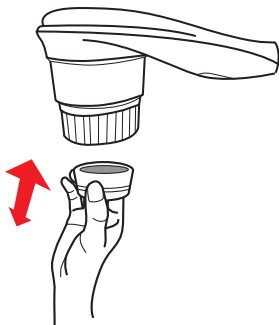

5. Appuyez sur MENU ($\frac{\text{MENU}}{\text{OK}}$)--> sélectionnez Mise au point (⊕) --> sélectionnez Macro ou appuyez sur le bouton ($\text{🌸} \cdot \text{🔬}$) de la télécommande.
6. Branchement de la lentille avec l' adaptateur de microscope sur le microscope.

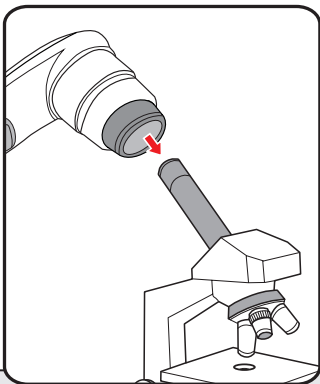

- ❗ Si l' image est floue. Ajustez la mise au point du microscope.
- ❗ Appuyez sur le bouton AF (⊕) ou utilisez le bouton de mise au point manuelle de la télécommande pour ajuster manuellement la point.

Rangement

1. Eteignez l' appareil.

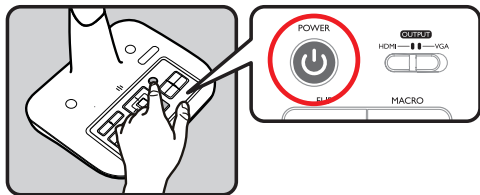

2. Débranchez l' adaptateur secteur de la prise de courant. Puis débranchez l' adaptateur secteur et tous les câbles.

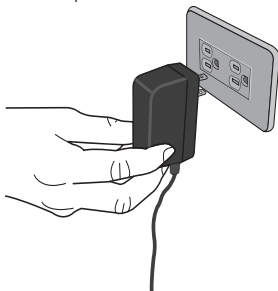

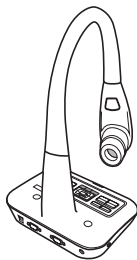

3. Pliez la tête de la caméra et les bras dans les directions indiquées sur la figure.



Résolution de problèmes

Lorsque vous utilisez le visualiseur :		
Problème	Cause	Solution
Elle ne s' allume pas normalement.	L' adaptateur secteur n' est pas branché correctement sur la prise de courant ou sur la caméra de document.	Rebranchez une extrémité de l' adaptateur secteur sur la caméra de document et l' autre extrémité sur une prise de courant.
Impossible de prendre des photos ou d' enregistrer des clips vidéo.	Mémoire insuffisante	Libérez de l' espace sur la carte SD/MMC ou dans la mémoire interne.
	La carte SD que vous utilisez est "protégée"	Réglez la carte SD pour la rendre inscriptible.
Aucune image après la connexion.	La caméra de document n' est pas correctement connectée à l' appareil externe.	Rebranchez tous les câbles appropriés correctement sur l' appareil externe.
	Type de source d' appareil d' affichage externe incorrect.	Réglez le bon type de source de l' appareil d' affichage externe.
	Résolution de l' appareil d' affichage externe incorrecte.	Réglez la résolution supportée de l' appareil d' affichage externe.
	Port de sortie du bouton de sélection de la sortie de la caméra de document incorrect.	Réglez le port de sortie avec le bouton de sélection de la sortie.
	L' indicateur du bouton PC Passthrough est allumé .	[] Appuyez sur le bouton PC Passthrough pour désactiver la fonction.

Lorsque vous utilisez le visualiseur :		
Problème	Cause	Solution
L' image est floue.	La distance entre l' objet et l' objectif est trop petite.	Appuyez sur le bouton AF pour faire automatiquement la mise au point ou ajustez-la en appuyant sur Mise au point manuelle.
		Sélectionnez le mode Macro si la distance est moins de 37cm.
L' image est à l' envers.	Le document n' est pas posé correctement dans l'espace de travail recommandé.	Appuyez sur le bouton [] pour changer la direction.
L' image ne change pas.	L' image de la caméra est réglé sur Geler Freeze [].	Appuyez à nouveau sur le bouton [] du panneau de contrôle pour arrêter la pause.
La télécommande ne marche pas.	Pas d'alimentation	Remplacez les piles AAA de la télécommande.
	Un objet obstrue le récepteur de signal de la télécommande de la caméra de document.	Enlevez les objets qui se trouve devant la caméra de document.
	La distance d'utilisation est trop grande.	Rapprochez-vous de la caméra de document lorsque vous utilisez la télécommande.
L'écran LCD affiche un message « ERREUR MÉMOIRE » ou « ERREUR CARTE ». Ou la carte mémoire ne peut pas être lue	Le format de la carte mémoire n'est pas compatible avec l'appareil.	Utilisez la fonction « FORMATAGE » du visualiseur de documents pour formater la carte.
	La carte mémoire est altérée.	Remplacez la carte mémoire avec une nouvelle carte.

Lorsque vous utilisez le visualiseur :

Problème	Cause	Solution
Impossible de supprimer les images et les séquences vidéo et impossible également de les trouver dans la carte mémoire.	Les enregistrements perdus sont enregistrés dans la mémoire interne.	Ceci se produit quand vous insérez une carte mémoire après avoir pris quelques photos ou séquences vidéo. Vous pourrez accéder à ces fichiers après avoir retiré la carte mémoire.
Impossible de visualiser les séquences vidéo sur mon ordinateur.	Le logiciel n' est pas installé sur l' ordinateur	Installez un logiciel prenant en charge les vidéos au format AVI.
L' écran de la télévision n' affiche rien après avoir raccordé l' appareil à la télévision.	L' appareil n' est pas raccordé correctement à la télévision.	Reconnectez correctement l' appareil à la télévision.
Des bruits apparaissent lors de la visualisation des images sur l' écran LCD ou sur l' ordinateur.	Le réglage du scintillement ne correspond pas à la norme du pays dans lequel vous séjournez.	Ajustez le réglage du scintillement. Pour de plus amples informations, veuillez consulter le tableau « Réglages du scintillement » .

ⓘ Le contenu de ce manuel est sujet à modification sans préavis.

DC450

Manuel utilisateur

Visualiseur

Español

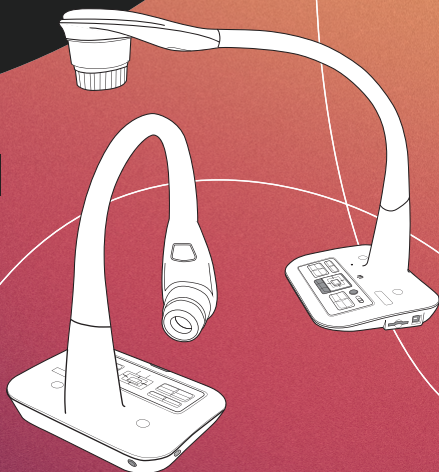

- **Bienvenido:**

Gracias por adquirir este producto. Lea las instrucciones atentamente antes de utilizar el producto.

- **Declaración de cumplimiento de la FCC (clase A):**

Este dispositivo cumple la Parte 15 de las Reglas de la FCC. La operación está sujeta a las siguientes dos condiciones: (1) Este dispositivo no debe causar interferencias perjudiciales y (2) Este dispositivo debe aceptar cualquier interferencia recibida, incluidas aquellas que provoquen un funcionamiento no deseado.



- **Declaración de la Comisión Federal de Comunicaciones :**

Este equipo se ha probado y se ha encontrado que cumple con los límites de un dispositivo digital de Clase A, de acuerdo con el apartado 15 de la Normativa FCC. Estos límites están diseñados para proporcionar una protección razonable contra las interferencias perjudiciales cuando el equipo se utilice en un entorno comercial. Este equipo genera, utiliza y puede irradiar energía de radiofrecuencia y, si no se instala y utiliza de acuerdo con las instrucciones, podría ocasionar interferencias perjudiciales en las comunicaciones de radio. Es probable que el funcionamiento de este equipo en una zona residencial cause interferencias perjudiciales, en cuyo caso será necesario que el usuario corrija las interferencias a sus expensas.

- **Declaración de cumplimiento de la Comunidad Europea (Class A):**

Este es un producto de Clase A. En un entorno doméstico, este producto puede causar interferencias de radio, en cuyo caso se puede instar al usuario a que tome las medidas oportunas..



El símbolo de la papelera con ruedas tachada indica que este producto no se debe arrojar a la basura municipal. En su lugar, es necesario deshacerse del equipo depositándolo en un punto limpio designado de reciclaje de equipos eléctricos y electrónicos.



Advertencia

1. No mire directamente a la fuente de luz de LED, ya que puede dañar la retina.

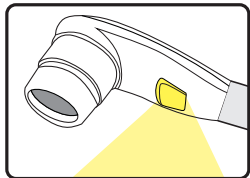

2. Transporte el producto sujetándolo por la parte inferior de la unidad principal con ambas manos. Nunca sujete el producto únicamente por el brazo o el cabezal de la cámara.

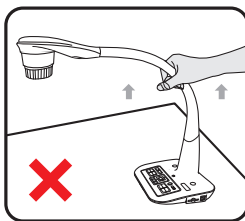
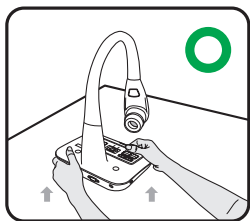

3. Preste atención para evitar que el cabezal de la cámara se golpee contra el escritorio o cualquier objeto duro..
4. Nunca gire el brazo en dirección opuesta.
5. Mantenga una mano en la base del dispositivo mientras ajusta el brazo y la cabeza de la cámara.

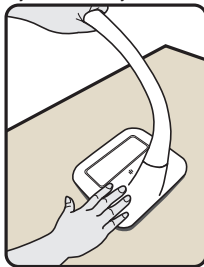

Preparar la cámara de documentos

- Familiarizarse con las partes de la cámara de documento

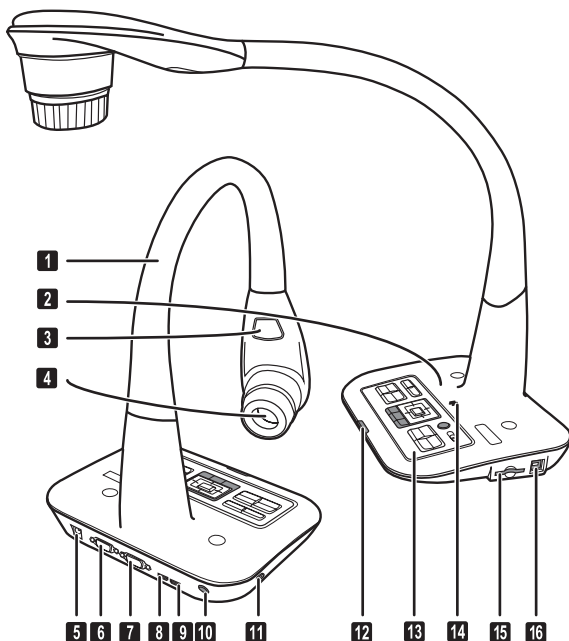

- 1 Brazo en forma de cuello de cisne
- 2 Micrófono
- 3 Lámpara LED
- 4 Cabezal de la cámara
- 5 Toma de alimentación de CC de 5V
- 6 Puerto de salida VGA
- 7 Puerto de entrada VGA
- 8 Puerto Salida HDMI
- 9 Puerto entrada HDMI
- 10 Receptor de señal del mando a distancia
- 11 Ranura antirrobo
- 12 Receptor de señal del mando a distancia
- 13 Panel de control
- 14 Altavoz
- 15 Ranura de tarjeta SD
- 16 Puerto USB

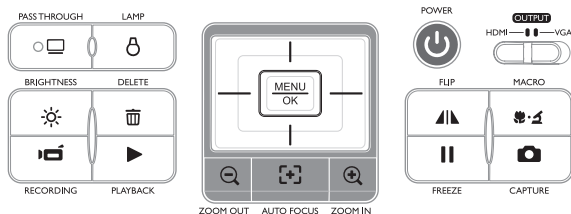

● Panel de control



Botón	Función	Botón	Función
	Permite encender y apagar la alimentación		Alejar
	Permite girar la imagen de 180° en 180°		Acercar
	Permite conmutar entre el modo Macro y Normal		Auto-enfoque de una sólo vez
	Permite congelar la imagen actual		Activar el modo PC para habilitar la función "CAMBIAR"
	Permite capturar una imagen estática		Encender/apagar y ajustar el brillo de la lámpara LED
MENU OK	Mostrar Menú y seleccionar		Tecla acceso directo de brillo
	Botones de dirección		Eliminar archivos de la memoria cuando se encuentra en modo de reproducción
OUTPUT HDMI — VGA	Switch de salida HDMI-VGA		Grabar un vídeo y un clip de audio
			Activar el modo de Reproducción para ver los clips de vídeo grabados y las imágenes tomadas

● Mando a distancia

Botón	Función
	Tecla acceso directo de brillo
	Permite encender y apagar la unidad
	Permite congelar la imagen actual.
ICON	Permite mostrar u ocultar los iconos en la pantalla
	Permite mostrar u ocultar el menú OSD
	Permite entrar en el modo de reproducción para mostrar las imágenes y los clips de vídeo grabados
	Permite girar la imagen de 180° en 180°
	Utilice estos botones para seleccionar una opción y realizar ajustes
	Permite grabar un clip de vídeo
	Permite capturar una imagen estática
	Permite reducir y ampliar la imagen
	Enfoque automático con un disparo
	Permite utilizar la barra de nivel para ajustar el enfoque manualmente
	Permite establecer rápidamente el zoom digital 2X o 4X
	Permite resaltar la función de activación y desactivación
	Permite enmascarar la función de activación y desactivación
	Permite conmutar entre el modo Macro y Normal
	Permite ajustar el tamaño de la sección resaltada o enmascarada mediante las teclas de dirección
	Permite establecer el color del área exterior de la sección resaltada o enmascarada mediante las teclas de dirección

Botón	Función
	Permite subir o bajar el volumen de sonido
	Permite activar y desactivar la función Imagen en imagen *Para mostrar una imagen estática como una imagen pequeña durante la reproducción de la imagen

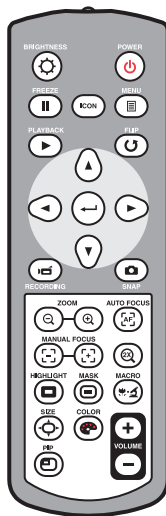

- ! El mando a distancia de infrarrojos solamente funciona a una distancia cercana de la unidad.
- ! Inserte las pilas correctamente conforme a los símbolos "+" y "-"
- ! El mando a distancia utiliza dos pilas de tipo AAA. No utilice pilas nuevas y usadas ni tipos diferentes de pilas juntas.

Configuración

En esta sección se proporcionan sugerencias útiles sobre la forma de ajustar la cámara de documentos sin problemas conforme a sus necesidades.

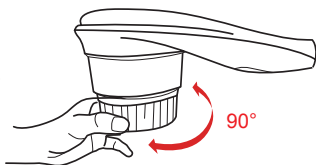

● Función de rotación

Girar el rotor de la lente para rotar la imagen 90°



● Lámpara de iluminación

Si está en un entorno oscuro, encienda la luz LED para tener una exposición mejor.

1. Pulse el botón de la luz LED () en la base para encender o apagar la luz LED.
2. Ajuste el brillo pulsando el botón de la luz ()

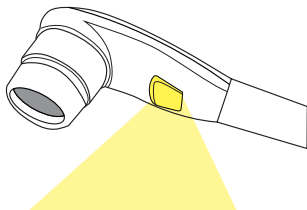

● Switch de salida

Ajuste el switch de salida del panel de control de acuerdo con su puerto de salida.

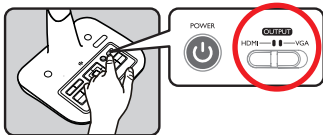

● Brazo en forma de cuello de cisne

El brazo en forma de cuello de cisne para conseguir un área de trabajo diferente.

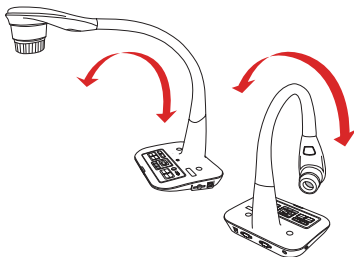

● Área de trabajo

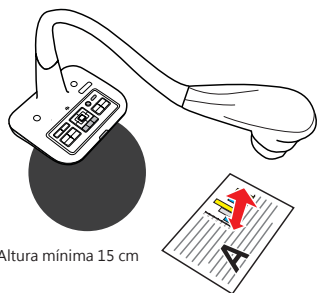
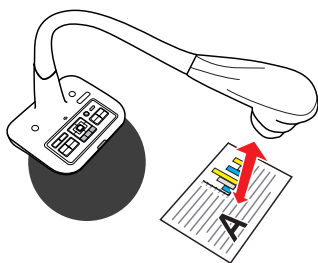
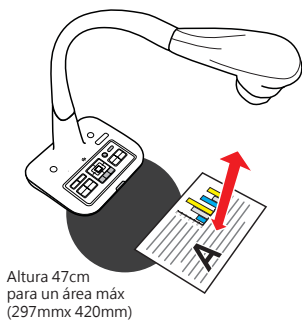
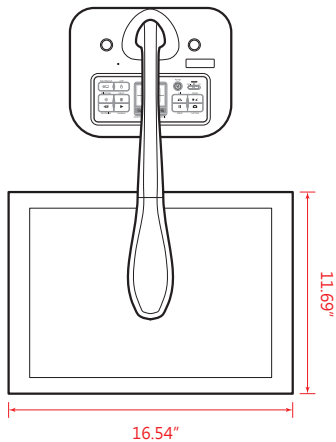

❗ Si no coloca el documento en el área de trabajo recomendada, la imagen se debe girar mediante el botón VOLTEAR (🔄) del panel de control o del mando a distancia.

● Ajustar el brillo

1. Presione el botón MENÚ (☰)(⚙️) y seleccione el modo Brillo.
2. Utilice los botones (◀️ or ▶️) para aumentar o reducir el nivel de brillo.

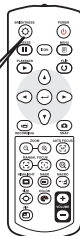
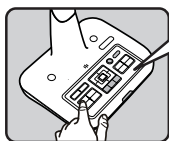

● Ajustar el tamaño

Use boton de zoom (⊕ / ⊖) para reducir y ampliar la imagen.

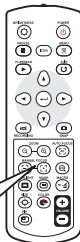
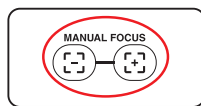
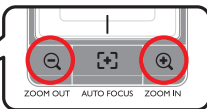
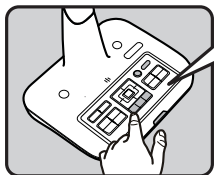

● Función de volteo

Pulse el botón Flip para voltear la imagen (↕️).

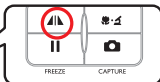
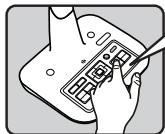

● Ajustar el brillo enfoque

► Automatic focus

Presione el AF botón (AF) to automatically focus. This function provides a one-shot autofocus.

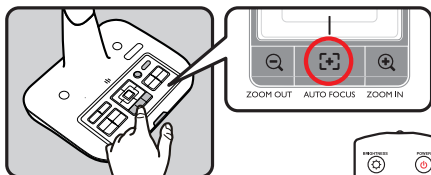

► Manual de enfoque

Presione el manual de enfoque botón ([-]/[+]) on remote control to finetune the focus.



● Antideslumbramiento

La lámina antideslumbramiento es un plástico transparente que se superpone en la parte superior de un objeto o superficie para reducir el deslumbramiento.

Para usar esta lámina antideslumbramiento, solamente tiene que colocarla sobre el objeto o superficie brillante (como una revista) para reducir la reflexión de la luz.

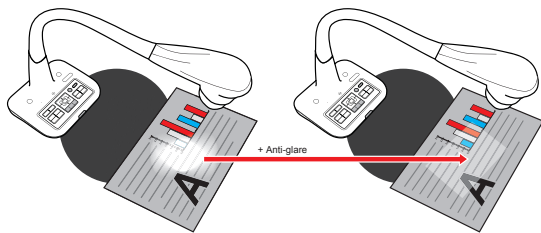



● Ajuste del balance de blancos

1. El ajuste predeterminado de ajuste de blancos de la cámara es "Auto" .
2. Hay varios modos (Auto, Fluorescente, Tungsteno y Personalizado) entre los que elegir según el entorno.
3. Balance de blancos personalizado:

Pulse el botón "MENU" ($\frac{\text{MENU}}{\text{OK}}$) → Balance de blancos → entre en el modo "Personalizado" .

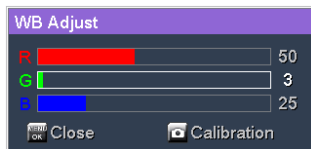
Aparecerá una ventana emergente como la siguiente:



Pulse el botón CAPTURE () para obtener los datos de la imagen actual.

Utilice la "Tecla de dirección" () para ajustar el número de los parámetros

R, G y B.

Pulse el botón " OK" ($\frac{\text{MENU}}{\text{OK}}$) para finalizar el ajuste y cerrar la ventana.

● Insertar y expulsar una tarjeta SD/SDHC (no suministrada)

1. Inserte la tarjeta con la etiqueta hacia arriba hasta que llegue al final de la ranura.
2. Cuando la tarjeta se inserte correctamente, el icono () aparecerá en la pantalla y no se podrá acceder a la memoria interna.
3. Para quitar la tarjeta, empujela para liberarla y, a continuación, tire de ella suavemente para extraerla.

- ⚠ No desconecte la alimentación mientras da formato a la tarjeta SD.
- ⚠ Asegúrese de utilizar este producto para dar formato a la tarjeta SD. Si ya ha dado formato a la tarjeta SD con un equipo, vuelva a darla formato con la unidad principal.
- ⚠ Si no hay un almacenamiento externo conectado, todos los archivos se guardarán en la memoria integrada.

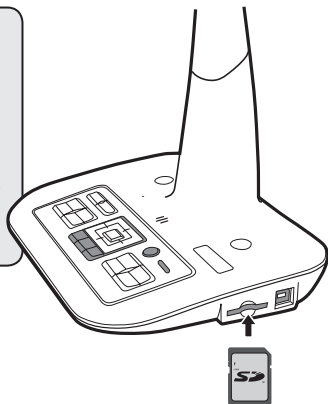

Realizar las conexiones

● Diagrama del sistema

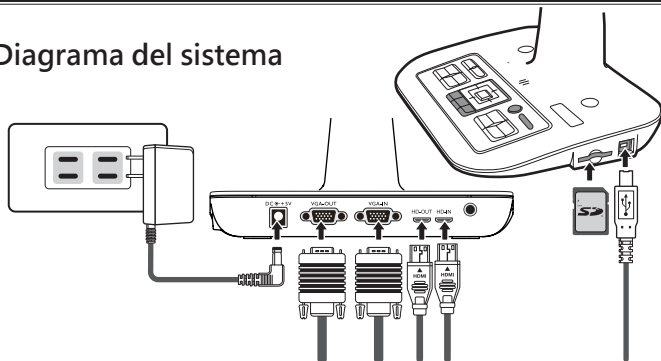

Paso 1 / Enchufar la toma de corriente

Utilice el adaptador de alimentación para conectar el conector ENTRADA DE CC del producto en una toma de corriente estándar de 100 VCA~240 VCA.

! El tipo de adaptador de corriente está en función de sus países / regiones.

















Paso 2 / Resolución de salida y relación de aspecto

Varias resoluciones de salida están disponibles en función de la configuración de relación de aspecto y de salida. Por favor, consulte la tabla que aparece a continuación:

Salida	Relación de Aspecto	Resolución	Frecuencia Vertical
VGA	4:3	1024 x 768	50 / 60 Hz
		1600 x 1200	
HDMI	16:9	1280 x 720	50 / 60 Hz
		1920 x 1080	

*La cámara de documentos bajará la resolución de salida de forma automática cuando el dispositivo de visualización conectado no admita una resolución mayor.

Paso 2 /Conectar un monitor o proyector

	Puerto del producto	Cable	Display Port de dispositivos	PC Port
VGA	 RGB OUTPUT		 RGB INPUT	
	 RGB INPUT			 RGB OUTPUT
HDMI	 Salida Mini HD		 HDMI-INPUT	
	 Entrada Mini HD			 HDMI-OUTPUT
USB	 Puerto TYPO B		 Puerto TYPO A	 Puerto TYPO A

► TV estándar

• Conectar a través de SALIDA VGA

Para mostrar imágenes, puede utilizar el cable VGA para conectar el conector SALIDA VGA del producto al puerto RGB del televisor.

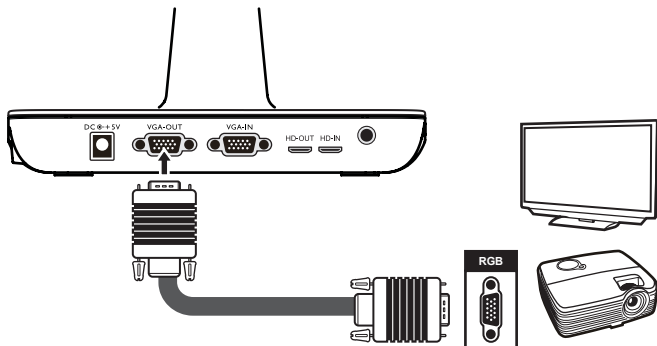

● Conectar su PC

► Conectar a través de un cable VGA

Utilice el cable VGA para conectar el conector ENTRADA VGA del producto al conector SALIDA VGA de su PC

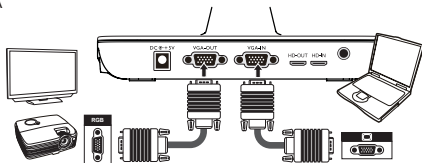

► Usar cable HDMI para hacer passthrough

Utilice el cable HDMI para conectar el conector HD IN en la cámara de documentos al conector HD Out del ordenador.

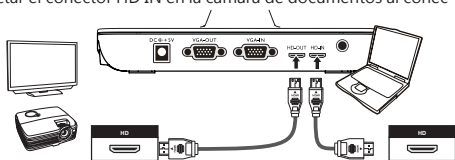

- ❗ Para mostrar la imagen del equipo, presione el botón PC () del panel de control.
- ❗ For different command, please refer to your laptop manual. Para establecer el modo de visualización de salida en un equipo portátil, utilice el comando del teclado (Fn +) para cambiar entre los modos de visualización. Para obtener información de los diferentes comandos, consulte el manual del equipo portátil.
- ❗ La señal es solamente paso a través desde el puerto ENTRADA VGA al puerto SALIDA VGA en la cámara de documentos. No se puede mostrar imagen de PC en el panel LCD de 3" . Conecte un dispositivo de salida para mostrar la imagen de su PC.

► Conectar a través de USB







Presione el botón MENÚ () → seleccione "Conexión USB"

Elija "Disco" para conectar un dispositivo de almacenamiento masivo.















Elija "Cámara de PC" para que sea como una cámara de PC.



















Operaciones básicas







1. Presione el botón MENÚ () del mando a distancia o del panel de control ($\frac{\text{MENU}}{\text{OK}}$).
2. Presione el botón ( or ) para alternar entre fichas.
3. Presione () ($\frac{\text{MENU}}{\text{OK}}$) para realizar una selección y mostrar las selecciones de configuración.
4. Utilice ( or ) para ajustar la configuración.
5. Presione () ($\frac{\text{MENU}}{\text{OK}}$) para activar la nueva configuración.
6. Presione el botón MENÚ ($\frac{\text{MENU}}{\text{OK}}$) de nuevo para ocultar el menú OSD.

● Opciones de menú en el modo de vista previa

Elemento	Icono	Opción	Descripción
Brillo		-	Utilice los botones Derecha e Izquierda para proporcionar más brillo o más oscuridad a la imagen
Efecto		Gráfico	Si elegis el grafico, los colores del tu archivo seran mas brillante y mas claro,Ejemplo: foto, tableta.
		Texto	Esta funcion es para disenar especialmente a las letras o archivos con colores blancos ynegros, Ejemplo: Letras, lineas negras.
		B/N	Para generar una imagen de cámara en blanco y negro. Para facilitar la visualización de la imagen, seleccione esto cuando capture documentos en blanco y negro, etc.
		Negativo	TPara generar una imagen de cámara negativa.
		Sketch	TPara generar una imagen de cámara sketch.
Balance de blancos		Auto	Hay varios modos (Auto, Fluorescente, Tungsteno y Personalizado) entre los que elegir según el entorno o.
		Fluorescente	
		Tungsteno	
		Personalizado	
Zoom rápido		2X / 4X	Establezca el zoom rápido en 2X o 4X.
Enfoque		Normal	Seleccione el modo Estándar para 35cm ~ ∞.
		Macro / Microscopio	Seleccione el modo Macro/Microscopio para obtener primeros planos o cuando conecta un microscopio.
Resolución estática		0.8M / 2M 5M / 8M	Seleccione la resolución estática que desee.

Elemento	Icono	Opción	Descripción	
Modo de vídeo		Alta calidad	Seleccione el modo de vídeo deseado	
		Alta velocidad de cuadro		
SETTING		Activar/ Desactivar	Habilitar o deshabilitar el sonido del pitido	
		50Hz / 60Hz	Establecer la frecuencia en 50 Hz o 60 Hz. La configuración de parpadeo se basa en la norma de frecuencia de la fuente de alimentación eléctrica local.	
	Conexión USB		Desactiva	El efecto va más fuertes como el aumento del número
			Disco	Seleccione "Disco " para entrar en el modo de almacenamiento masivo
			Cámara de PC	Seleccione "Cámara de PC " para entrar en Modo Cámara de PC
	Salida HDMI		720p	Ajustar resolución salida HD
			1080i	
	Salida VGA		XGA	Ajustar resolución salida VGA
			UXGA	
	Reloj		-	Establecer la fecha y hora
	Idioma		-	Permite seleccionar el idioma en el que se mostrarán los menús OSD
	Format		No / Sí	Dar formato al medio de almacenamiento. Tenga en cuenta que todos los archivos almacenados en el medio se perderán.
Reset default		No / Sí	Restaurar los valores predeterminados de fábrica. Tenga en cuenta que se sobrescribirá la configuración actual.	
Salir		-	Salir	









● Opciones de menú en el modo Reproducción

Elemento	Icono	Option	Descripción
Supprimer un		No / Sí	Eliminar el archivo actual
Supprimer tout		No / Sí	Eliminar todas las imágenes del mismo tipo almacenadas en la memoria.
Diaporama		Activar/ Desactivar	Iniciar una presentación de diapositivas
Info fichier		-	Ver el título del archivo, la fecha y hora en la que se guardó, el tamaño y la duración de grabación.
Volumen		-	Ajusta el volumen del vídeo en reproducción.
Cámara		-	Salte del modo playback y vuelve al modo de preview.

● Grabar un clip de vídeo / tomar una imagen fija

1. Establezca la captura o la resolución de grabación de acuerdo con la configuración, por favor consulte la tabla de abajo according to the setting, please refer to the table below:

Switch de salida	Configuración de resolución	Resolución de captura	Resolución de grabación
VGA	XGA	1024 x 768	1024 x 768
	UXGA	1600 x 1200	
HDMI	720P	1280 x 720	1280 x 720
	1080i	1920 x 1080	1920 x 1080

2. Elija el modo de enfoque en función de la distancia al objeto:
Establezca el modo de enfoque en Normal para 37cm a ∞.
Establezca el modo de enfoque en Macro () or () para 7cm a 37cm.
3. Utilice el botón Zoom ( / ) para acercar o alejar la pantalla.
4. Enfoque automático y enfoque manual
Presione el botón () para enfocar automáticamente. Esta función proporciona un enfoque automático para un disparo. Utilice el botón de enfoque manual ( / ) del mando a distancia para ajustar el enfoque con precisión.
5. Presione el botón Grabar () para iniciar la grabación y vuelva a presionarlo para detener dicha grabación. Presione el botón Snap () para tomar una imagen fija.

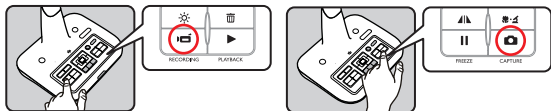

● Reproducir

1. Presione el botón REPRODUCIR ().



2. La última imagen o clip de vídeo grabado comenzará a reproducirse.
3. Utilice el botón Arriba o Abajo para cambiar de archivo.

● Copiar archivos a su PC

Tenga en cuenta que los clips de vídeo se graban en formato AVI y se recompilan como CLIPxxxx.avi (donde xxxx son cuatro números en serie).

Antes de ver estos vídeos en su PC, puede que tenga que instalar algunos programas especiales.

1. Encienda el producto.
2. Conecte el producto a su PC mediante un cable USB.
3. Presione MENÚ ($\frac{\text{MENU}}{\text{OK}}$) → seleccione "Conexión USB" → elija "Disco". Se detectará la memoria interna o la memoria externa.

A continuación, puede ver los datos de imagen en una tarjeta SD o en un visor de PC, o simplemente cortando el archivo y pegándolo en su PC.

❗ Cuando el panel operativo o el mando a distancia esté en funcionamiento, no conecte o desconecte el cable USB, ya que el producto podría averiarse. Es decir, se podría producir un mal funcionamiento.

● Utilizar el producto como una cámara de PC

Iniciar la aplicación

1. Conecte el producto a su PC.
Encienda el equipo y, a continuación, conecte el cable USB al puerto USB de su PC. Asegúrese de que el conector y el puerto están bien alineados. Cambiar al modo Cámara de PC. Conecte el otro extremo del cable USB a la unidad principal.
Encienda la unidad o presione MENÚ ($\frac{\text{MENU}}{\text{OK}}$) → seleccione Conexión USB → seleccione Cámara de PC () y presione el botón Aceptar para confirmar la selección.
1. Iniciar la cámara de PC
Cuando el producto esté correctamente conectado al equipo y éste lo detecte, podrá iniciar su aplicación preferida para usar la función Cámara de PC.

Utilización de Smart DC

1. Asegúrese de que el ajuste de conexión USB esté en "PC-Cam" .
2. Conecte el dispositivo y el PC con el cable USB adicional.
3. Ejecute Smart DC en su PC.

Operaciones avanzadas

● Función Resaltar / Función enmascarar

Función Resaltar



1. Si desea destacar una sección concreta de la imagen de salida, puede utilizar la pantalla Resaltar.
2. Presione el botón Resaltar () del mando a distancia y utilice los botones de dirección para mover el área resaltada.

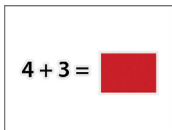

Función Enmascarar

1. Puede enmascarar una sección de la imagen de salida.
2. Presione el botón Enmascarar () del mando a distancia y utilice los botones de dirección para mover el área enmascarada.



- ❗ Presione el botón Tamaño () del mando a distancia y utilice los botones de dirección para ajustar el tamaño resaltado o enmascarado.
- ❗ Presione el botón Color () del mando a distancia y utilice los botones de dirección para ajustar el color del área resaltada o enmascarada.

● Función Imagen en Imagen (PIP, Picture in Picture)

1. Presione el botón PIP () para mostrar una imagen estática de un cuarto de tamaño alrededor en una pantalla de cámara en directo.
2. Utilice el botón Arriba o Abajo para mover la imagen estática al lado superior izquierdo e inferior izquierdo.

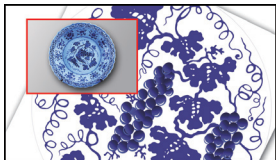

● Conectar un microscopio

La conexión de un microscopio permite examinar objetos microscópicos en una pantalla grande.

1. Ajuste el microscopio y enfoque los objetos.
2. Elija un adaptador de microscopio adecuado.
3. Los accesorios del adaptador de microscopio son aplicables al ocular: Ø28 mm, Ø31 mm, Ø33 mm y Ø34 mm.

- ❗ Para oculares de Ø33 mm y Ø34 mm solamente se debe instalar un adaptador de microscopio con la etiqueta Ø33 mm o Ø34.
- ❗ Para el ocular de Ø28 mm, inserte el adaptador de Ø28 mm en el ocular de Ø33 mm o Ø34 mm.
- ❗ Para el ocular de Ø31 mm, inserte el adaptador de Ø31 mm en el ocular de Ø33 mm o Ø34 mm.

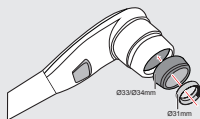
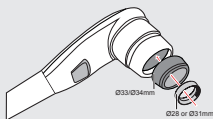
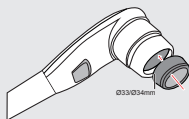

4. Monte el adaptador de microscopio en la lente.

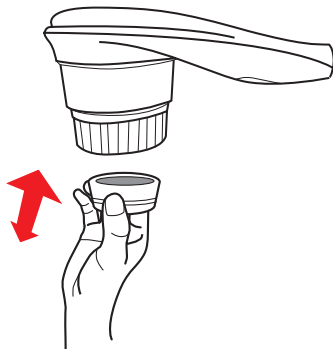

5. Cambie el modo de enfoque a Macro
Presione MENÚ($\frac{\text{MENU}}{\text{OK}}$)--> seleccione Enfoque
(\oplus) --> seleccione Macro



o presione el botón Macro (\oplus) del mando a distancia.

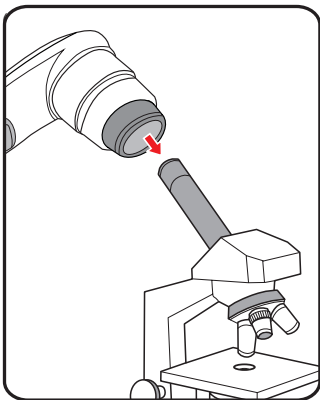

- ❗ Si la imagen no es nítida, ajuste el enfoque del micrófono.
- ❗ Presione el botón AF ($\boxed{+}$) o utilice el botón de enfoque manual del mando a distancia para ajustar el enfoque con precisión.

Almacenamiento

1. Apague el producto.

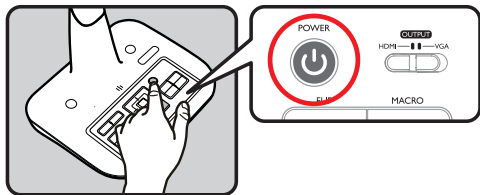

2. Desenchufe el adaptador de CA de la toma de corriente de la pared. A continuación, desconecte el adaptador de CA y todos los cables.

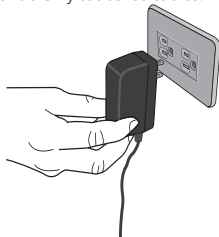

3. Pliegue el cabezal de la cámara y los brazos en la dirección mostrada en la figura.

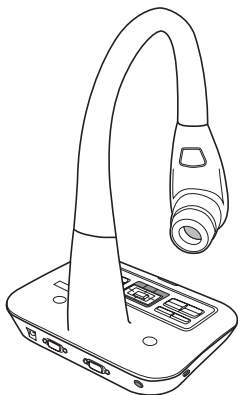

Solucionar problemas

Al utilizar la cámara de documentos :		
Problema	Causa	Solución
No se puede proporcionar alimentación normalmente.	El adaptador de CA no está correctamente conectado a la toma de corriente eléctrica o a la cámara de documentos.	Vuelva a conectar un extremo del adaptador de CA a la cámara de documentos y el otro extremo a una toma de corriente eléctrica.
No se hacen fotografías ni grabar clips de vídeo.	Memoria insuficiente.	Libere espacio de la tarjeta SD/MMC o la memoria interna.
	Se está utilizando una tarjeta SD "protegida" .	Establezca la tarjeta SD para poder escribir en ella.
No hay salida de imagen después de realizar la conexión.	La cámara de documentos no está bien conectada al dispositivo externo.	Vuelva a conectar todos los cables correspondientes con el dispositivo externo correctamente.
	Tipo de entrada incorrecto de dispositivo de salida de visualización.	Configure el tipo de entrada correcto de dispositivo de salida de visualización.
	Resolución admitida incorrecta de dispositivo de salida de visualización.	Configure la resolución admitida correcta de dispositivo de salida de visualización.
	Puerto de salida incorrecto seleccionado mediante el conmutador de salida en la cámara de documentos.	Configure el puerto de salida correcto mediante el conmutador de salida.
	El indicador del botón paso a través de PC está activado.	Presione el [] botón de paso a través de PC para desactivar la función.

Al utilizar la cámara de documentos :		
Problema	Causa	Solución
La imagen está borrosa	Probablemente el objeto está demasiado cerca de la lente.	Presione el botón AF para enfocar automáticamente o realice el ajuste presionando Enfoque manual.
		Seleccione el modo Macro si la distancia es inferior a 37 cm.
La imagen está invertida	El documento no está puesto en el área de trabajo recomendada.	Presione el botón [U] para ajustar la dirección.
La imagen no se mueve	La imagen de la cámara está establecida en [III].	Presione el botón [III] del panel de control de nuevo para anular la pausa.
El mando a distancia no funciona	No hay alimentación.	Replace the AAA batteries in the remote control.
	Algún objeto bloquea el receptor de señal del mando a distancia de la cámara de documentos.	Quite el objeto de bloqueo situado delante de la ámara de documentos.
	La distancia de uso es demasiado lejana.	Acérquese a la cámara de documentos para utilizar el mando a distancia.
La pantalla LCD muestra el mensaje "ERROR DE MEMORIA" o "ERROR DE TARJETA" . O bien, no puede leer la tarjeta de memoria.	El formato de la tarjeta de memoria no es compatible con la cámara de documentos.	Utilice la función "Formatear" de la cámara de documentos para dar formato a la tarjeta.
	La tarjeta de memoria está dañada.	Reemplace la tarjeta por una nueva.

Al utilizar la cámara de documentos :		
Problema	Causa	Solución
No se pueden eliminar las imágenes ni los vídeos y tampoco los puedo encontrar en la tarjeta de memoria.	Las grabaciones perdidas se guardan en la memoria interna.	Esto ocurre cuando inserta una tarjeta de memoria tras hacer algunas fotografías o grabar algunos vídeos. Puede obtener acceso a estos archivos cuando retire la tarjeta de memoria.
No puedo ver los vídeos en mi PC.	El software no está instalado en el equipo.	Instale Direct X 9.0c o una versión posterior y los códecs del Reproductor multimedia de Windows 9.0 para solucionar el problema. Vaya al sitio Web " http:// www.microsoft.com " para descargar los archivos necesarios.
La pantalla del televisor no muestra nada tras conectar el producto al mismo.	El producto no está bien conectado al televisor.	Vuelva a conectar el producto al televisor correctamente.
Al ver las imágenes en la pantalla LCD o el equipo aparece ruido.	La configuración de la frecuencia puede no coincidir con la norma del país en el que se encuentre.	Ajuste la configuración de la frecuencia.

! El contenido de este manual está sujeto a cambio sin previo aviso.