

MAXHUB

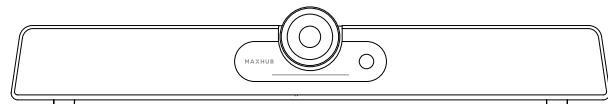

Note: All the pictures in this manual are for reference only, subject to our available products.

Integrated Video Conference Terminal User Manual

● Safety Warning and Precautions

Before using and operating this device, please read thoroughly and comply with the following precautions in order to prevent accidents or abnormal operation.

★ Operating Environment

- ① DO NOT place the product in dusty and humid environments in case of internal short circuit.
- ② DO NOT place the product near heating devices(such as lectrical heater).
- ③ Operating temperature is 0–40℃, operating humidity is 10%–90%RH.

★ Children Safety

- ① The product and accessories may contain some small parts. Please keep them from children to avoid accidental swallowing or danger.

★ Power Supply

- ① Please use the standard power adapter.

★ Keep Dry

- ① The product is NOT waterproof. Please keep it dry.

★ Maintenance

- ① Please contact technical support for maintenance services.
- ② DO NOT insert any sharp or pointed object into the device.
- ③ Prevent the device from falls and collisions with other objects, which may cause damages.

● Statement

- ① Intellectual property right statement: The patents cover the hardware design and software of this product. Anyone reproduces the product or the contents of this instruction without prior written permission from the Company shall be liable to legal prosecutions.
- ② The description, illustrations, etc. in this document may subject to change per the latest product specification and performance.
- ③ The product images are for illustrative purposes only and may slightly differ in appearance, colour, size, etc. from the actual product.
- ④ The company reserves the rights to improve and change the appearance and design of the product without notice.

● Accessories introduction

Please check the following items in the product box.

- USB cable × 1
- Remote control × 1
- Power adapter × 1
- Wall-mounted components × 1
- Peeping cover × 1

1. Product function

Please familiarize yourself with the interface and buttons of the device before using this device.

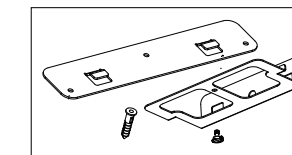
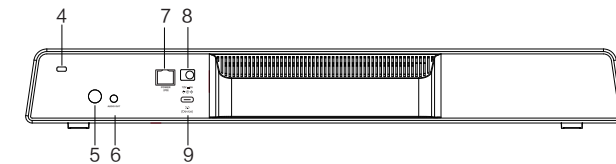
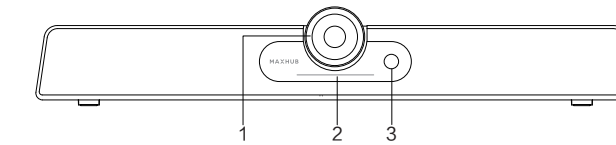

1	Camera
2	Indicator light
3	PIR: In power-on mode, it will automatically enter standby state if no moving object is detected within 3meters within 30minutes; In standby mode, it automatically starts up when detecting moving objects within 3meters.
4	Lockhole
5	Power Button: In startup mode, press the power button to mute. In standby mode, press the power button to power on.
6	AUDIO OUT: Used for external audio equipment

7	RJ45: Only support POE power supply
8	DC: Used for 12V power input power supply
9	3.0(Device): Connect USB host, upgrade system, etc
10	Wall-mounted components

2. Camera Usage

Method 1:

Place on the desktop.

Method 2:

Wall-mounted: Fix the bracket onto the Wall with screws (Figure 1).

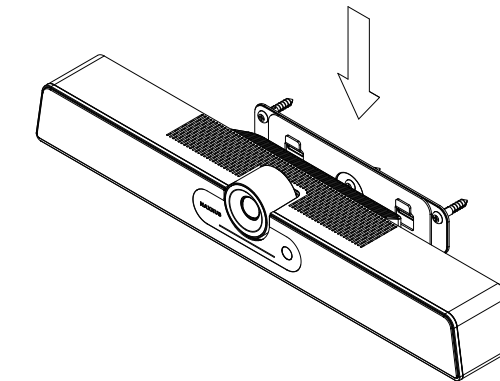

(Figure 1)

3. Connection

Please connect the device as shown below before use.

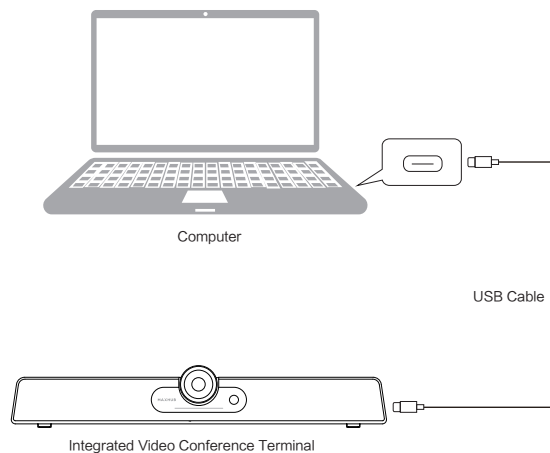

4. Quick Start

- ① Please use USB cable to connect this product to the computer.
- ② The device can be turned on after being connected to the power supply.
- ③ After successful startup, the product functions can be used.

5. Remote Control

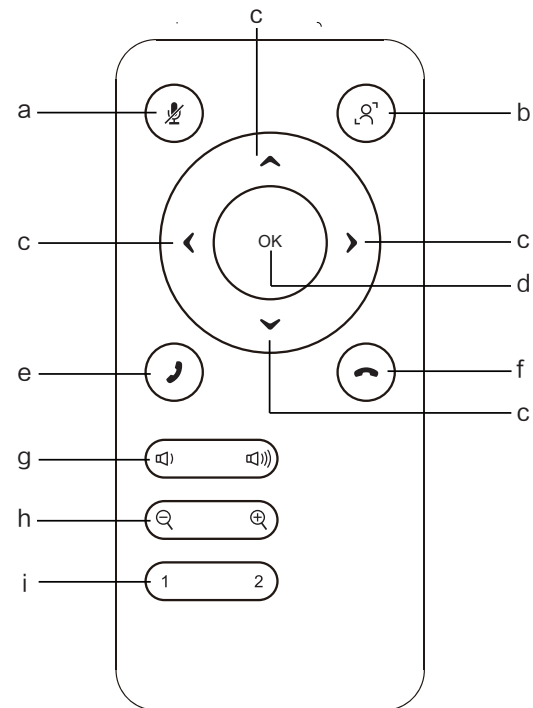

- a. : Mute Button, press to turn on or off the microphone.
- b. : Press to enable/disable the auto framing function. (After pressing the button, the screen will display the status, "" means open, "" means off.)
- c. : Direction Button. After zoom+/-, press the direction buttons to move the camera.

d. OK : Confirm Button.

① Camera image initialization function: Press to restore the camera image to its original state.

e. : Answer the calls.

f. : Hang up the calls.

g. : Volume Button, press to adjust the system volume.

h. : Digital Zooming, press to digitally zoom the camera. (Available only when auto framing is disabled). After zooming in, the direction button can move the picture.

i. Presets:

① When the camera is turned on, can set and switch the presets in settings. (Available only when auto framing is disabled).

② Press and hold the number button "1/2" for 2 seconds to save the current view as a preset.

③ Each preset contains zooming level, viewing angle information. Up to two presets are supported.

④ Press 1/2 to switch amongst the presets.

● FCC Caution:

This device complies with Part 15 of the FCC Rules. Operation is subject to the following two conditions: (1) This device may not cause harmful interference, and (2) this device must accept any interference received, including interference that may cause undesired operation.

● Federal Communication Commission Interference Statement

This equipment has been tested and found to comply with the limits for a Class B digital device, pursuant to Part 15 of the FCC Rules. These limits are designed to provide reasonable protection against harmful interference in a residential installation. This equipment generates, uses, and can radiate radio frequency energy and, if not installed and used in accordance with the instructions, may cause harmful interference to radio communications. However, there is no guarantee that interference will not occur in a particular installation. If this equipment does cause harmful interference to radio or television reception, which can be determined by turning the equipment off and on, the user is encouraged to try to correct the interference by one or more of the following measures:

- Reorient or relocate the receiving antenna.
- Increase the separation between the equipment and receiver.
- Connect the equipment into an outlet on a circuit different from that to which the receiver is connected.
- Consult the dealer or an experienced radio/TV technician for help.



This symbol, affixed to the product or its packaging, indicates that

the product must not be processed with household waste. It must be brought to an electric and electronic waste collection point for recycling and disposal. By the appropriate disposal of this product you also help in preventing potentially negative consequences for the environment and human health. The recycling of materials helps preserve our natural resources. For further information regarding the recycling of this product, please contact your municipality, local waste disposal centre or the store where the product was purchased.