

INSTALLATION INSTRUCTIONS

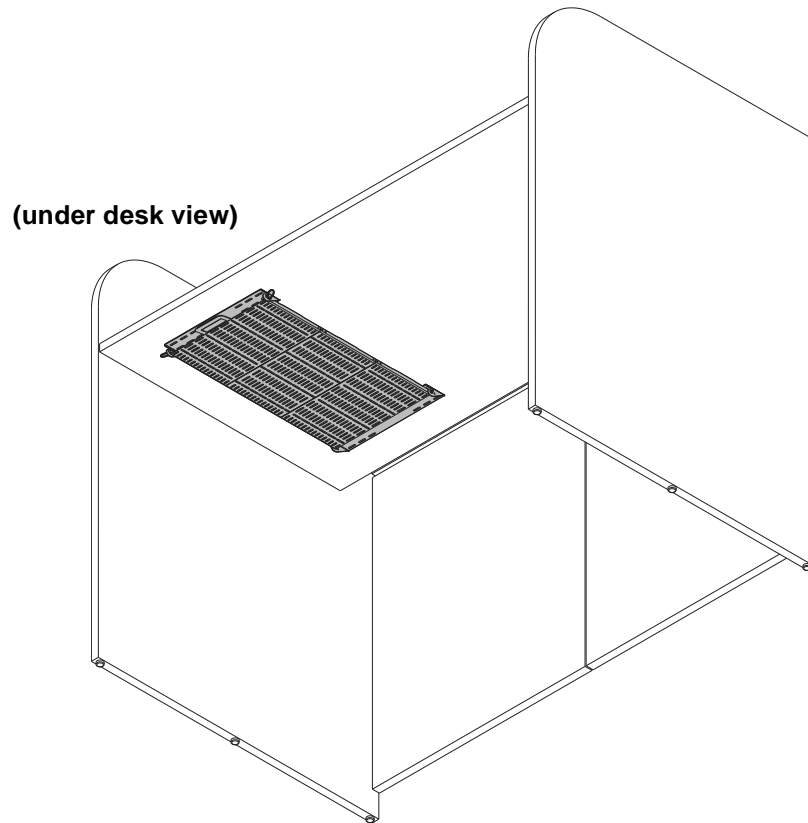

Under Desk Component Storage Panel

DISCLAIMER

Milestone AV Technologies and its affiliated corporations and subsidiaries (collectively "Milestone"), intend to make this manual accurate and complete. However, Milestone makes no claim that the information contained herein covers all details, conditions or variations, nor does it provide for every possible contingency in connection with the installation or use of this product. The information contained in this document is subject to change without notice or obligation of any kind. Milestone makes no representation of warranty, expressed or implied, regarding the information contained herein. Milestone assumes no responsibility for accuracy, completeness or sufficiency of the information contained in this document.

Chief® is a registered trademark of Milestone AV Technologies. All rights reserved.

DEFINITIONS

MOUNTING SYSTEM: A MOUNTING SYSTEM is the primary Chief product to which an accessory and/or component is attached.

ACCESSORY: AN ACCESSORY is the secondary Chief product which is attached to a primary Chief product, and may have a component attached or setting on it.

COMPONENT: A COMPONENT is an audiovisual item designed to be attached or resting on an accessory or mounting system such as a video camera, CPU, screen, display, projector, etc.



WARNING: A WARNING alerts you to the possibility of serious injury or death if you do not follow the instructions.



CAUTION: A CAUTION alerts you to the possibility of damage or destruction of equipment if you do not follow the corresponding instructions.



IMPORTANT SAFETY INSTRUCTIONS



WARNING: Failure to read, thoroughly understand, and follow all instructions can result in serious personal injury, damage to equipment, or voiding of factory warranty! It is the installer's responsibility to make sure all accessories are properly assembled and installed using the instructions provided.



WARNING: Failure to provide adequate structural strength for this accessory can result in serious personal injury or damage to equipment! It is the installer's responsibility to make sure the structure to which this accessory is attached can support five times the combined weight of all equipment. Reinforce the structure as required before installing the accessory.



WARNING: Exceeding the weight capacity can result in serious personal injury or damage to equipment! It is the installer's responsibility to make sure the combined weight of all components attached to this accessory does not exceed 20 lbs (9.07 kg).



WARNING: Use this accessory only for its intended use as described in these instructions. Do not use attachments not recommended by the manufacturer.



WARNING: Never operate this accessory if it is damaged. Return the accessory to a service center for examination and repair.



WARNING: Do not use this accessory outdoors.







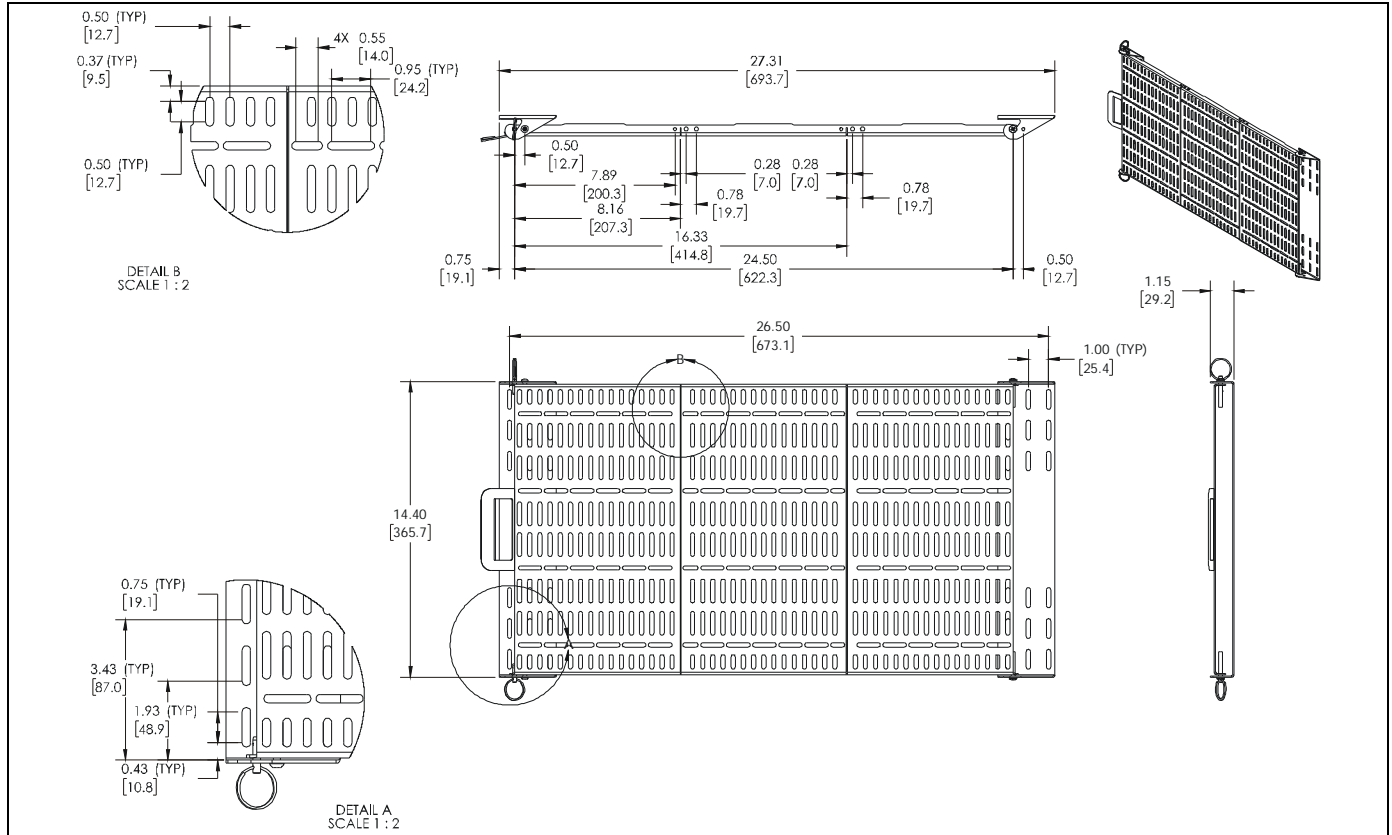

WARNING: RISK OF INJURY TO PERSONS! Do not use this accessory to support video equipment such as televisions or computer monitors.

--SAVE THESE INSTRUCTIONS--

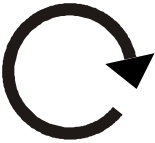
DIMENSIONS



LEGEND

	<p>Tighten Fastener Apretar elemento de fijación Befestigungsteil festziehen Apertar fixador Serrare il fissaggio Bevestiging vastdraaien Serrez les fixations</p>		<p>Pencil Mark Marcar con lápiz Stiftmarkierung Marcar com lápis Segno a matita Potloodmerkteken Marquage au crayon</p>
	<p>Loosen Fastener Aflojar elemento de fijación Befestigungsteil lösen Desapertar fixador Allentare il fissaggio Bevestiging losdraaien Desserrez les fixations</p>		<p>Drill Hole Perforar Bohrloch Fazer furo Praticare un foro Gat boren Percez un trou</p>
	<p>Phillips Screwdriver Destornillador Phillips Kreuzschlitzschraubendreher Chave de fendas Phillips Cacciavite a stella Kruiskopschroevendraaier Tournevis à pointe cruciforme</p>		<p>Security Wrench Llave de seguridad Sicherheitsschlüssel Chave de segurança Chiave di sicurezza Veiligheidssleutel Clé de sécurité</p>

TOOLS REQUIRED FOR INSTALLATION

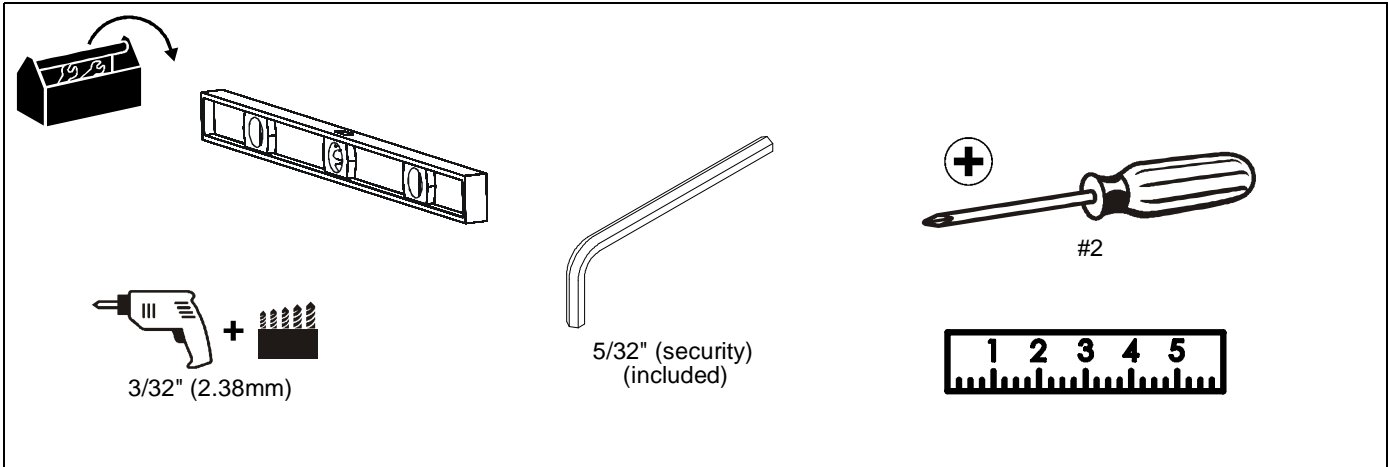

PARTS

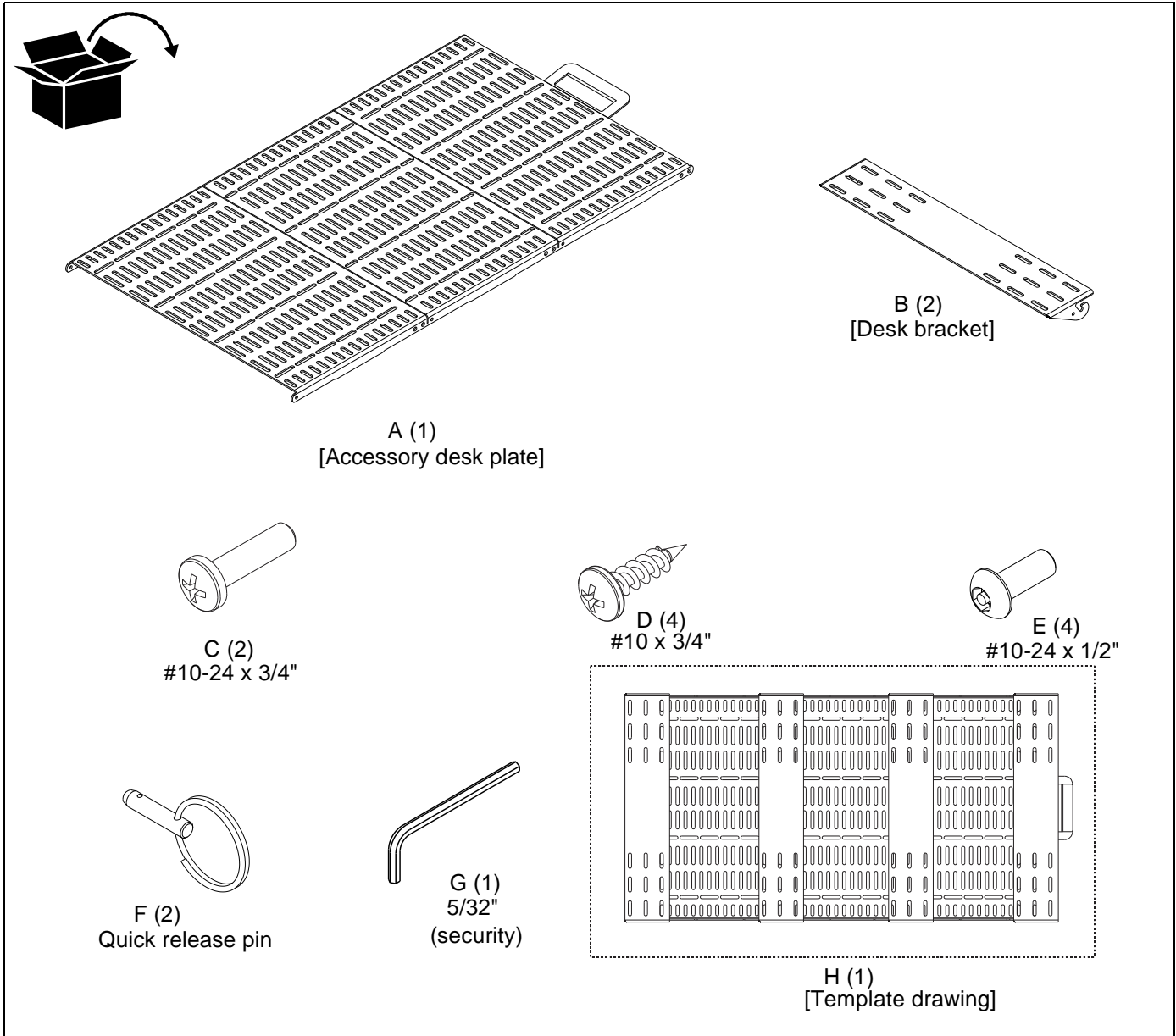

Assembly And Installation

CSPH Installation

1. Determine if entire accessory desk plate (A) will be used or if should be separated.
2. (Optional) Separate extra section(s) of desk plate (A) if necessary. The plate can be broken down into thirds depending on space available and user preference. (See Figure 1)

NOTE: Removed sections of desk plate can be used separately with a CSPHK bracket kit.

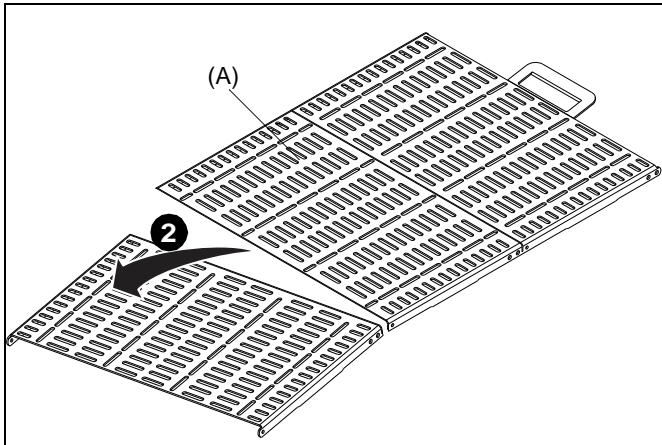

Figure 1

3. Use template drawing (H) to mark mounting holes on bottom of desk at desired mounting location. (See Figure 2)

NOTE: CSPH accessory can be installed in either direction depending on user preference

NOTE: Any of the nine mounting slots in each section may be used to mount plate to desk.

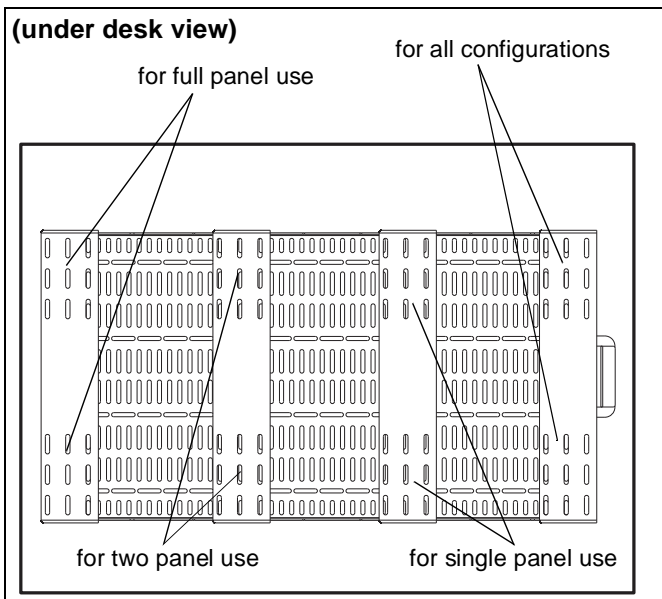

Figure 2

4. Drill four 3/32" pilot holes at marked locations under desk. (See Figure 3)

5. Use four #10 x 3/4" Phillips wood screws (D) to secure two desk brackets (B) to underside of desk. (See Figure 3)

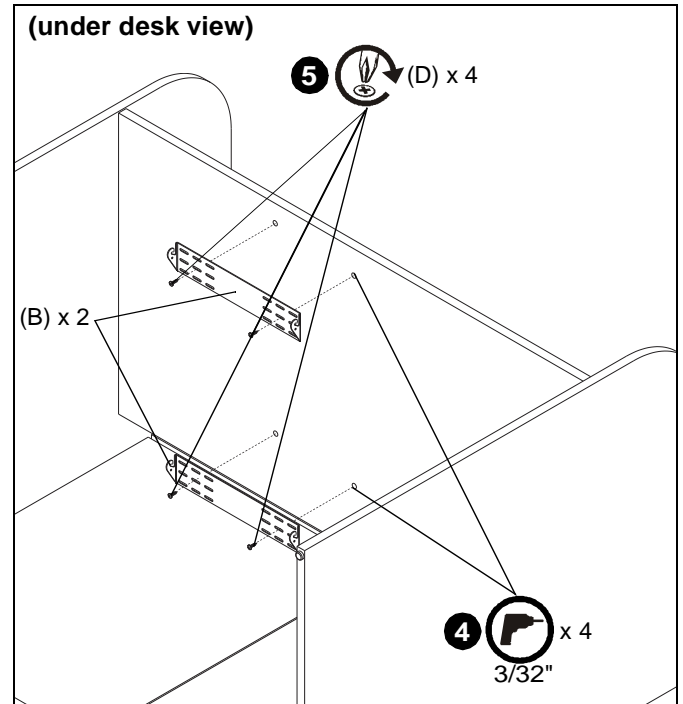

Figure 3

6. Loosely install two #10-24 x 3/4" Phillips pan machine screws (C) into bottom holes on accessory desk plate (A). Two #10-24 x 1/2" button head security screws (E) may be used in place of two Phillips screws (C) if greater security is desired. (See Figure 4)

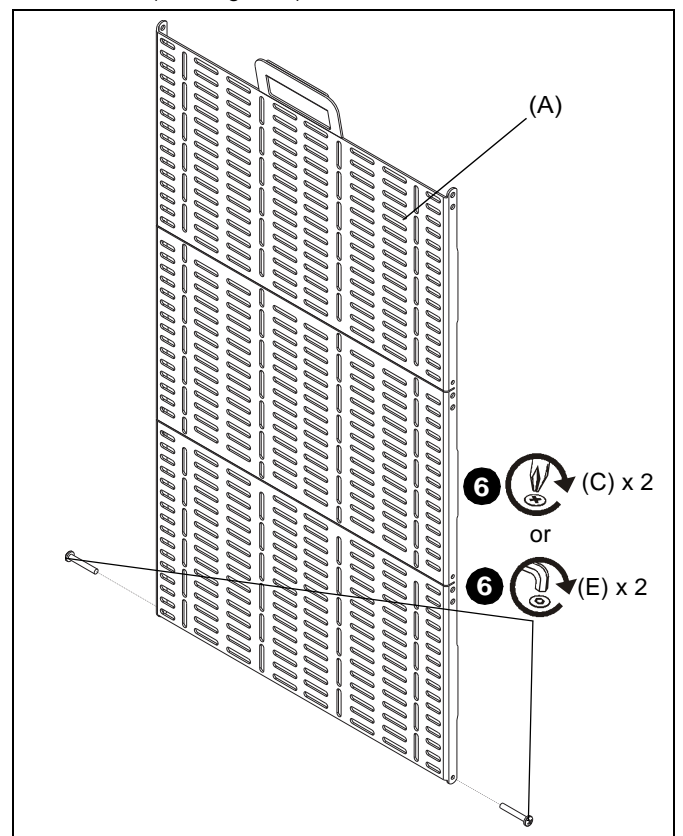

Figure 4

- Slide accessory desk plate (A) onto back desk bracket (B) until two screws (C) or (E) sit in slots of bracket (B). (See Figure 5)

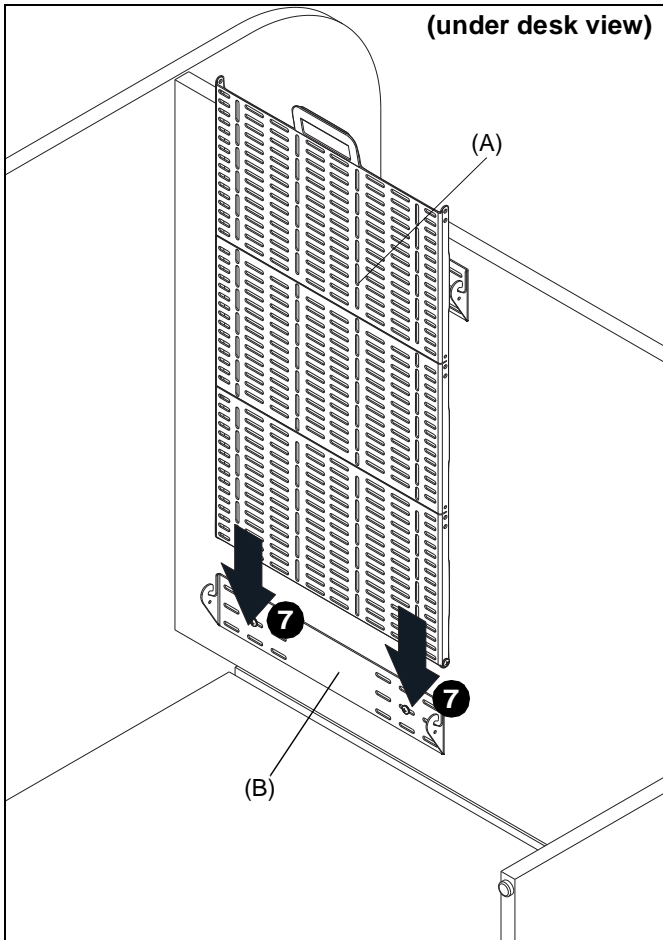

Figure 5

- Use either two quick release pins (F) or two #10-24 1/2" button head security screws (E) to secure accessory desk plate (A) to front desk bracket (B). (See Figure 6)

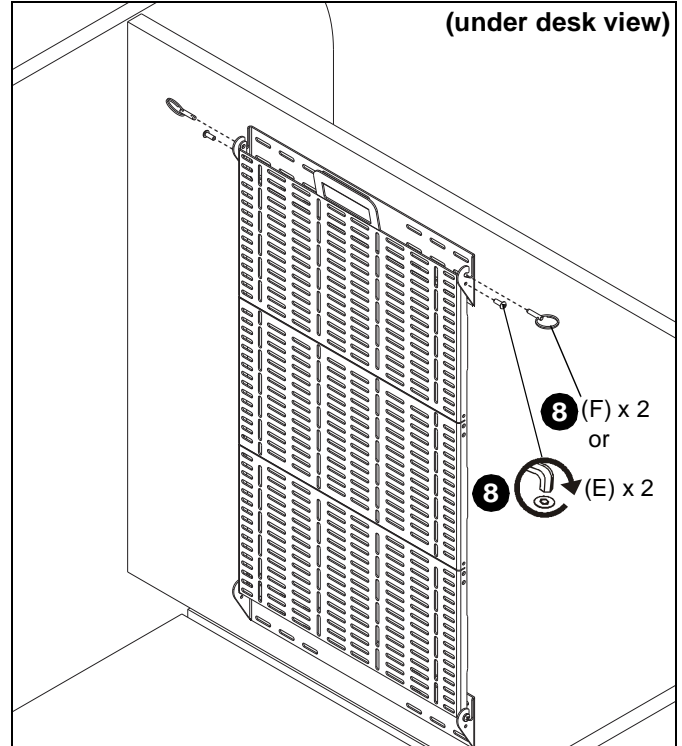

Figure 6

- Tighten all screws (C) or (E) holding accessory desk plate (A) to desk brackets (B). (See Figure 7)

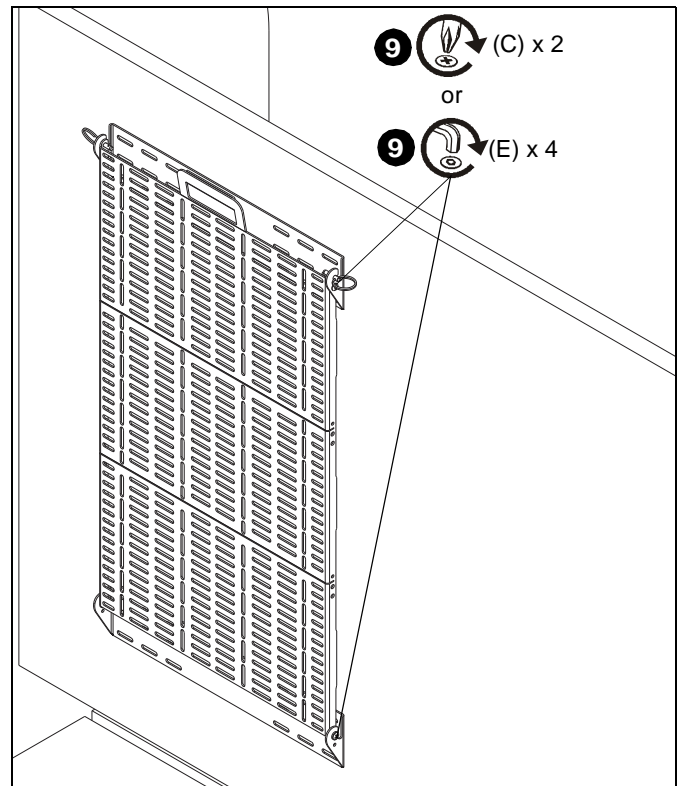

Figure 7

Component Installation



WARNING: Exceeding the weight capacity can result in serious personal injury or damage to equipment! It is the installer's responsibility to make sure the combined weight of all components attached to this accessory does not exceed 20 lbs (9.07 kg).

1. Install components to accessory desk plate (A) as desired using appropriate hardware (not provided) for each component.

Accessory Plate Removal

1. Remove security screws (E) or quick release pins (F) holding accessory desk plate (A) and to front wall bracket (B). (See Figure 8)
2. Grab handle and pull accessory desk plate (A) straight out until removed from desk brackets (B). (See Figure 8)

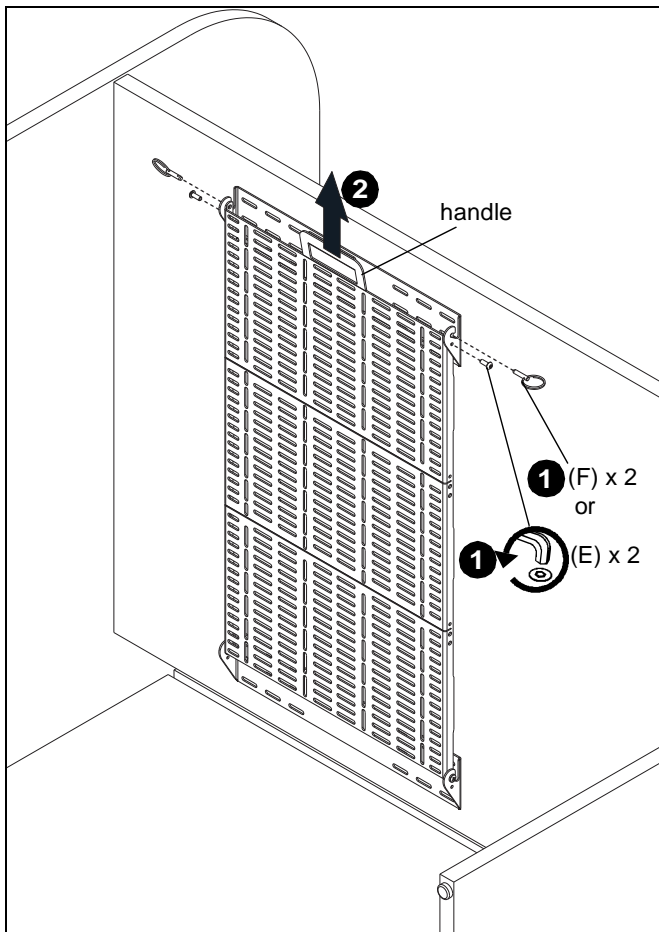

Figure 8



Our Mounts. **Your Vision.**

Chief, a products division of
Milestone AV Technologies

8800-002903 Rev01
©2017 Milestone AV Technologies
www.milestone.com
09/17

USA/International	A 6436 City West Parkway, Eden Prairie, MN 55344 P 800.582.6480 / 952.225.6000 F 877.894.6918 / 952.894.6918
Europe	A Franklinstraat 14, 6003 DK Weert, Netherlands P +31 (0) 495 580 852 F +31 (0) 495 580 845
Asia Pacific	A Office No. 918 on 9/F, Shatin Galleria 18-24 Shan Mei Street Fotan, Shatin, Hong Kong P 852 2145 4099 F 852 2145 4477

