



Complete Manual for

EasyIP Systems

Featuring the EasyIP Decoder, EasyIP Mixer, and EasyIP 10 Camera

Document 411-0041-35 Rev C
June 2020

Contents

Overview	1
What's in this Guide	1
The EasyIP Ecosystem	2
EasyIP Cameras	2
EasyIP Decoder	2
EasyIP Mixer	2
PoE+ Switch	2
Camera Features	2
Decoder Features	3
Mixer Features	3
Unpacking the EasyIP System Components	4
EasyIP 10 AV-over-IP PTZ Camera	4
EasyIP Decoder AV-over-IP Switching USB Endpoint	4
EasyIP Mixer AV Switcher	5
A Quick Look at the EasyIP Family	6
EasyIP 10 Camera	6
EasyIP Decoder	7
EasyIP Mixer	8
Installation	9
Don't Void Your Warranty!	9
Before You Start	9
Before Installing a Camera	10
Cabling Notes	10
Basic Connections – EasyIP Decoder and EasyIP 10 Cameras	11
Basic Connections – EasyIP Mixer	12
Using Dante Devices with the EasyIP Mixer	13
Installing the Wall Mount	13
About Ceiling-Mounted Cameras	13
Installing the Camera	14
Powering Up the EasyIP System	15
Initial Set-Up and Access to Administrative Controls	16
Browser Support	16
Initial Device Set-up Process Overview	17
About the Vaddio Device Controller	17
About the Vaddio Deployment Tool	17
Access and Initial Device Set-Up Using the Vaddio Device Controller	18
Initial Device Set-Up and Access Using the Vaddio Deployment Tool	19
Manual Access and Initial Device Set-Up	20
Initial Access to the Web Interface	20
Access the Web Interface of an EasyIP Decoder or EasyIP Mixer Manually	21

Access the Web Interface of an EasyIP Camera Manually	22
Next Steps for New Deployments	23
Web Interface Quick Reference	24
EasyIP Decoder Basic Operation – Operator's Pages	24
EasyIP Mixer Basic Operation – Operator's Pages	24
Administrative Pages	24
System Administration	26
Setting Passwords and Access	26
Configuring Other Security Settings	27
Changing the Hostname	28
Specifying Time Zone and NTP Server	28
Adding Room Information to the Device's Web Interface	29
Configuring System Behavior	30
Locating and Pairing to Cameras on the Network – EasyIP Decoder	30
Locating and Pairing to Cameras on the Network – EasyIP Mixer	32
Configuring Streaming Behavior	33
Viewing a Stream	33
Configuring USB Streaming	33
Configuring the USB Stream Format for Specific Applications	34
Locating and Pairing to Dante Devices	35
Configuring Audio Settings	37
Muting All Audio Inputs Together	37
Muting and Controlling Volume Per Input or Output	38
Enabling Phantom Power to Microphones – EasyIP Mixer	39
About Echo Cancellation	39
Fine-Tuning Microphone Performance – EasyIP Decoder	40
Fine-Tuning Microphone Performance – EasyIP Mixer	41
Fine-Tuning Speaker Performance – EasyIP Decoder	43
Fine-Tuning Speaker Performance – EasyIP Mixer	44
Synchronizing Audio with Video in the USB Stream – EasyIP Mixer	45
Routing Audio – EasyIP Mixer	46
Working with Video – EasyIP Decoder	48
Working with Video – EasyIP Mixer	49
Working with the EasyIP Mixer's Video Inputs	49
Configuring the EasyIP Mixer's Video Output	50
Working with Graphics – EasyIP Mixer	50
Setting up Macros and Triggers	53
Writing and Editing Macros	54
Testing Macros	55
Assigning Macros to Triggers	57
Testing Triggers	58

Example: Assigning a Function to the Connected Microphone's Home Button	58
Locking the Front Panel Controls – EasyIP Mixer	59
Configuring System Standby Behaviors	59
Configuring and Adjusting Cameras	60
Setting Cameras to Respond Independently to the IR Remote	61
Inverting the Image for Ceiling-Mounted Cameras	61
Setting the Home Position and Other Preset Shots	62
Renaming Presets	63
Adjusting the Color and Image Quality Settings	63
Lighting and Image Quality Quick Reference	64
Color Adjustment Quick Reference	65
Setting the Speeds for Manual Camera Movements	65
Setting the Speeds of Camera Movements to Presets	66
Setting the Direction for Camera Movements	66
Adjusting the Focus	67
Camera Indicator Light Settings	67
Other Camera Behavior Settings	68
System Maintenance	69
Saving (Exporting) or Restoring (Importing) a Configuration	70
Installing a Firmware Update	71
Installing a Firmware Update for a Connected Vaddio Microphone – EasyIP Decoder	72
Rebooting the Device	72
Using the Camera's Remote Control	73
Quick Reference	73
IR Remote Details	74
Storing a Preset Using the Remote	74
Clearing a Preset Using the Remote	74
Operating the System Using the Web Interface	75
Quick Steps: Muting and Standby	75
Working with Audio	76
Moving the Camera to a Preset Position	76
Accessing Camera Controls	77
Moving the Camera Manually	77
Selecting a PIP Source and Layout	78
Working with On-Screen Graphics – EasyIP Mixer	78
Telnet Serial Command API	80
Camera Commands	81
camera home	81
camera pan	82
camera tilt	83
camera zoom	84

camera focus	85
camera preset	86
camera ccu get	87
camera ccu set	88
camera standby	89
camera led	90
camera icr	90
Video Management Commands	91
video mute	91
video pip	92
video source	92
video type	93
Audio Management Commands	94
audio mute	94
audio volume	95
audio route	96
audio crosspoint-gain	97
Communication and Network Commands	98
camera authenticate	98
camera comm host	98
streaming settings get	99
network settings get	99
Control and Power Commands	100
trigger	100
camera standby	101
system standby	102
Maintenance and Troubleshooting Commands	103
camera recalibrate	103
network ping	103
system reboot	104
system factory-reset	104
version	105
Telnet Information and Session Management Commands	106
history	106
help	106
exit	106
Specifications	107
EasyIP 10 Camera	107
EasyIP Decoder	107
EasyIP Mixer	108
Troubleshooting and Care	109

System and Power issues	109
Camera	110
Audio	110
Status Indicator Light	111
Correct a Camera Motor Calibration Error	111
Restoring Factory Default Settings	113
Contacting Vaddio Technical Support	114
Viewing Diagnostic Logs	114
Operation, Storage, and Care	115
Glossary	116
Compliance and Conformity Statements	119
FCC Part 15 Compliance	119
ICES-003 Compliance	119
European Compliance	120
Photo Credits	121
Index	122

Overview

This guide discusses the following products:

- EasyIP 10AV-over-IP PTZ camera, 999-30200-000 (black, worldwide)
EasyIP 10 AV-over-IP PTZ camera, 999-30200-000W (white, worldwide)



- EasyIP Decoder AV-over-IP switching USB endpoint, 999-60210-000 (worldwide)



- EasyIP Mixer AV switcher, 999-60320-000 (worldwide)



What's in this Guide

This guide covers

- Unpacking
- Physical features
- Installation
- System administration and performance/behavior configuration
- Telnet API reference
- Specifications
- Troubleshooting
- Warranty and compliance/conformity information

For your convenience, the information you need to install EasyIP products is available in the smaller, stand-alone **Installation Guide for EasyIP AV-over-IP Systems**.

The EasyIP Ecosystem

Vaddio® EasyIP products are designed to be used together, and have limited or no compatibility with other types of products.

- EasyIP cameras deliver video in Vaddio's proprietary EasyIP format.
- An EasyIP Decoder or EasyIP Mixer is required to convert the cameras' output signal to an IP and/or USB stream.
- The decoder and mixer do not recognize other types of cameras.
- The decoder or mixer automatically detects EasyIP cameras on its own subnet.
- Cameras are not required to be on the same subnet as the device that manages them.
- EasyIP products require PoE+ power. Typically the EasyIP system is powered by a PoE+ switch.

EasyIP Cameras

EasyIP cameras may be installed anywhere on the network. They require only a PoE+ power connection. An EasyIP Decoder or EasyIP Mixer is needed to decode the AV-over-IP signal.

EasyIP Decoder

The decoder is the central component of a basic EasyIP installation. Its functions include

- Video – pair with up to four cameras at a time, control the active camera via web interface, and decode the camera's AV-over-IP signal.
- Audio – connect two Vaddio microphones and a speaker.
- USB streaming – configure for UVC-compliant or client-custom USB streaming for conferencing applications.

EasyIP Mixer

The mixer is the central component of a full-featured EasyIP pro AV room solution. Its functions include

- Video – pair with up to four cameras at a time, control the active camera via web interface, and decode the camera's AV-over-IP signal.
- Audio – connect two microphones and two speakers; pair with Dante® audio products on your network. Built-in audio mixer.
- USB streaming – configure for UVC-compliant or client-custom USB streaming for conferencing applications.

PoE+ Switch

A PoE+ switch simplifies installation, eliminating the need for PoE+ power injectors and placing all the connected products on the same subnet.

Camera Features

- 2.14 Megapixel effective, native 1080p/60 full HD image sensor
- 10x optical zoom, horizontal field of view of 67°
- Resolutions up to 1080p/60
- Precise pan and tilt movements at up to 90° per second
- Integration-ready Telnet control
- Pairs with an EasyIP Decoder, which provides video and audio connectivity and manages streaming
- Just one cable – the EasyIP connection to a PoE switch
- Enterprise-class IT administrative capabilities with full web controls for remote management

Decoder Features

- Uncompressed USB 3.0 streaming
- Streaming video resolutions up to 1080p/60
- Full-duplex audio streaming
- Audio inputs for two Vaddio microphones
- HDMI video output for local display
- Universal Video Class (UVC) and Universal Audio Class (UAC) drivers supported in Windows[®], macOS[®], and Linux operating systems, compatible with most UC conferencing applications
- Integration-ready Telnet control
- Pairs with up to four EasyIP 10 cameras on your network to provide control and manage streaming
- Enterprise-class IT administrative capabilities with full web controls for remote management

Mixer Features

- Uncompressed USB 3.0 streaming
- Streaming video resolutions up to 1080p/60
- Full-duplex audio streaming
- Line-level inputs for two microphones
- Line-level outputs for two speakers
- Audio mixer and video switcher
- Support for Dante[®] microphones and speakers
- HDMI video output for local display
- Universal Video Class (UVC) and Universal Audio Class (UAC) drivers supported in Windows[®], macOS[®], and Linux operating systems, compatible with most UC conferencing applications
- Integration-ready Telnet control
- Pairs with up to four EasyIP 10 cameras on your network to provide control and manage streaming
- Enterprise-class IT administrative capabilities with full web controls for remote management

Unpacking the EasyIP System Components

Make sure you received all the items you expected.

EasyIP 10 AV-over-IP PTZ Camera

Worldwide: 999-30200-000 (black), 999-30200-000W (white)



The box should contain these items:

- Camera (black or white)
- VaddioIR Remote Commander
- Thin Profile Wall Mount with mounting hardware
- Cat-5e cable, 10 ft. (3 m)
- Quick-Start Guide

Caution

Always support the camera's base when lifting or moving it. Lifting the camera by its head or mounting arm will damage it.



EasyIP Decoder AV-over-IP Switching USB Endpoint

Worldwide: 999-60210-000



The box should contain these items:

- EasyIP Decoder
- USB 3 cable, 6 ft. (1.8 m)
- Cat-5e cable, 3 ft. (0.9 m)
- 4-position Phoenix-type connector
- Half-rack mounting kit
- Quick-Start Guide

EasyIP Mixer AV Switcher

Worldwide: 999-60320-000



The box should contain these items:

- EasyIP Mixer
- Half-rack mounting kit
- 3-position Phoenix-style connectors (qty. 6)
- Cat-5 cable, 3 ft (0.9 m)
- USB 3.0 cable, type A to type B, 6 ft (1.8 m)
- Quick-Start Guide

A Quick Look at the EasyIP Family

- EasyIP 10 camera – Great video, simple installation, minimal set-up.
- EasyIP Decoder – Decodes the AV-over-IP signal from the camera(s) and originates a USB stream.
- EasyIP Mixer – Lovely and mostly symmetrical, hypoallergenic and guaranteed not to shed fur.

EasyIP 10 Camera

The EasyIP 10 camera delivers great video with simple installation and minimal set-up. Use it with an EasyIP Decoder or EasyIP Mixer.



Camera and zoom lens – 10X optical zoom lens.

IR sensor – Receives signals from the IR remote.

Status light – Multi-colored LED that indicates the camera's current state.

- Blue – Camera is active
- Purple – Standby mode or booting
- Yellow – Firmware update is in progress
- Blinking red – Video mute is on (UC color scheme)
- Blinking yellow – Motor out of calibration



Network/PoE+ – RJ-45 connector. Connect to a powered port on the PoE+ switch.

It doesn't get much easier than that, does it?

EasyIP Decoder

The EasyIP Decoder receives and decodes the AV-over-IP signal from the camera(s) and originates a USB stream.



Status light – Provides basic information about the device.

- Illuminated: Normal operation.
- Off: No power to the device.
- Blinking: Error.

IP Address button – Press to display the decoder's IP address in its USB stream.

Dimensionally enhanced logo badge – We have spared no expense to provide a puffy logo badge to elevate your experience. It's quite shiny, and offers superior tactile appeal.

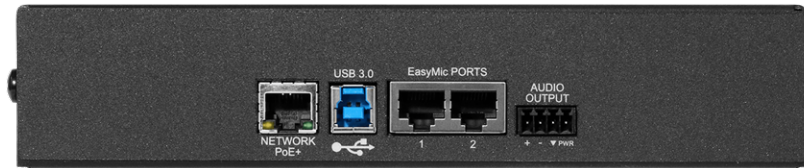

- **Network/PoE+** – RJ-45 connector. Connect to a powered port on the PoE+ switch.
- **USB 3.0** – USB Type B connector. Connect to a computer for use with soft conferencing applications. Provides uncompressed USB 3.0 stream.
- **EasyMic** – RJ-45 connectors. Connect to a TableMIC or other microphone with EasyMic connectivity.
- **Audio output** – Line level differential audio and 12 VDC power output to the optional amplified speaker or other audio infrastructure.

EasyIP Mixer

Ideal for large classrooms and multi-camera applications, the EasyIP Mixer pairs to Dante audio inputs and outputs, and manages up to four Vaddio EasyIP cameras. It's the Art of Easy in a production switcher.



- **Swap button** – Changes the selected input. If the PIP is turned on, this also exchanges the PIP and main image on the HDMI output.
- **PIP button** – Toggles the PIP on or off. Illuminated when the PIP is on.
- **Stream button** – Toggles HDMI and USB stream on or off. Illuminated when the stream is available.
- **IP button** – Toggles the IP address display. Illuminated when the streams are displaying the IP address instead of video.
- **Reset button** and power/status light – Illuminated when the device has power. Blinks to indicate an error condition. Press the button to reboot the device.
- **Dimensionally enhanced logo badge** – We have spared no expense to provide a lovely, dimensionally enhanced logo badge to elevate your visual experience. It's quite shiny. We hope you'll enjoy it.



- **Network/PoE** – Power, control via web interface, and Dante audio.
- **USB 3.0** – Uncompressed video output with PCM audio for conferencing applications.
- **RS-232** – Connect to an optional third-party control system.
- **Trigger** – Connect up to five trigger devices.
- **HDMI In** – Video (and audio, if available) from a connected camera or other HDMI source.
- **HDMI Out** - Output video (and audio, if available) from the selected input.
- **Audio In** Mic/Line In 1 and Mic/Line In 2 – Microphone or other audio inputs. Can be configured to supply phantom power.
- **Audio Out** Line Out 1 and Line Out 2 – Far-end audio from conferencing application or as configured in the audio matrix.

Installation

Please refer to the **Installation Guide for EasyIP AV-over-IP Systems** for a more system-oriented view of EasyIP product installation. It includes information not available in this manual.

This section covers:

- Selecting the location for the camera
- Installing the camera mount and mounting the camera
- Cabling notes
- Connection diagrams

And a required safety note here:

Note

PoE type networks connected to this equipment are for intra-building use only and should not be connected to lines that run outside of the building in which this product is located.

Don't Void Your Warranty!



Caution

When handling cameras, always support the camera's body when lifting or moving it. Lifting the camera by its head or mounting arm will damage it.

Caution

This product is for indoor use. Do not install it outdoors or in a humid environment without the appropriate protective enclosure. Do not allow it to come into contact with any liquid.

Caution

Do not install or operate this product if it has been dropped, damaged, or exposed to liquids. If any of these things happen, return it to Vaddio for safety and functional testing.

Before You Start

Work with the network administrator to plan your EasyIP deployment. A typical EasyIP system includes network equipment.

Do these things before installing any Vaddio product:

- Be sure you can identify all cables correctly.
- Check Cat-5 cables for continuity.
- Talk to the network administrator.
 - Inform the network administrator if you are installing the EasyIP system with a PoE+ switch. The Luxul switch sold as part of the EasyIPecosystem is configured for DHCP operation. The network administrator may need to take steps to ensure a trouble-free installation.
 - If you will be responsible for configuring the devices that you install, ask what hostnames (if any) you should assign to them.

Before Installing a Camera

Things to keep in mind when deciding where to install the camera:

- Consider camera viewing angles, lighting conditions, line-of-sight obstructions, and in-wall obstructions where the camera is to be mounted.
- Ensure that the camera body can move freely and will normally point away from the ceiling and lights. The camera will not perform well if it is pointed toward a light source such as a light fixture or window.
- If the remote will be used, ensure that nothing blocks the IR lens in the camera's base.

Cabling Notes

The TableMIC is shipped with one Cat-5e cable to connect it to your conferencing installation.

The CeilingMIC is shipped with one Cat-5e cable to connect it to the interface box.

Caution

When building cables for Vaddio products, do not use pass-through RJ-45 connectors. Incorrectly crimped pass-through connectors can damage the connectors on the product, which will void your warranty.



Intact – will make reliable contact with cable connector

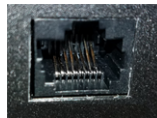

Damaged – Bent contact fingers will NOT make reliable contact with cable connector

Use Cat-5e or better cable. We recommend using high-quality connectors and a high-quality crimping tool. If connectors are crimped incorrectly, they can cause intermittent connections and degrade signal quality.



We recommend shielded cabling if the cables will be coiled, run tightly with other cables, or routed near sources of electromagnetic interference such as power lines or fluorescent light fixtures.

Caution

Check your cables. Connecting a cable to the wrong port or using the wrong pin-out can result in equipment damage and will void the warranty.

Pro Tip

Label all cables at both ends.

Basic Connections – EasyIP Decoder and EasyIP 10 Cameras

Here is an example of a simple EasyIP deployment. In this setup, an EasyIP Decoder manages up to four EasyIP 10 cameras and provides hard-wired audio connections. A PoE+ switch provides power and network connectivity to the EasyIP products. The EasyIP Decoder connects directly to a computer as a USB conferencing device.

Vaddio recommends making all connections while the PoE+ switch is turned off.

If no PoE+ switch is used, a mid-span PoE+ power injector (sold separately) is required for each EasyIP device.

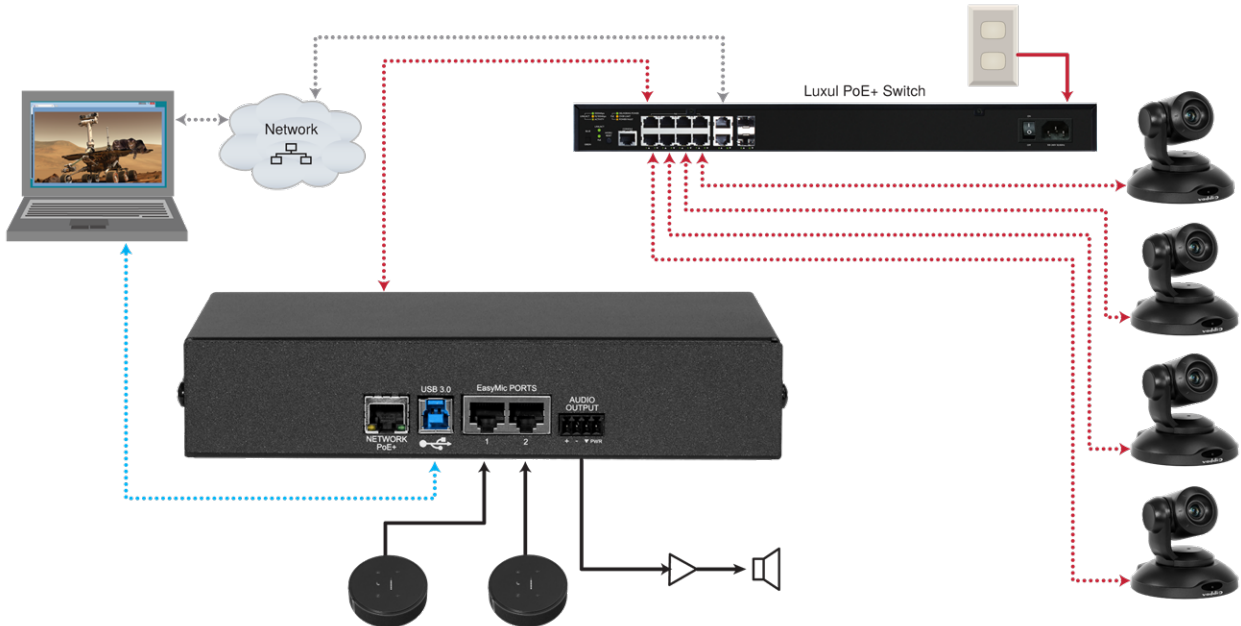

Note

EasyIP 10 cameras require an EasyIP Decoder or EasyIP Mixer to decode the AV-over-IP signal and originate a USB stream.

The EasyIP Decoder is compatible with EasyIP cameras only. It does not detect or pair with other types of cameras.

Caution

Do not connect the PoE+ switch to the network without guidance from an on-site network specialist.

Basic Connections – EasyIP Mixer

Here is an example of an EasyIP deployment using an EasyIP Mixer. In this setup, the EasyIP Mixer manages up to four EasyIP 10 cameras and provides hard-wired audio connections for speakers and microphones. The EasyIP Mixer can also pair to network-connected Dante speakers and microphones, managing up to four of each. A computer connects to the system as a USB conferencing device and HDMI content source. A PoE+ switch provides power and network connectivity to the EasyIP products. If no PoE+ switch is used, a mid-span PoE+ power injector (sold separately) is required for each EasyIP device.

A PoE+ switch provides power and network connectivity to the EasyIP products. If no PoE+ switch is used, a mid-span PoE+ power injector (sold separately) is required for each EasyIP device.

Vaddio recommends making all connections while the PoE+ switch is turned off.



Note

The EasyIP Mixer is compatible with EasyIP cameras only. It does not detect or pair with other types of cameras.

Caution

Do not connect the PoE+ switch to the network without guidance from an on-site network specialist.

Using Dante Devices with the EasyIP Mixer

The EasyIP Mixer is compatible with Dante audio products. These products connect to the EasyIP Mixer over the network.

To work with Dante devices, you will need to download and install the free Dante Controller application from Audinate Pty. Ltd.:

www.audinate.com/products/software/dante-controller

Things to know about Dante Controller:

- Dante Controller does not work over Wi-Fi or across subnets. Your computer must be on the same subnet as the Dante devices you need to work with.
- Device names and IP addresses shown in Dante Controller do not match the corresponding information shown in Vaddio devices' web interfaces.
- Dante Controller allows you to rename devices, so you can make their identifying labels match what's displayed in the Vaddio web interface.

Audinate provides information, training, and documentation for Dante technology on their website.

Installing the Wall Mount

The camera is shipped with a wall mount. Other mounting options are available as well. Contact us if you don't have the camera mount you need.

You can install the camera wall mount to a 2-gang wall box or directly to the drywall.

- If you mount it to drywall, use the wall anchors provided with the wall mount.
- If you mount it to a wall box, use the cover plate screws supplied with the wall box.

If you install the camera wall mount to drywall, use the wall anchors provided with the mount.

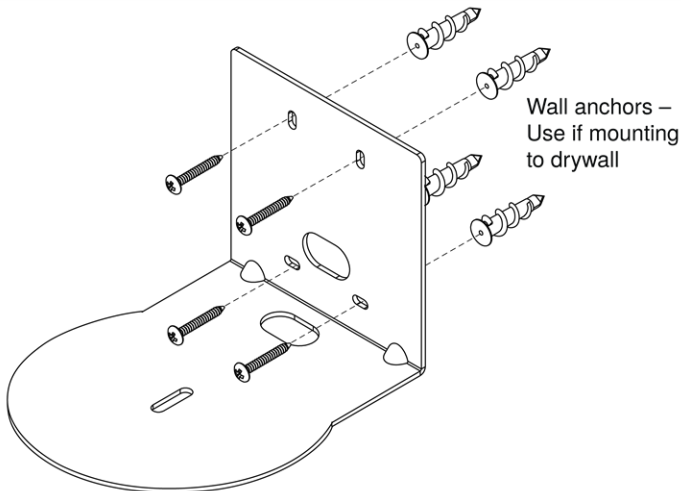

Your camera mount may look somewhat different.

About Ceiling-Mounted Cameras

If you use an inverted mount, set the camera's Image Flip mode ON for inverted operation. This orients the video image correctly and sets the tilt motors to respond appropriately to tilt up and down commands from the remote, web interface, and connected control devices. This control is available to the administrator on the web interface's System page. See [Inverting the Image for Ceiling-Mounted Cameras](#).

Installing the Camera

1. Route the cable through the opening in the mounting shelf and connect it to the camera.
2. Place the camera on the mount.

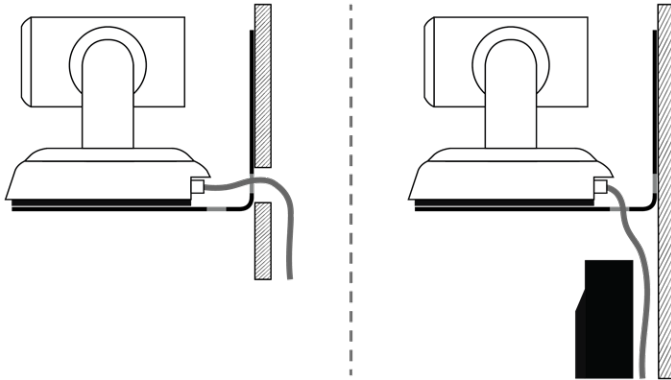
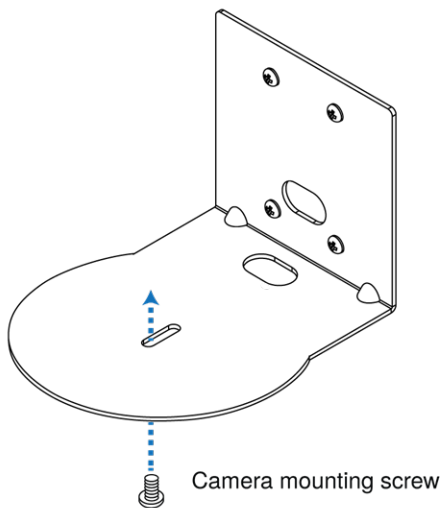

Image for illustration only; not to scale. Camera and mount details may differ.

3. Attach the camera to the mount using the mounting screw supplied with the camera.



Note

If the camera is jostled or bumped while it is connected to power, it may require a pan-tilt reset.

Powering Up the EasyIP System

Vaddio recommends making all connections while the PoE+ switch is turned off. To power the system, turn on the PoE+ switch.

- The EasyIP Decoder's status light turns blue when the device is ready. The connected computer recognizes it as a USB peripheral.
- The EasyIP 10 cameras initialize and move if they are powered from the same PoE+ switch. This will take a few seconds. When each camera's status light turns blue, the camera is ready to accept control information.
- The EasyIP Mixer's power light in the Reset button illuminates immediately when power is connected. The device's web interface is available after it finishes booting. This takes about 20 seconds.

Initial Set-Up and Access to Administrative Controls

Like other Vaddio products, EasyIP products have a web interface for initial device set-up, administrative control, and operation. After initial device set-up, the web interface provides password-protected pages for administrative access to tasks such as configuring network and security settings, customizing device behaviors, and installing firmware updates. The administrator can configure the operator's pages to be password-protected or not.

When any EasyIP product is shipped from the factory, no password is set and the administrative controls are not available. Initial device set-up includes setting the password for the `admin` account, and may include additional tasks.

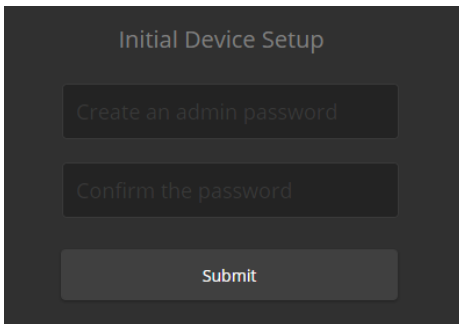

The image shows a screenshot of a web interface titled "Initial Device Setup". It features three input fields stacked vertically. The first field is labeled "Create an admin password", the second is labeled "Confirm the password", and the third is a "Submit" button. The interface has a dark, monochromatic color scheme.

Note

Because restoring factory defaults returns the product to a "like new" condition, you will need to do the initial device set-up again if you restore factory defaults.

After initial device set-up is complete, you will need to complete system administration tasks to define how each device behaves as an element of your network.

Browser Support

We have tested this product with these web browsers:

- Chrome®
- Firefox®
- Microsoft® Edge and Internet Explorer®
- Safari®

We test using the browser version available from the vendor at that time. Other browsers (including older versions of the ones on this list) are likely to work also.

Initial Device Set-up Process Overview

- **Use the Vaddio Deployment Tool** – Computer application. Use it to scan the subnet to locate Vaddio devices and identify those that have not been set up, then complete the initial device set-up and go to the device's web interface. The process is the same for all products.
- **Use the Vaddio Device Controller** – Dedicated web interface appliance. Use it to scan the subnet and locate Vaddio devices, then exit to the device's web interface to complete the initial device set-up. The process is the same for all products.
- **Cameras only: Use the EasyIP Decoder or EasyIP Mixer** to locate the camera and access its web interface. The process for locating the camera depends on the device you use to locate it. The rest of the product is the same as for other products.
- **Discover the IP address and navigate to the device manually** – The classic method. Discover the device's IP address and enter it in your browser's address bar to access the web interface. The way you discover the IP address depends on the device. The rest of the process is the same for all products.

The sequence of tasks for initial device set-up and system administration differs somewhat, depending on which of these methods you use.

About the Vaddio Device Controller

The Vaddio Device Controller is a stand-alone appliance for working with Vaddio products' web interfaces.

Ways the Vaddio Device Controller makes your tasks easier:

- Easily scan your network for Vaddio devices – no more complicated procedures for discovering devices' IP addresses.
- Following the scan, select a device and exit straight to its web interface.
- No annoying messages about HTTPS connections - you automatically connect via HTTPS.

About the Vaddio Deployment Tool

The Vaddio Deployment Tool simplifies provisioning and system administration for most Vaddio products, and provides a shortcut to each device's web interface. This tool is available as a free download at <https://info.legrandav.com/VaddioDeploymentTool>.

Ways the Vaddio Deployment Tool makes your tasks easier:

- Easily scan your network for Vaddio devices – no more complicated procedures for discovering devices' IP addresses.
- View scan results as a dashboard; easily identify unprovisioned and unauthenticated devices.
- Provision new devices or update device firmware from the dashboard.
- Import or export device configurations, reboot, or restore a device to factory defaults from its detail page.
- Access devices' web interfaces directly.
- Change a device's admin password from its detail page.
- Standby and mute controls available on the dashboard for authenticated devices.
- Organize Vaddio devices into groups – for example, by product type or physical location.

Access and Initial Device Set-Up Using the Vaddio Device Controller

The Vaddio Device Controller provides a shortcut to Vaddio products' web interfaces. Unlike the Vaddio Deployment Tool, it does not need to be updated to support new products.

To complete the initial device set-up with the Vaddio Device Controller:

1. Be sure the touch-panel is installed on the same subnet as the products you need to work with – for example, connect both to the same PoE+ switch.
2. Go to the touch-panel's Configuration page and select Scan. You will need to enter the Vaddio Device Controller's PIN to access the Configuration page.
3. Locate the device you need to work with, and select Use.
4. Select Exit to leave the Configuration page and open the device's web interface.

Note

The first time you access a device at a specific IP address, the screen may remain blank for 20 seconds or more.

5. Complete the initial set-up.

Initial Device Set-Up and Access Using the Vaddio Deployment Tool

As Vaddio introduces new products, we issue updates to the Vaddio Deployment Tool. Be sure you have the latest version of the tool, to ensure that it supports the products you are working with. This tool is available as a free download at <https://info.legrandav.com/VaddioDeploymentTool>.

To complete the initial device set-up with the Vaddio Deployment Tool:

1. Power up the EasyIP system if you have not done so already.
2. On the Find Devices page of the Vaddio Deployment Tool, click Scan. If the scan does not locate the EasyIP devices, click Advanced and specify the appropriate portion of the network to scan – your computer may be on a different subnet from the EasyIPEasyIP equipment.
3. In the list of equipment that the scan discovers, locate the EasyIP devices marked Not Set Up.

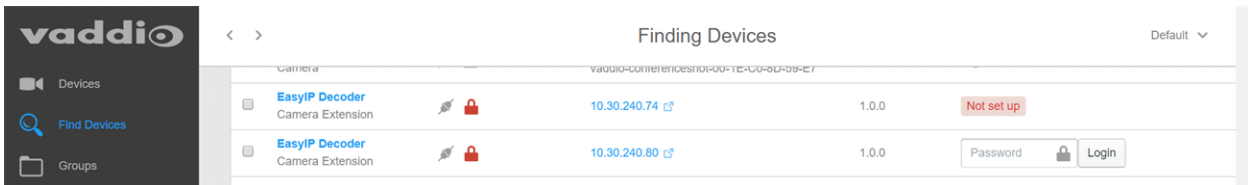

4. For each device, click the Not Set Up button. The device detail page opens.
5. Set the admin password. If there are other initial set-up tasks, they are also available here.

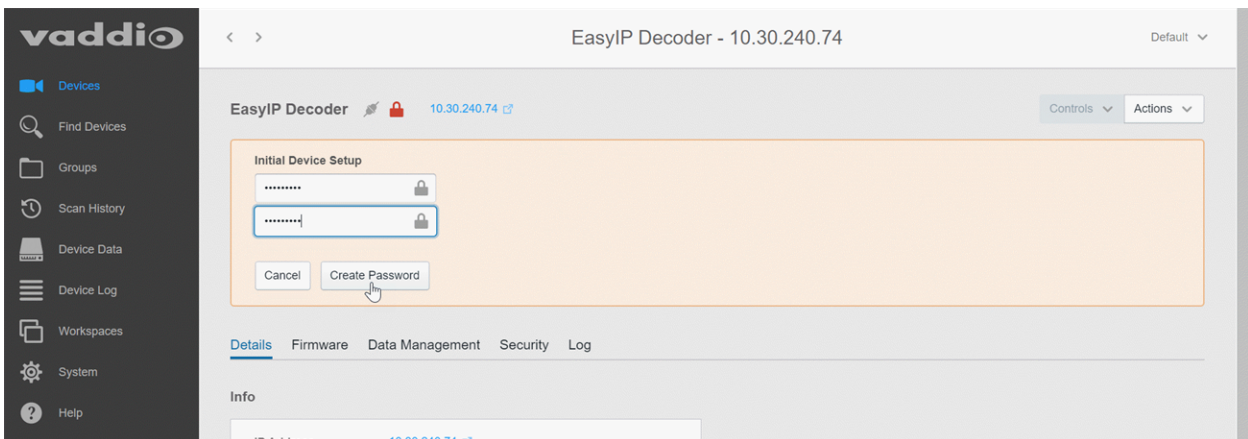

The device now shows up as unlocked.

Pro tip

On the Groups page of the Vaddio Deployment Tool, you can create a group containing only the EasyIP products.

To access EasyIP devices' web interfaces from the Vaddio Deployment Tool:

Select the device's IP address from any page where it appears. The Vaddio Deployment Tool logs you in to the web interface as `admin`.

Manual Access and Initial Device Set-Up

For EasyIP installations, you will need to start by completing the initial set-up for the device that manages the cameras. Then you can use the device to access the cameras' web interfaces.

For manual access and initial device set-up, the general process is:

1. Discover the device's IP address and access its web interface.
2. Complete the initial device set-up.
3. Complete the initial system administration tasks.

Initial Access to the Web Interface

Before the product is configured, HTTP access is disabled. **This is also true after restoring factory defaults.** The Vaddio Deployment Tool and the Vaddio Device Controller use HTTPS.

If you browse to the web interface manually, you may encounter this message:

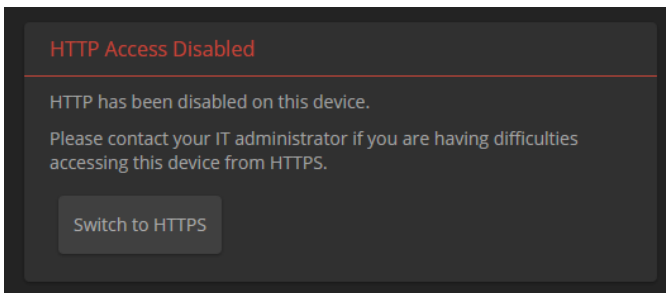

Switch to HTTPS if you see this message.

Expect a security warning from your browser the first time you access the device's web interface.

Different browsers will respond with different messages and options. Your browser will probably present a message indicating one of these things:

- The connection is not private
- The site is not secure
- The site is not trusted
- The site poses a security threat

This is because the certificate (the product's website security credential) is self-signed rather than being issued by an external certificate authority. *The HTTPS connection is secure and traffic is encrypted, however.*

To proceed to the product's web interface, **you will need to make the selections that your browser's security message discourages.** The security warning page may present an option to learn more, view details, or go to the "Advanced" page. When you select the applicable option, your browser provides a button or link to continue to the IP address you entered, with a statement that it may be unsafe. Select this option. *Your HTTPS connection is safe.*

After you have accessed the product's web interface once, your browser remembers its IP address and will not present the security message again.

Access the Web Interface of an EasyIP Decoder or EasyIP Mixer Manually

You will need to discover the device's IP address so that you can browse to it. For this, you need a laptop with a media player application to view the USB stream from the device.

To discover the device's IP address:

1. Connect the device's USB cable to your computer. Then power up the EasyIP system, if it is not already on.
2. Open a media player such as VLC Media Player and view the USB stream from the device. (If you use VLC Media Player, this is the "Open Capture Device" option under Media.) The EasyIP device is identified by its model name as an available capture device or video source.
The video output is blue or black until a camera or other video source is configured.
3. Press the button marked IP or IP Address. The device's IP and MAC addresses are displayed on the video output.
If video input is available when you press this button, it is replaced by the device's information on a blue background.
4. Press the button again to dismiss the information display.

To access the device's web interface:

Enter the IP address in your browser's address bar. See [Initial Access to the Web Interface](#) for information about the warning messages that you will encounter the first time you access the device's web interface.

Access the Web Interface of an EasyIP Camera Manually

After you have done the initial device set-up for the EasyIP Decoder or EasyIP Mixer, you will be able to use its web interface to locate and browse to your EasyIP cameras.

To discover a camera's IP address from an EasyIP Decoder:

1. Go to the Directory page.
2. If the system is already in service and cameras are paired to it, select their IP addresses to go directly to their web interfaces.
3. If the device does not yet have paired cameras, follow the instructions for [setting up the directory](#).

To discover a camera's IP address from an EasyIP Mixer:

1. Go to the Video Inputs page.
2. If the system is already in service and you need to discover a paired camera's IP address or access its web interface, select the appropriate EasyIP tab to display its information.
3. If the camera is not already paired to the device (for example, if you are in the process of doing initial set-up and system administration for a new installation), select an EasyIP tab.
4. Select Settings to open the pairing dialog.
5. Select Discover Devices.

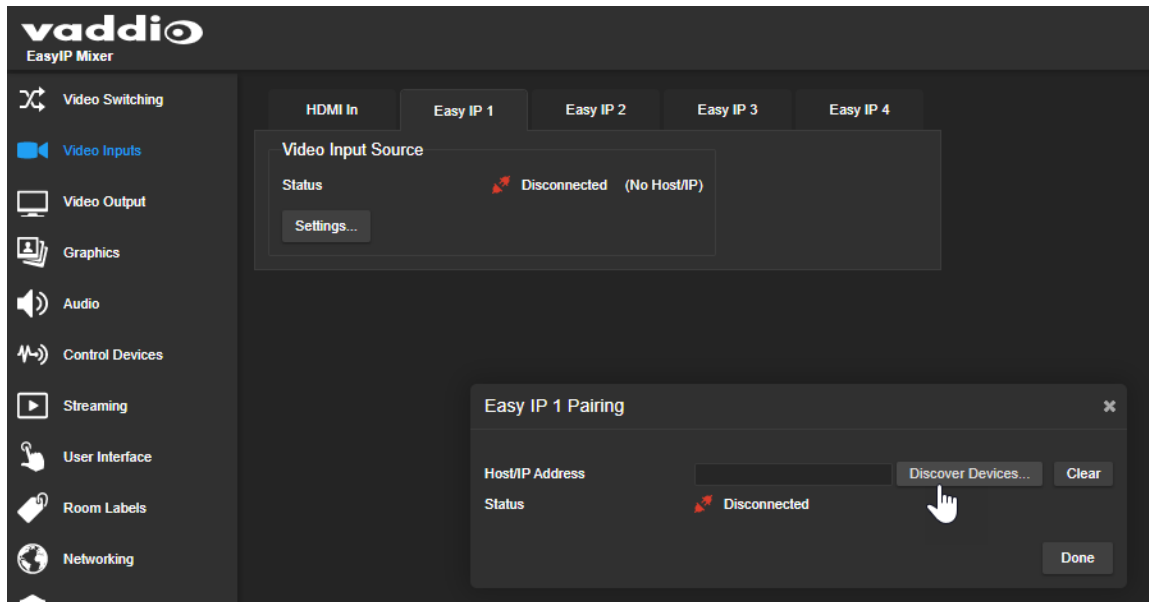

The web interface returns a list of EasyIP cameras on the EasyIP Mixer's subnet.

6. Select the camera's IP address to go directly to its web interface.

Next Steps for New Deployments

After initial device set-up is complete, you will also need to complete system administration tasks to define how each device behaves as an element of your network.

Security settings – In each device's administrative web interface, you can configure product security features to conform to the IT policies for your environment. See [Setting Passwords and Access](#).

Network settings – Depending on the requirements of your network, you may need to change the hostname. See [Changing the Hostname](#). If additional network changes are required, work with the site's network specialist to configure the Luxul switch.

Time zone – Set the device to the appropriate time zone to ensure that timestamps in the event log are accurate. See [Specifying Time Zone and NTP Server](#).

Room labels – Add helpful information such as the room location and phone number to the web interface of each device. See [Adding Room Information to the Device's Web Interface](#).

The system administration pages for these tasks are virtually identical for all EasyIP products.

Dante device identification – If your installation includes the EasyIP Mixer and you are using Dante-capable audio products with it, use the Dante Controller application to locate and optionally rename the Dante devices in your installation.

Web Interface Quick Reference

Where to find the controls you need right now for camera operation, administration, and configuration. If guest access is enabled, the web interface opens to the Controls page. You must log in as admin to gain access to the administrative pages.

EasyIP Decoder Basic Operation – Operator's Pages

The operator's pages (Home and Macros) do not require the admin login. Depending on how the system is configured, you may need to log in as **user**.

- Both pages provide access to mute, standby, video switching, and camera pan/tilt control functions.
- On the Home page, you can also control audio volume and work with camera presets.
- The Macros page provides access to any macros that are available.

EasyIP Mixer Basic Operation – Operator's Pages

The operator's pages (Home, Audio, and Macros) do not require the admin login. Depending on how the system is configured, you may need to log in as **user**.

- All operator pages provide access to mute, standby, video switching, and camera pan/tilt control functions.
- On the Home page, you can also work with keying, PIP, and camera presets.
- The Audio page provides volume and mute/unmute controls for selected audio inputs and outputs. The system administrator can change these if the defaults are not suitable for your environment.
- The Macros page provides access to any macros that are available.

Administrative Pages

Some of these tasks (such as network configuration) are common across devices; others (such as camera color adjustments) are specific to a single type of device within the installation.

Behaviors and operation

What do you need?	Go to this page
Camera operation	Camera (in the camera's web interface)
PIP	Video Switching or Video Output (EasyIP Mixer)
Graphics	Graphics (EasyIP Mixer)
UVC-Compliant or Client Custom USB streaming	System, DIP Switches tab (EasyIP Decoder or EasyIP Mixer)
Speaker and microphone settings	Audio (EasyIP Decoder or EasyIP Mixer)
Programmable behaviors	Control Devices (EasyIP Decoder or EasyIP Mixer)
USB and IP streaming settings	Streaming (EasyIP Decoder or EasyIP Mixer)

System administration

Configure these settings on each device.

What do you need?	Go to this page
Passwords and access management	Security
IP address, hostname, and other network settings	Networking
Settings related to date and time	Networking
Information about the device <ul style="list-style-type: none"> ■ Room location and phone number ■ Help desk phone number 	Room Labels

Maintenance and Troubleshooting

What do you need?	Go to this page
<ul style="list-style-type: none"> ■ Update firmware or view the current firmware version ■ Save (export) and restore (import) the device's configuration ■ Reboot or reset to factory defaults 	System: Firmware (each device)
Update microphone firmware	System: Peripherals (EasyIP Decoder or EasyIP Mixer)
Camera adjustment: Recalibrate pan and tilt motors	System : Firmware (camera)
Locate Vaddio Technical Support contact information	Help (any device)
View diagnostic logs	Diagnostics (each device)

System Administration

System administration tasks define how the device behaves on your network. Although you may change device passwords regularly, other system administration tasks are usually needed only when installing the equipment.

Administrative tasks are on these pages of the web interface, shown in the lower portion of the left navigation panel:

- Networking – Network configuration, time zone and NTP server
- Security – Passwords, guest access, other IT security-related settings
- Room Labels – Helpful information to display in the web interface

These pages are the same for virtually all Vaddio products, though the details on the System and Help pages are product-specific.

Setting Passwords and Access

EACH DEVICE – SECURITY PAGE

The Account Passwords and Web Server areas of the Security page provide basic security for the web interface:

- **Admin password** – Required for access to the admin pages of the web interface and for Telnet access to the device.
- **User password** – When set, allows password-protected, non-administrative access to the operator's web interface.
- **Guest access** – When enabled, allows non-administrative access to the operator's web interface without a password.
- **Expire idle sessions** – By default, the web interface automatically logs you out after 30 minutes of inactivity.

Caution

Be sure you have a way to remember passwords after changing them. If you are not using the Vaddio Deployment Tool to manage the EasyIP devices, there is no way to reset a forgotten password on the EasyIP 10 camera. In this situation, you may need to return the camera to the factory.

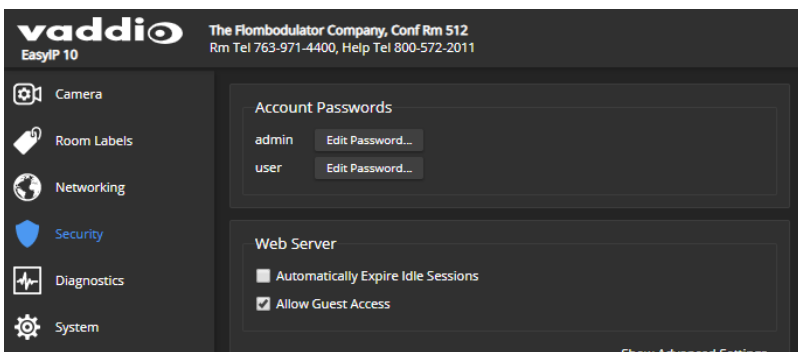
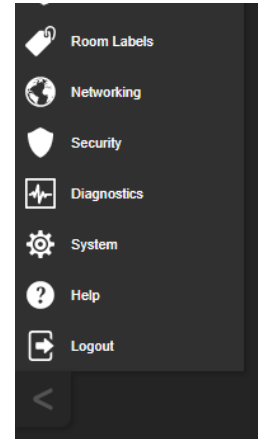

Configuring Other Security Settings

EACH DEVICE – SECURITY PAGE

Depending on your environment, you may want to make these changes:

- **Enable HTTP access** – When selected, administrators and operators can access the product’s web interface using the less-secure HTTP protocol.
- **Enable Telnet access** – When selected, the device accepts Telnet connections.

Default security-related settings:

- HTTP access is disabled
- Telnet access is disabled
- Device discovery is enabled

Note

Consult your network security specialist before changing any of these settings.

1. Select Show Advanced Settings. The advanced options open.

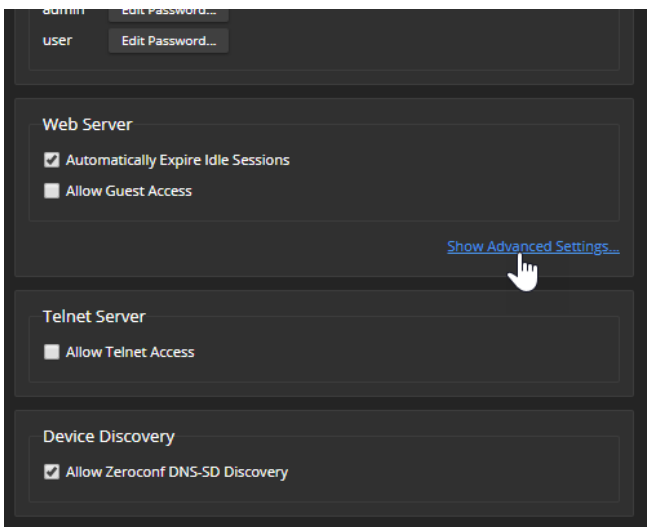

2. In consultation with your network security specialist, make the desired changes.

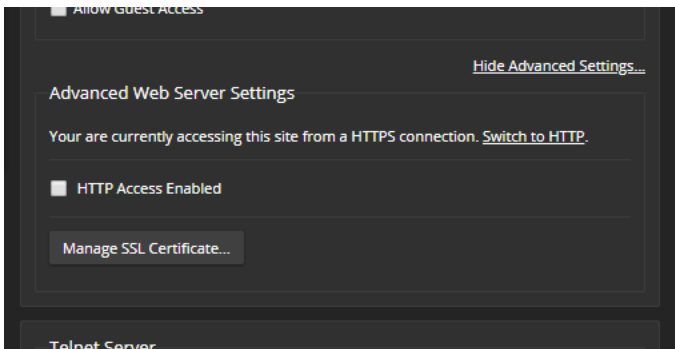

Changing the Hostname

EACH DEVICE – NETWORKING PAGE

Do not change network settings without guidance from an on-site network specialist.

If your network supports hostname resolution, you may find it convenient to change each device's hostname to something easy to remember. Work with your IT department to ensure that the new hostname conforms to the organization's naming conventions.

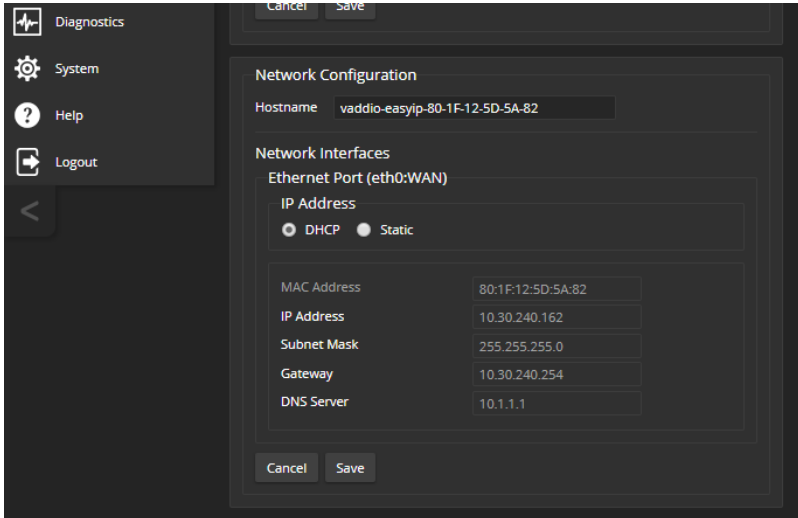

If additional network changes are required, work with the site's network specialist to configure the PoE+ switch. Refer to Luxul's manual for the switch.

Specifying Time Zone and NTP Server

EACH DEVICE – NETWORKING PAGE

Do not change network settings without guidance from an on-site network specialist.

Using automatic NTP updating ensures that the timestamps in the diagnostic log are accurate. Specifying your time zone may make it easier to match logged events with other actions and external events.

1. To make the time zone and NTP server editable, enable Automatic NTP Updating.
2. Select the desired time zone from the list.
3. If desired, specify the NTP server to use. If you are not sure about this, use the default.

You may need to refresh the system time display.

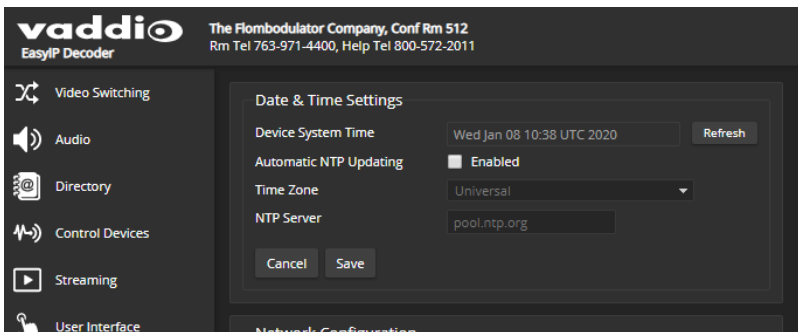

Adding Room Information to the Device's Web Interface

EACH DEVICE – ROOM LABELS PAGE

The information you enter on this page is displayed on every page of the device's web interface. You may also wish to specify what appears on the device's browser tab.

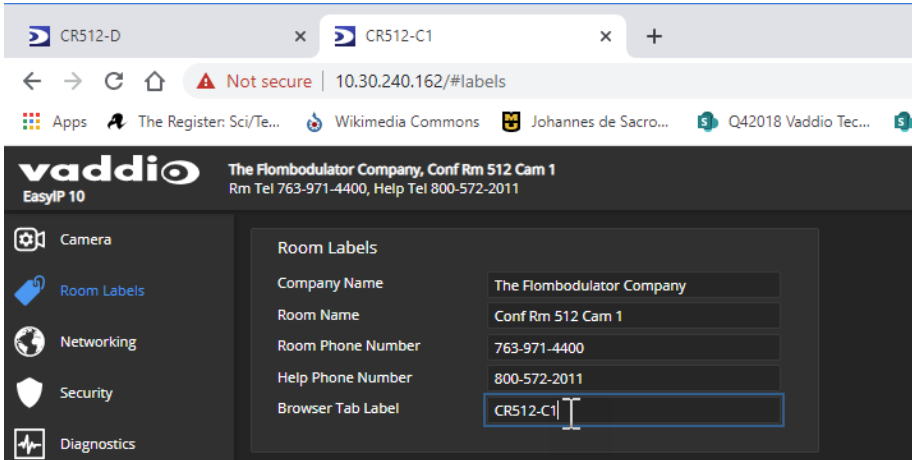

Configuring System Behavior

This chapter covers settings on the EasyIP Decoder and EasyIP Mixer for defining how the system performs in your environment. Some configuration tasks apply to just one of the devices covered in this manual; others apply to more than one. In some cases, the steps to complete a task depend on the device.

What's in this chapter:

- Locating and pairing to cameras
- Streaming settings
- Locating and pairing to Dante devices
- Audio settings and adjustments
- Video settings
- Graphics (EasyIP Mixer)
- Macros and triggers
- Other system behaviors

Camera settings are covered separately in the next chapter.

Locating and Pairing to Cameras on the Network – EasyIP Decoder

EASYIP DECODER – DIRECTORY PAGE

Cameras are paired to the EasyIP Decoder if they are in its directory.

Status indications tell you whether each camera is currently available.

- **Disconnected** – The camera is currently unavailable, or the input is not paired to a camera.
- **Unauthenticated** – A camera is paired, and is waiting for you to log in as admin from this device.
- **Connected** – A camera is paired, ready to send video and accept commands.

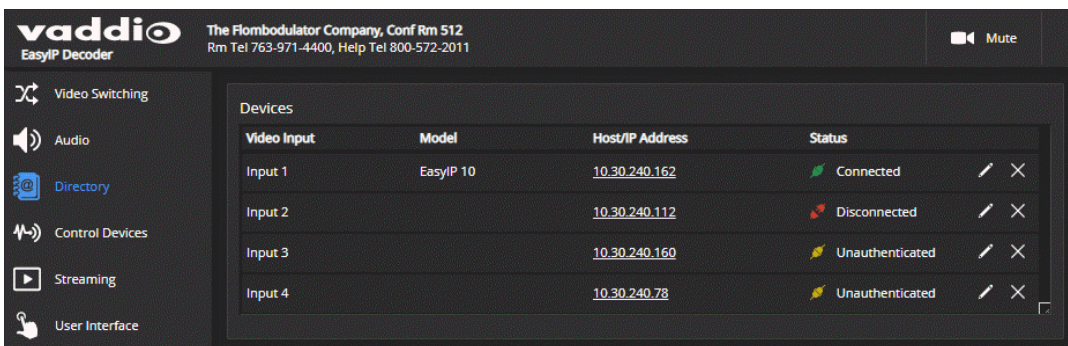

Locating and pairing to cameras works similarly on the EasyIP Mixer, but the web interface page structure is somewhat different.

To add a camera to the directory:

1. Select the Edit icon (pencil) for the input to pair. The Input Pairing dialog box opens.
2. To find the IP addresses of EasyIP cameras on the same subnet as the EasyIP Decoder, select Discover Devices. You can add a camera from another subnet by entering its hostname or IP address in the Host/IP Address box.

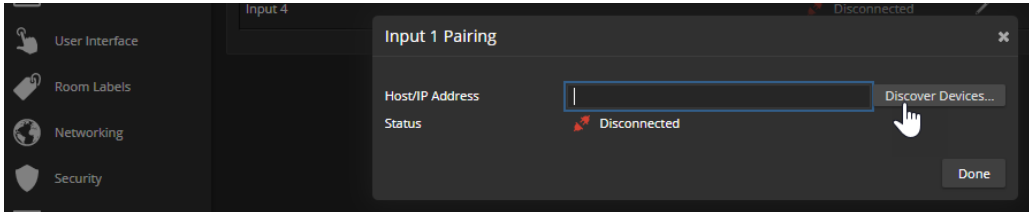

3. Select one of the cameras from the list, and select Done.

Note

If a camera is paired to two or more EasyIP devices, more than one person can control the camera at any given time. This can result in unexpected camera behavior.

4. Authenticate to the selected camera. After you submit the correct admin password for the camera, the Input Pairing box shows its status as Connected.

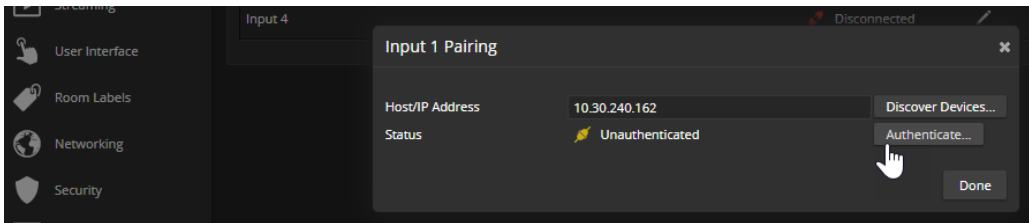

5. Select Done to save the pairing and return to the main Directory view.
6. If you were not able to authenticate to the camera, select its IP address from the Pairing box to open its web interface in a separate browser tab, and complete the initial device set-up. Then authenticate to the camera.

To change a directory entry:

Select the pencil (edit) icon for the desired address book entry to edit its IP address or name.

Select the X icon to delete the address book entry.

To access a camera's web interface:

Select the hostname/IP address of the desired camera. Its web interface opens in a separate browser tab.

Locating and Pairing to Cameras on the Network – EasyIP Mixer

EASYIP MIXER – VIDEO INPUTS PAGE

Cameras are paired to the EasyIP Mixer if the EasyIP input buttons on the Video Switching page are active. The cameras' information appears in the EasyIP Input tabs of the Video Inputs page.

Status indications tell you whether each camera is currently available.

- **Disconnected** – The camera is currently unavailable, or the input is not paired to a camera.
- **Unauthenticated** – A camera is paired, and is waiting for you to log in as admin from this device.
- **Connected** – A camera is paired, ready to send video and accept commands.

Locating and pairing to cameras works similarly on the EasyIP Decoder, but the web interface page structure is somewhat different.

To locate cameras on the network:

1. Select an EasyIP input tab. Then select Settings to open the Pairing box.

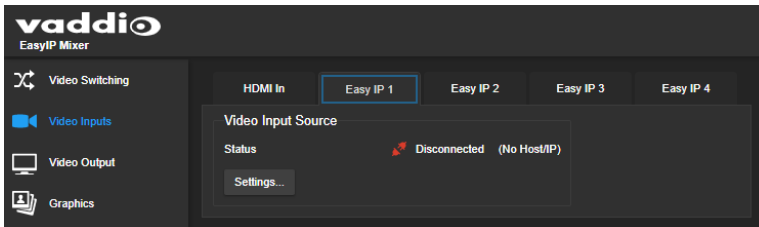

2. To find the IP addresses of EasyIP cameras on the same subnet as the EasyIP Decoder, select Discover Devices. You can add a camera from another subnet by entering its hostname or IP address in the Host/IP Address box.

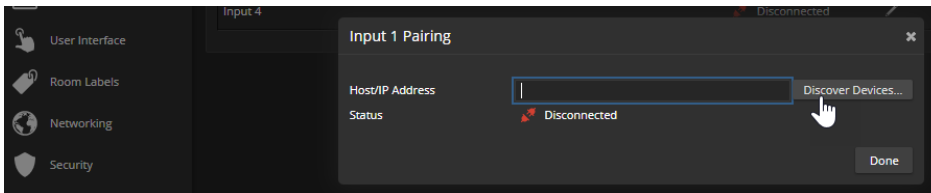

3. Select one of the cameras from the list, and select Done.

Note

If a camera is paired to two or more EasyIP devices, more than one person can control the camera at any given time. This can result in unexpected camera behavior.

4. Authenticate to the selected camera. If this is not successful, select the camera's IP address to open its web interface in a separate browser tab, and complete the initial device set-up. Then authenticate to the camera.

After you submit the correct admin password for the camera, its status shows as Connected. Select Done to save the pairing.

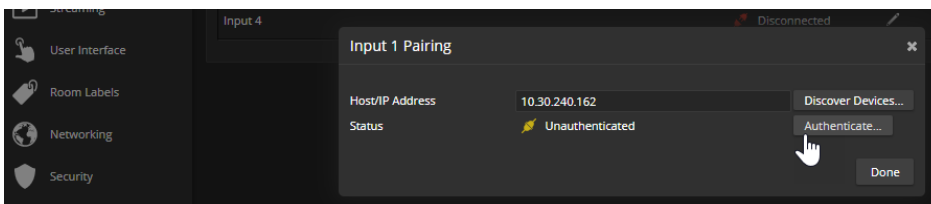

To access a camera's web interface:

Select the hostname/IP address of the desired camera. Its web interface opens in a separate browser tab.

Configuring Streaming Behavior

The EasyIP Decoder and EasyIP Mixer convert video from the selected input to a USB stream, which can be viewed using the computer connected to the system.

Viewing a Stream

To view the USB stream:

Connect your computer to the USB port on the EasyIP Decoder or EasyIP Mixer, and do one of these things:

- Start or join a conference.
- Open a stream viewer and select the EasyIP Decoder or EasyIP Mixer as the video capture device.

The device streams video from the currently selected video input.

Configuring USB Streaming

STREAMING PAGE

These settings affect how the EasyIP system works with soft conferencing applications.

To change the way the EasyIP Decoder or EasyIP Mixer shows up in your soft client's camera selection list:

Edit the USB Device Name.

To allow conferencing applications to control the audio:

Check the Enabled box for HID Audio Controls.

To allow conferencing applications to control the camera:

Check the box marked Enable UVC Extensions.

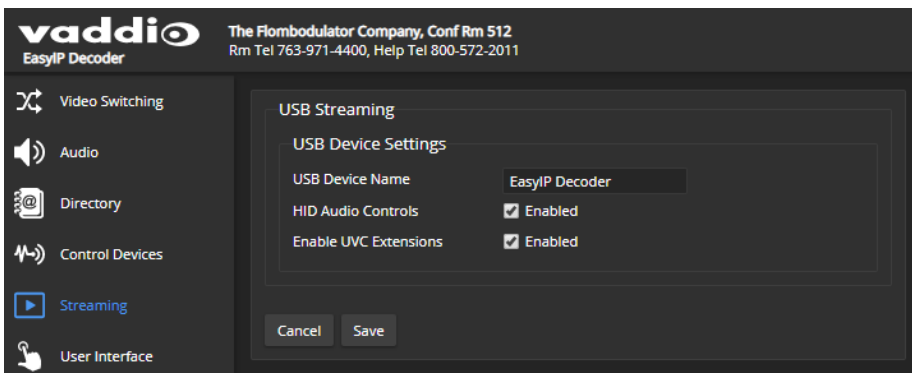

Configuring the USB Stream Format for Specific Applications

SYSTEM PAGE

Depending on the conferencing application that you use, you may need to change the USB stream format. The Client Custom enables far-end camera control when used with the Zoom soft client. Use the default UVC Compliant setting with most other conferencing applications.

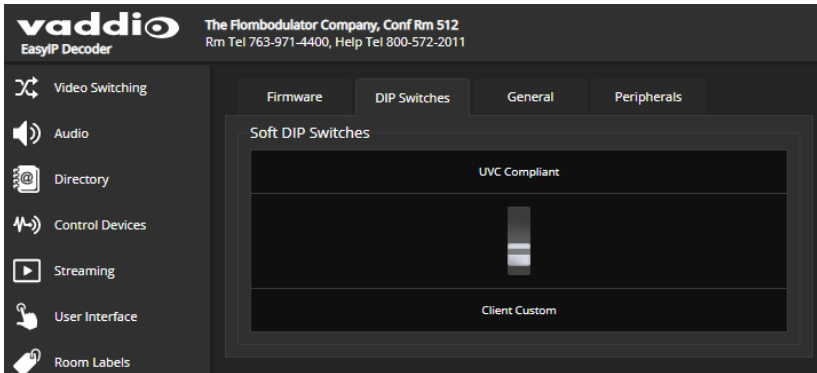

Locating and Pairing to Dante Devices

DANTE CONTROLLER APPLICATION

To work with Dante devices, you will need to download and install the free Dante Controller application from Audinate Pty. Ltd.:

www.audinate.com/products/software/dante-controller

Use the Dante Controller application to identify the Dante devices on your subnet, pair them, and optionally rename them.

Notes

The Dante chip in the EasyIP Mixer has its own IP address and device name. These do not correspond to the EasyIP Mixer's hostname and IP address in the web interface.

The screen shots in this section show a different product, "AVB2x1." The process for locating the EasyIP Mixer and pairing it to Dante speakers and microphones is the same.

To physically locate Dante devices using the Dante Controller application:

1. Open the Device Info tab to see the IP address and other information about each Dante device on the subnet that your computer is on.

2. From the main Network View, select Device : Device View. The Device View window opens.

Note that EasyIP Mixer devices will show the IP address of the Dante chip, not device's web server IP address.

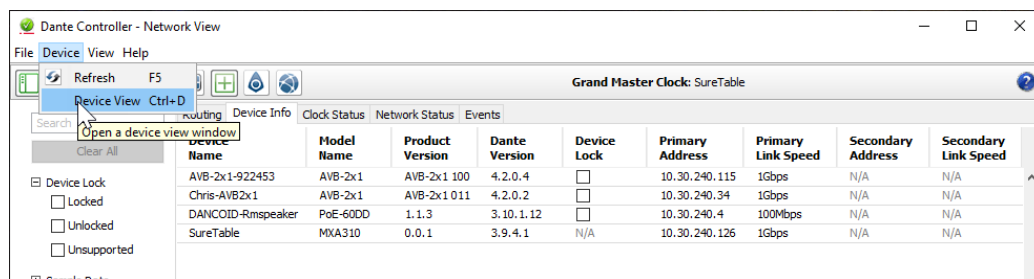

3. In the Device View window, select the device of interest. The window presents information about the device.

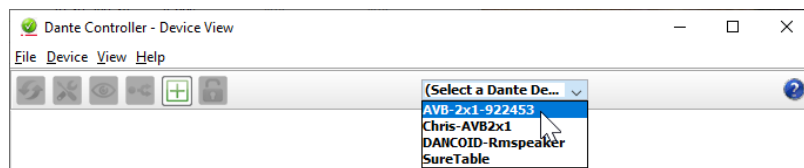

4. Select the Identify icon. The way the device responds depends on the device. The EasyIP Mixer responds by blinking all the lights on the front panel. To stop the identifying behavior, select the Identify icon again.

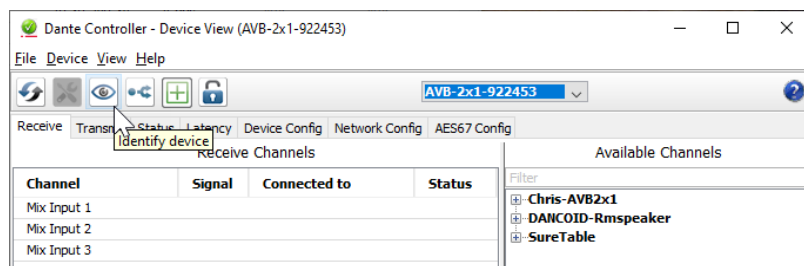

To pair Dante audio devices to the EasyIP Mixer:

1. From the main Network View, select Routing.
2. Use the matrix to pair receivers (speakers) and transmitters (microphones) to the EasyIP Mixer, which is both a receiver and a transmitter.

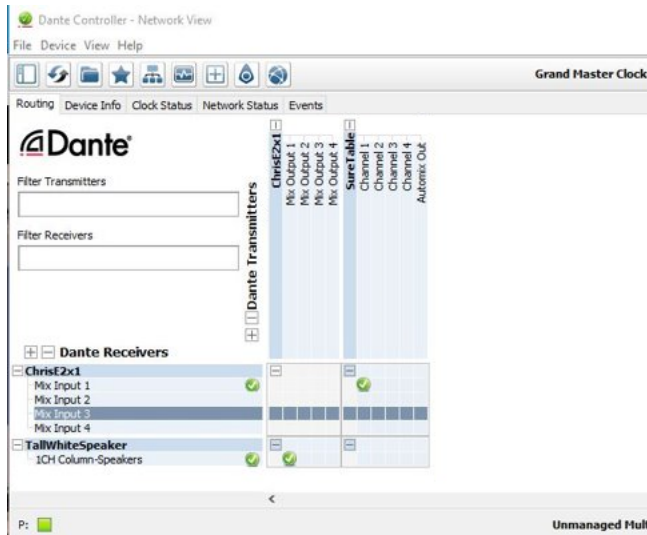

In this screen shot, the receiver "TallWhiteSpeaker" is routed to Dante output 1 of the device "ChrisE2x1". The transmitter "SureTable" (a tabletop microphone) is routed to the device's Dante input 1.

To rename a device in the Dante Controller application:

In the Device View window, select the device and go to its Device Config tab. The Rename Device option is near the top of the tab.

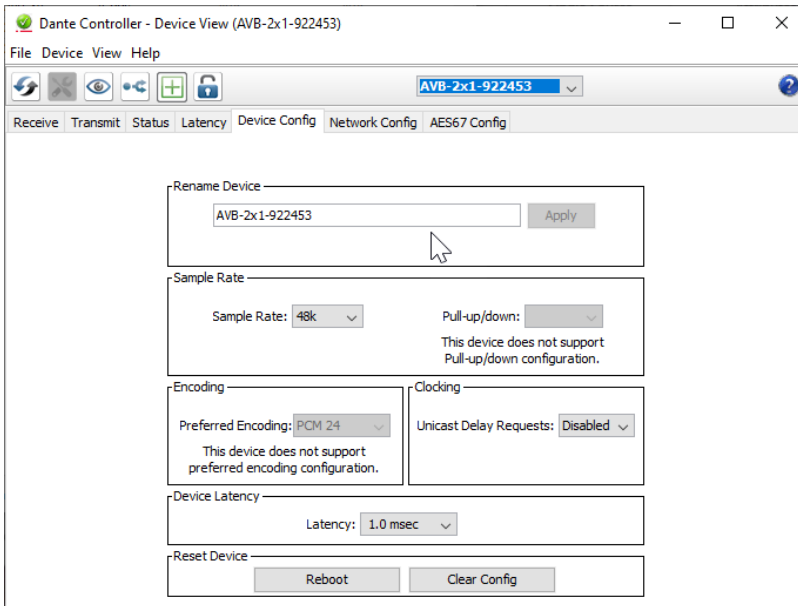

Configuring Audio Settings

EASYIP DECODER – AUDIO PAGE, INPUTS AND OUTPUTS TABS

EASYIP MIXER – AUDIO PAGE, MULTIPLE TABS

The web interface provides separate controls for each of the audio inputs and outputs. The EasyIP Decoder provides simple input and output controls; the EasyIP Mixer provides the sophisticated controls of a pro A/V solution.

Some of the settings are the same for both products. Others are only available on the EasyIP Mixer.

The EasyIP Decoder presents audio controls on two tabs – **Inputs** and **Outputs**.

The EasyIP Mixer groups the controls according to the signal type, and provides an audio matrix for routing inputs to outputs. Audio tabs are:

- **Analog** – Line/Mic inputs 1 and 2 (typically the room's microphones) ; audio line out 1 and 2 (typically the room's speakers).
- **Dante** – Up to four network-connected microphones or other audio inputs, and up to four speakers or other audio outputs. Use the Dante Controller application to pair Dante devices to the EasyIP Mixer.
- **HDMI** – Left and right audio channels from the HDMI input device, and left and right audio channels to the HDMI output.
- **Streaming** – Left and right audio channels for USB Playback (far-end audio) and USB Record (near-end audio).
- **Matrix** – Defines the source (vertical axis) for each audio output (horizontal axis). Note that USB playback cannot be the source for USB record.

Muting All Audio Inputs Together

EASYIP DECODER – ALL PAGES

EASYIP MIXER – ALL PAGES

Use the audio mute button at the top of any page of the web interface. This control is present in the admin interface and the operator's interface.

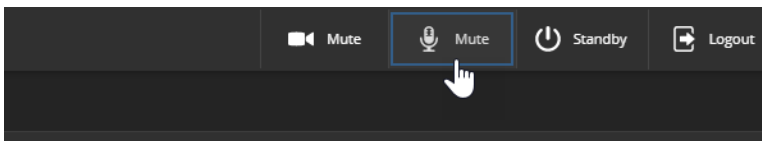

Muting and Controlling Volume Per Input or Output

EASYIP DECODER – AUDIO PAGE, BOTH TABS

EASYIP MIXER – AUDIO PAGE, ALL TABS EXCEPT MATRIX

To manage individual audio inputs or outputs:

Use the slider for the appropriate audio input or output to set the volume. The audio level meter and numeric value can be helpful.

Note

For best performance with most computers, we recommend setting the USB Record volume high.

Note

Because Dante audio components connect to the network, unexpected behavior can occur. This can be disruptive if the affected component is a speaker. Vaddio recommends muting Dante speakers or turning down their volume to the minimum setting when they are not in use.

To mute individual inputs or outputs:

Use the button to mute the desired audio input or output.

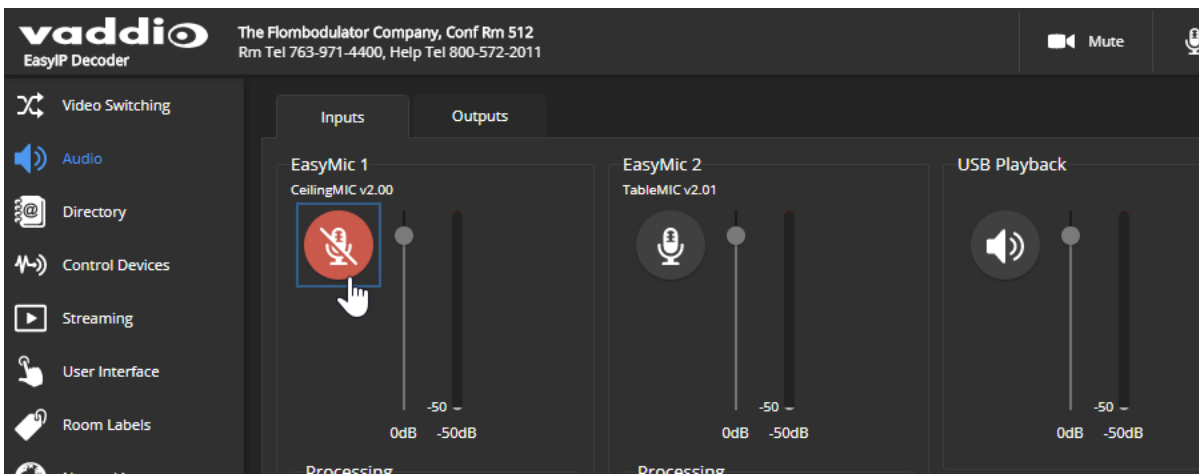

Enabling Phantom Power to Microphones – EasyIP Mixer

AUDIO PAGE, ANALOG TAB

To supply 48 VDC phantom power to a microphone connected to a Line/Mic input, check the Phantom Power checkbox below the controls for the appropriate input.

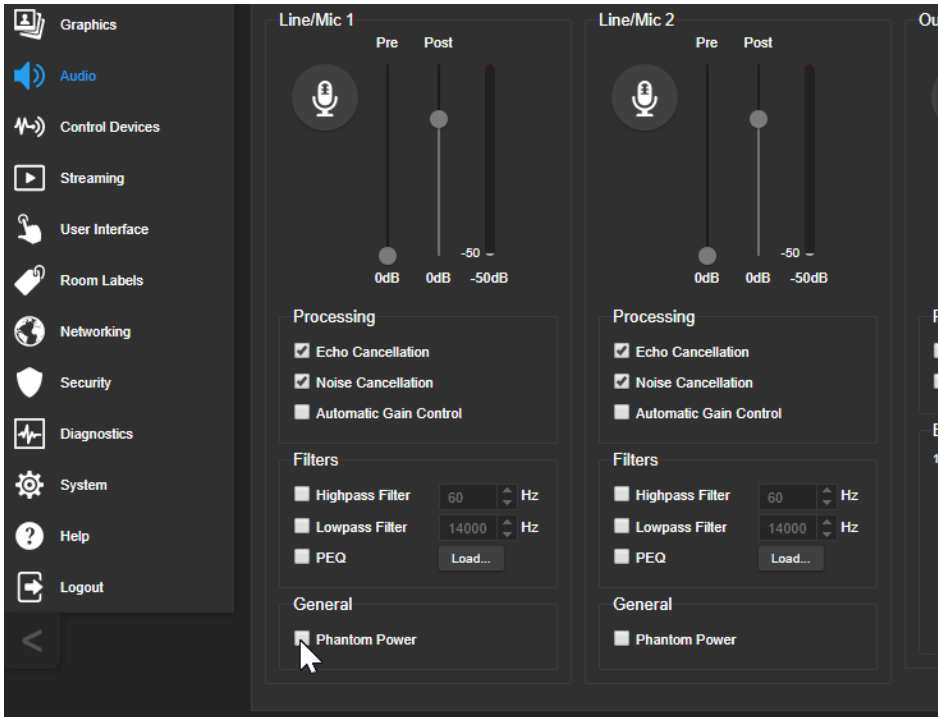

About Echo Cancellation

When a microphone picks up the audio from a speaker (far-end audio) during a conference, it sends the far-end audio back to the participants at the far end, creating an echo. Acoustic echo cancellation prevents this.

Here's how it works:

1. The speaker feeds the far-end audio into the room. This signal also goes to the audio processor as the reference that needs to be canceled.
2. The audio processor inverts the signal and sends it to the microphone.
3. The sum of the audio that the microphone picks up from the speaker and the inverted signal is 0: The echo is canceled.

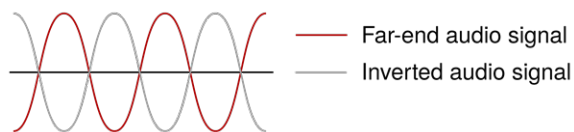

With the audio from the speaker canceled out, the audio from the microphone includes only the sounds originating at your end of the conference.

The EasyIP Mixer can use any of its audio outputs as the signal reference for acoustic echo cancellation. Select the AEC Reference at the top of the Analog or Matrix tab of the Audio page.

Fine-Tuning Microphone Performance – EasyIP Decoder

AUDIO PAGE, INPUTS TAB

To adjust microphones for best far-end audio performance:

Check or clear the checkboxes for the desired adjustments:

- **Echo Cancellation** – Keeps microphones from feeding the speaker output back into the system. Under most circumstances, echo cancellation is desirable.
- **Noise Cancellation** – Suppresses ambient noise such as the conference room's heating/air conditioning.
- **Automatic Gain Control** – Adjusts gain to compensate for differences in the volume of people's voices.
- **Mic Boost** – Provides a 3 dB boost.

EasyPEQ filtering offers additional options.

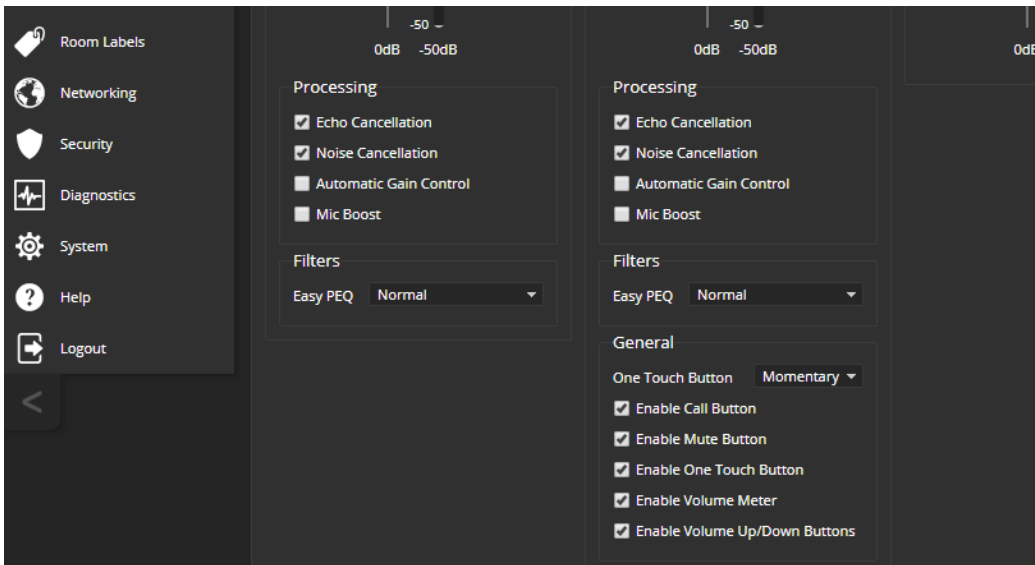

You may need to adjust the microphones to suit the room or the specific conference.

To correct this...	Do this
Reverberant room	From the Easy PEQ menu, select Reverberant Room.
Noisy environment	From the Easy PEQ menu, select Ambient Noise to reduce gain in the frequencies above and below the normal speech range.
Participants who have quiet voices or are seated beyond the microphones' optimum pick-up range	Select the Mic Boost processing option to increase microphone gain overall. From the Easy PEQ menu, select Speech Enhancement to increase gain in the frequency range for speech.
Participants with widely differing vocal volumes	Select the Automatic Gain Control processing option to adjust microphone gain based on the relative volumes of people's voices.

If two microphones are connected, they do not necessarily need to be set the same way – for example, one microphone might be set to use Mic Boost while the other is not.

Fine-Tuning Microphone Performance – EasyIP Mixer

AUDIO PAGE, ANALOG AND MATRIX TABS

Presentation adjustments

To accomplish this...	Do this
Help people to hear the person who is speaking.	Enable Speech Lift and select the microphone closest to the person who is speaking. The signal from the selected microphone goes to the speakers in the room. (Analog and Matrix tabs)
Automatically adjust for differences in volume as different people speak	Enable Automatic Gain Control for the appropriate microphone. (Analog tab only)
Specify microphone priority when more than one person is speaking.	Enable Chairman Override and select the microphone that has priority. (Matrix tab only)

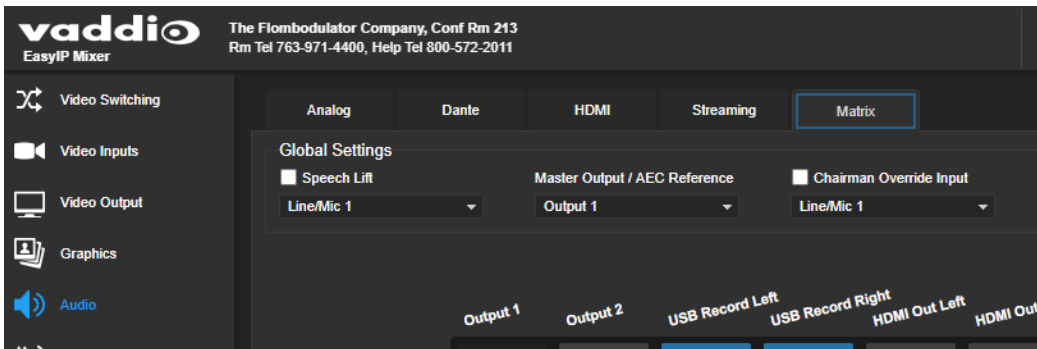

Performance adjustments

To accomplish this...	Do this
Specify which audio output to use as the reference for acoustic echo cancellation.	Select a Master Output/AEC Reference . (Analog and Matrix tabs)
Reduce hissing sounds that microphones pick up.	Enable Lowpass Filter and specify the highest frequency for the microphone to pick up. (Analog tab, per microphone)
Reduce low-frequency background noise (such as heating/air conditioning systems) that the microphones pick up.	Enable Highpass Filter and specify the lowest frequency for the microphone to pick up. (Analog tab, per microphone)
Adjust the volume of specific frequency ranges to compensate for specific audio challenges.	Enable PEQ (parametric equalizer) and select Load to open the PEQ Filter window for the specified microphone. (Analog tab, per microphone)

Note

Use the equalizer to attenuate undesirable frequency ranges, not to boost the desirable frequencies.

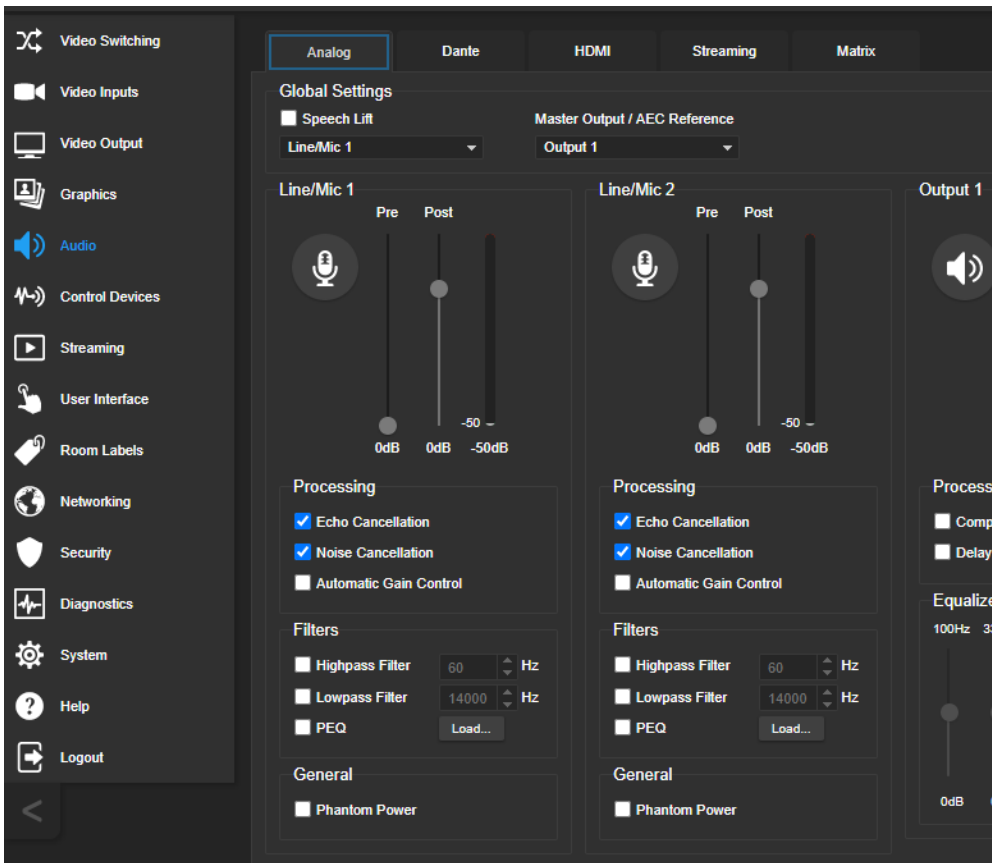

Fine-Tuning Speaker Performance – EasyIP Decoder

AUDIO PAGE, OUTPUTS TAB

To reduce the dynamic range from the connected speaker:

If some people on the far end are inaudible while others are too loud, check the Compressor box.

To adjust for more natural sound:

Use the equalizer to adjust specific frequency ranges.

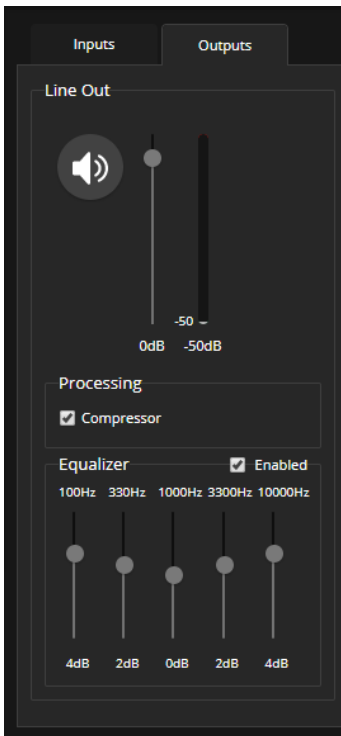

Fine-Tuning Speaker Performance – EasyIP Mixer

AUDIO PAGE, ANALOG TAB

Adjust each speaker as needed.

To accomplish this...	Do this
Compensate for differing speech volumes on the far end.	Select Compressor to reduce the dynamic range from the connected speakers.
Compensate for specific audio issues on the far end.	Use the equalizer settings for the analog outputs to attenuate specific frequency ranges. This can help if the far-end audio includes unwanted elements such as a rumbling HVAC system or a cricket in the room.

Note

Use the equalizer to attenuate undesirable frequency ranges, not to boost the desirable frequencies.

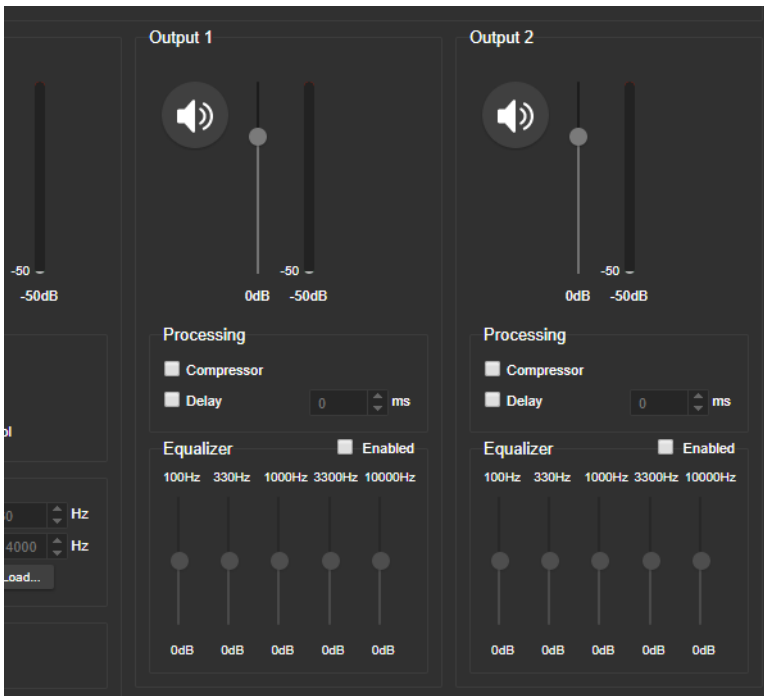

Synchronizing Audio with Video in the USB Stream – EasyIP Mixer

AUDIO PAGE, STREAMING AND ANALOG TABS

If the video lags noticeably behind the audio in the USB stream, check the Delay box for the appropriate channel and enter a delay value in milliseconds. Right and left channels may require different delay settings.

Delay can also be set for each analog output.

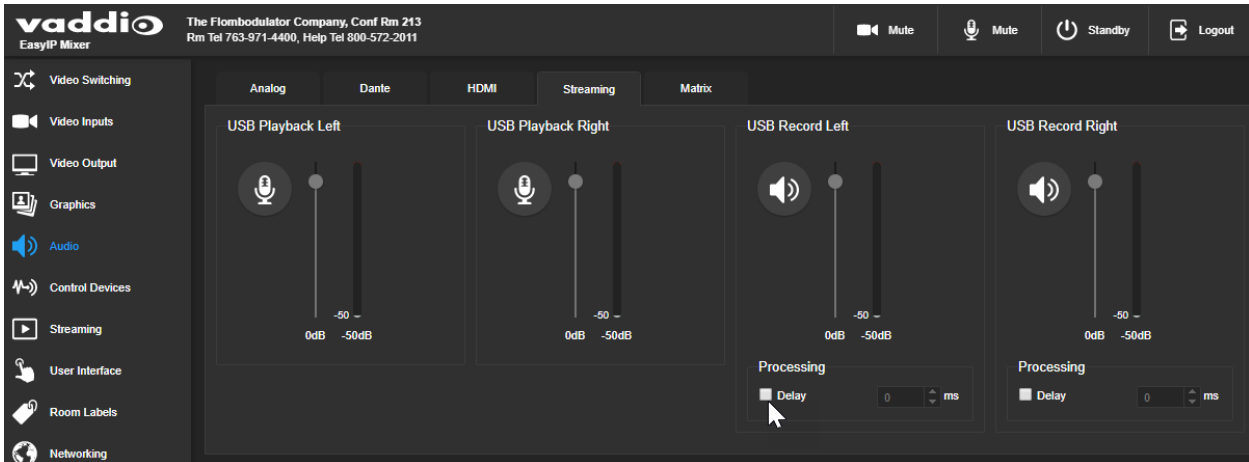

This setting is not available for the EasyIP Decoder.

Routing Audio – EasyIP Mixer

AUDIO PAGE, MATRIX TAB

The audio matrix defines where each audio output originates. Each column of the matrix shows one audio output, and each row shows one audio input. Table cells highlighted in blue mean that the input represented in that row is routed to the output represented in that column.

To specify how the EasyIP Mixer uses a given audio input:

Locate the row representing the audio input, and the column representing the desired output. Select the table cell where the desired row and column intersect.

Example: In the screen shot below,

- The auto mic mixer feeds near-end audio into the USB stream.
- All available audio inputs go to the auto mic mixer.
- The left and right USB playback channels (far-end audio) feed into Output 1 (a speaker) and all the available Dante speakers. Left and right channels are separate for the HDMI output, so the HDMI audio is in stereo. Output 2 is not used.

vaddio The Flombodulator Company, Conf Rm 213
EasyIP Mixer Rm Tel 763-971-4400, Help Tel 800-572-2011

Mute Mute Standby Logout

Video Switching Video Inputs Video Output Graphics Audio Control Devices Streaming User Interface Room Labels Networking Security Diagnostics System Help Logout

Global Settings
 Speech Lift Master Output / AEC Reference Chairman Override Input
 Line/Mic 1 Output 1 Line/Mic 1

	Output 1	Output 2	USB Record Left	USB Record Right	HDMI Out Left	HDMI Out Right	Dante Out 1	Dante Out 2	Dante Out 3	Dante Out 4
Auto Mic Mixer	On 0db	Off 0db	On 0db	On 0db	Off 0db	Off 0db	Off 0db	Off 0db	Off 0db	Off 0db
Line/Mic 1	Off 0db	Off 0db	Off 0db	Off 0db	Off 0db	Off 0db	Off 0db	Off 0db	Off 0db	Off 0db
Line/Mic 2	Off 0db	Off 0db	Off 0db	Off 0db	Off 0db	Off 0db	Off 0db	Off 0db	Off 0db	Off 0db
HDMI In Left	Off 0db	Off 0db	Off 0db	Off 0db	Off 0db	Off 0db	Off 0db	Off 0db	Off 0db	Off 0db
HDMI In Right	Off 0db	Off 0db	Off 0db	Off 0db	Off 0db	Off 0db	Off 0db	Off 0db	Off 0db	Off 0db
USB Playback Left	On -6db	Off 0db			On 0db	Off 0db	On -3db	On -3db	On -3db	On -3db
USB Playback Right	On -6db	Off 0db			Off 0db	On 0db	On -3db	On -3db	On -3db	On -3db
Dante In 1	Off 0db	Off 0db	Off 0db	Off 0db	Off 0db	Off 0db	Off 0db	Off 0db	Off 0db	Off 0db
Dante In 2	Off 0db	Off 0db	Off 0db	Off 0db	Off 0db	Off 0db	Off 0db	Off 0db	Off 0db	Off 0db
Dante In 3	Off 0db	Off 0db	Off 0db	Off 0db	Off 0db	Off 0db	Off 0db	Off 0db	Off 0db	Off 0db
Dante In 4	Off 0db	Off 0db	Off 0db	Off 0db	Off 0db	Off 0db	Off 0db	Off 0db	Off 0db	Off 0db

Auto Mic Mixer
 Line/Mic 1
 Line/Mic 2
 HDMI In Left
 Dante In 1
 Dante In 2
 Dante In 3
 Dante In 4

Legend
 In Auto Mic Mixer
 Enabled
 Disabled
 Unavailable
 Speech Lift

To set the gain between input and output (crosspoint gain)

To adjust crosspoint gain between any input and the output to which it is routed, right-click the table cell in the matrix to open a gain control.

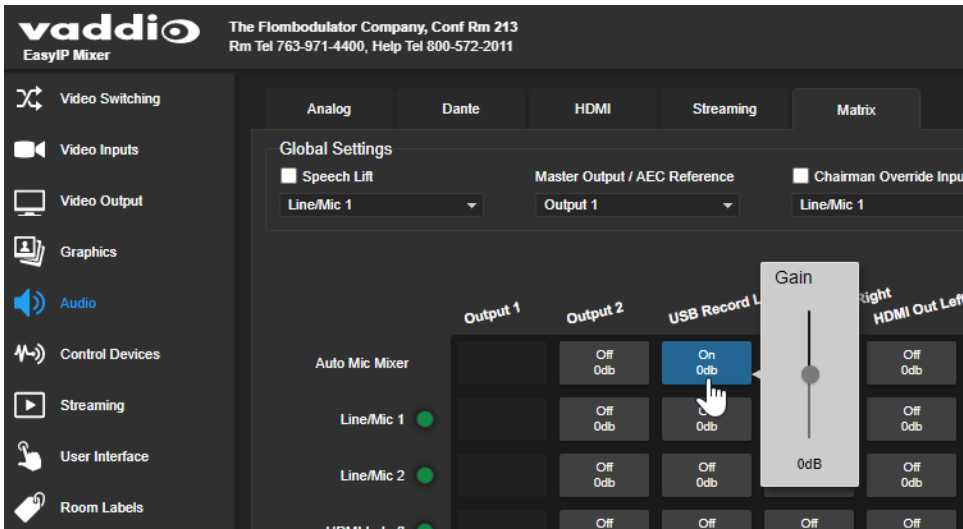

Working with Video – EasyIP Decoder

EASYIP DECODER – VIDEO SWITCHING PAGE

The EasyIP Decoder originates a USB stream with video from the input that is currently selected. When the Directory includes more than one camera or other video input, the Video Switching page lets you select which video input is active.

This page also presents the camera controls that would be available from the input camera's web interface.

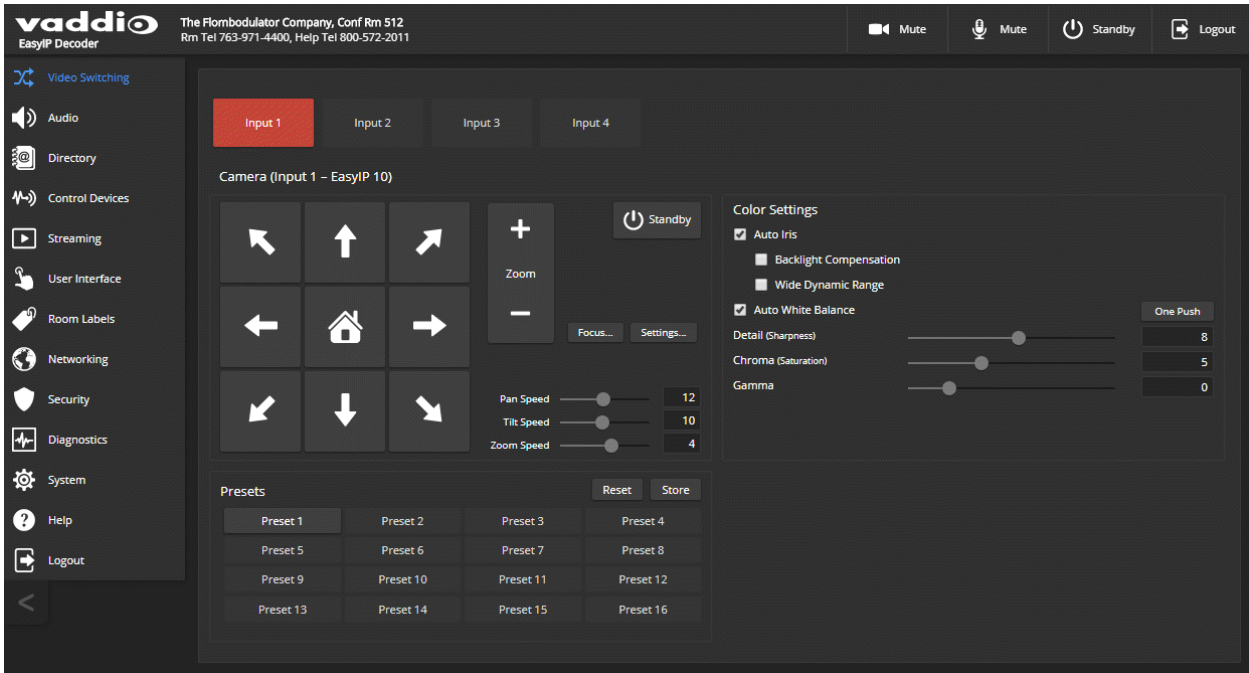

Changes that you make using the camera controls on this page (such as storing and naming presets) are stored on the camera.

Working with Video – EasyIP Mixer

The EasyIP Mixer brings the video capabilities of a presentation switcher to the EasyIP family. Video controls are available on these pages:

- **Video Switching** – Select the active video source, manage PIP and keying. This page is very similar to the operator's Home page in the non-administrative web interface.
- **Video Inputs** – Manage HDMI input settings, pair to and control EasyIP cameras on the network.
- **Video Outputs** – Manage HDMI output settings, PIP, and keying.

Working with the EasyIP Mixer's Video Inputs

VIDEO INPUTS PAGE

The web interface provides a control page with tabs for each camera and other video input device, allowing you to control the connected cameras without accessing their individual web interfaces. A red tally indicator identifies the tab for the current program source.

The tabs for EasyIP camera inputs present the same controls present in the paired cameras' own web interfaces.

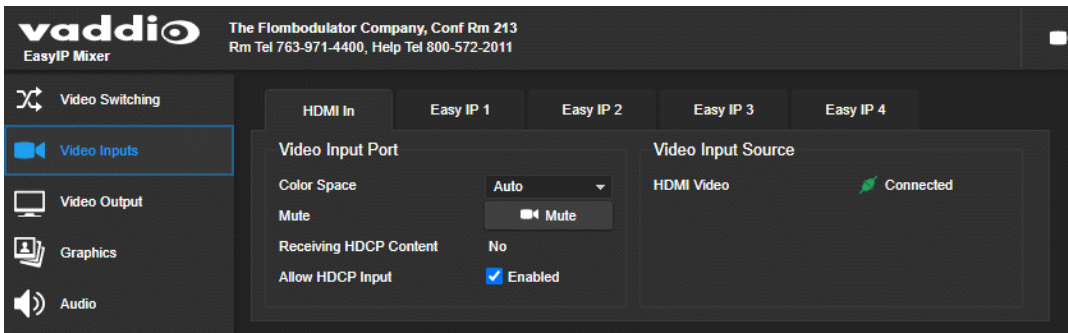

Configuring the EasyIP Mixer's Video Output

VIDEO OUTPUT PAGE

The Video Output page provides controls to configure the video on the local HDMI output. Controls include:

- Resolution/frame rate
- Color space
- Keying control and sources
- PIP control and layout

PIP control and layout is also available on the Video Switching page.

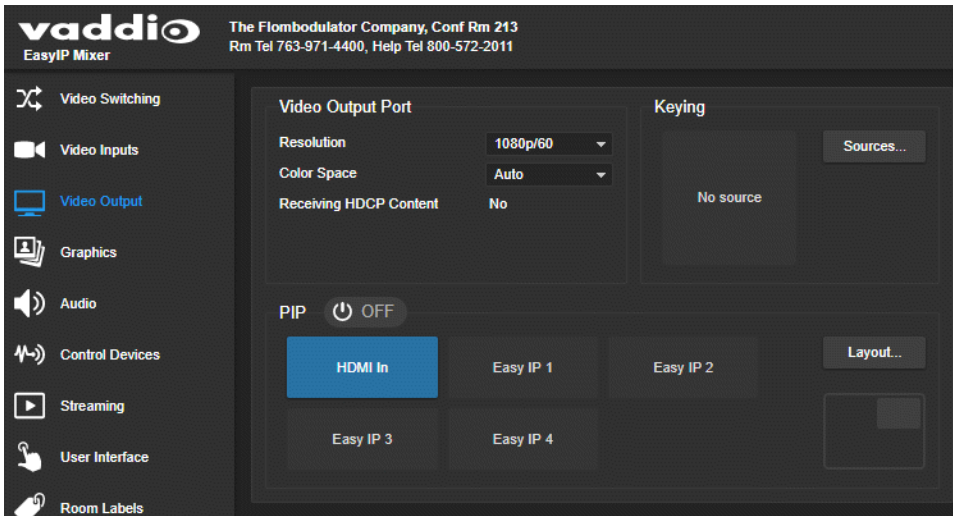

Working with Graphics – EasyIP Mixer

GRAPHICS PAGE

Use the graphics library to set up keying and placement for on-screen graphics.

To upload a graphics file:

1. On the Library tab, Select Upload. The Upload Graphics box opens.
2. Select Choose Files and browse to the file(s). File type may be .png or .jpg.

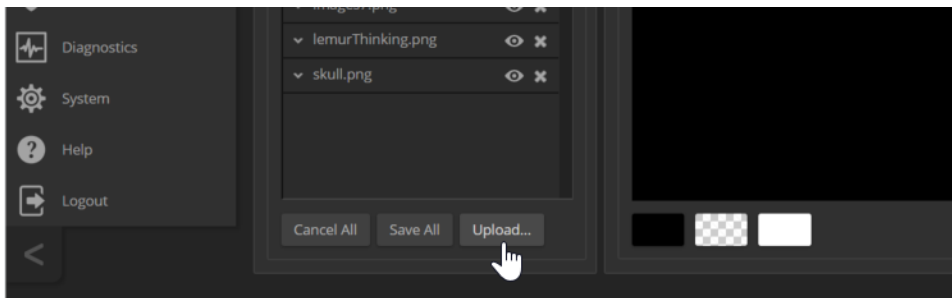

To place the graphic on the canvas and work with it:

1. Select the expand/collapse arrow associated with the filename to open the file information.
2. Select the View icon associated with the filename. Initially the image is placed at the top left corner of the canvas (coordinates 0,0).
3. Select the desired mask type – alpha, luma, chroma, or opaque.
4. Drag the image to the desired location on the canvas, or enter the desired offset from top left.

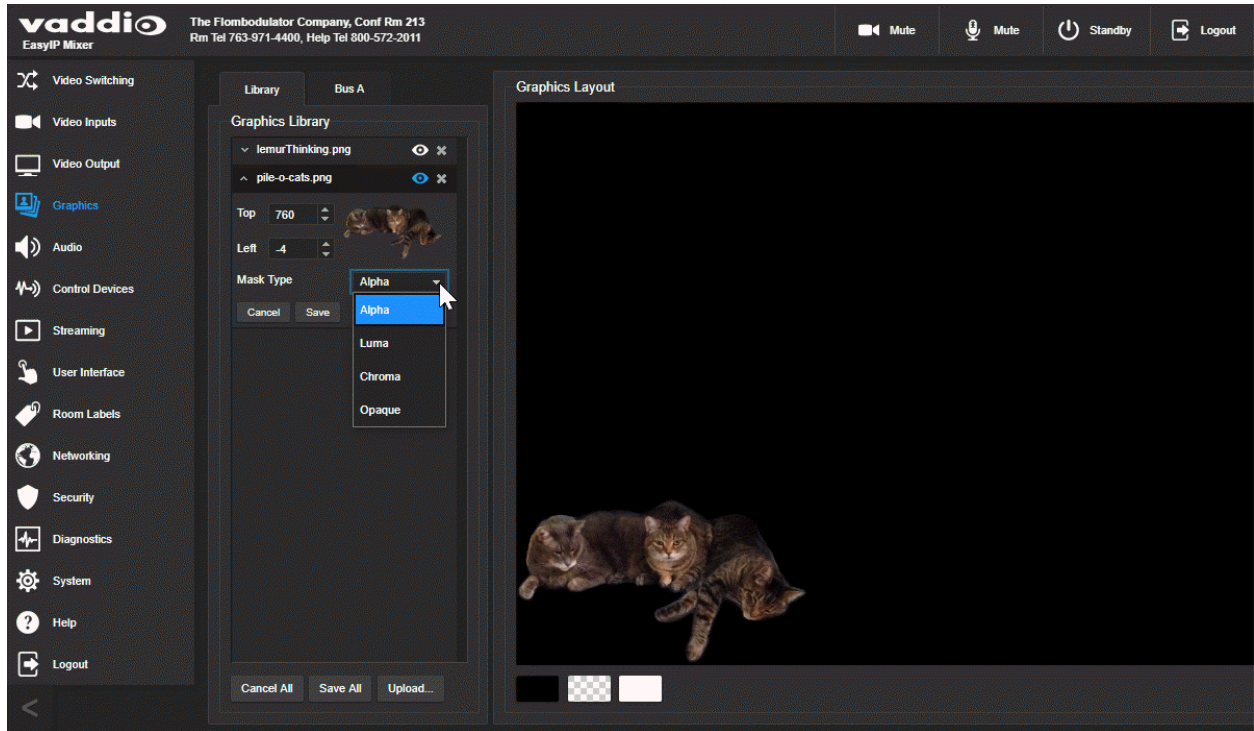

5. After making changes, save your work and select the expand/collapse arrow to close the file information dialog box.

To manage the graphics library:

Right-click the filename to edit it.
 Select the X to delete the file.

To work with keying layers:

1. On the Bus A tab, select Source to open the Layer Source box.
2. Select the desired mask type to view the graphics available.
3. Select the desired graphic.

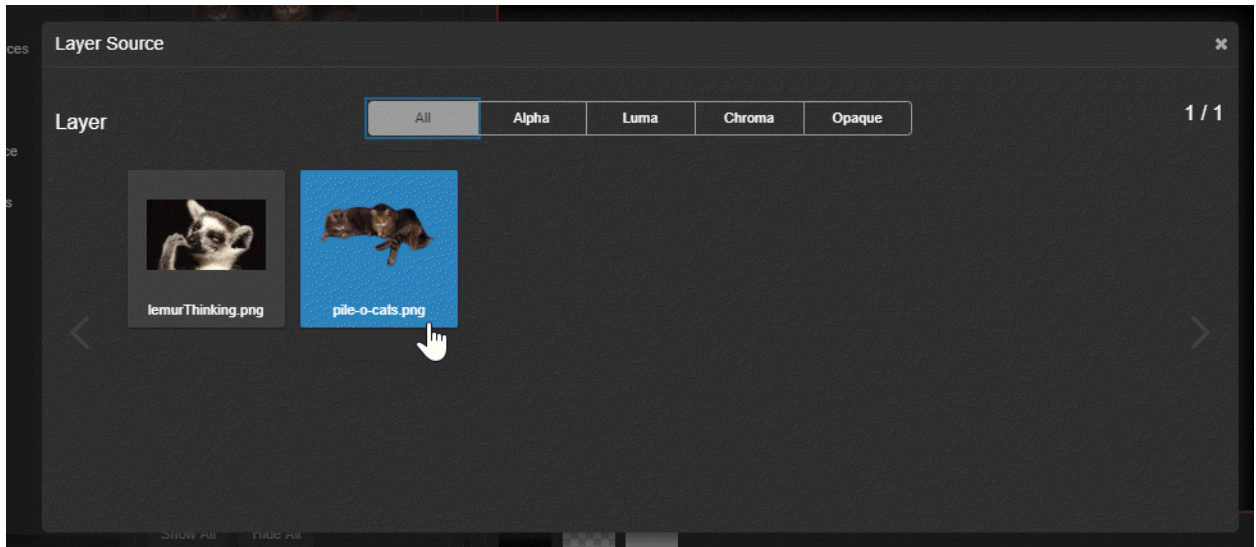

4. Select the X in the upper right corner of the Layer Source box to close it. The Bus A Layout display shows the graphic in the location where it was most recently placed. You can move the graphic in the layout display on either tab of the Graphics page.

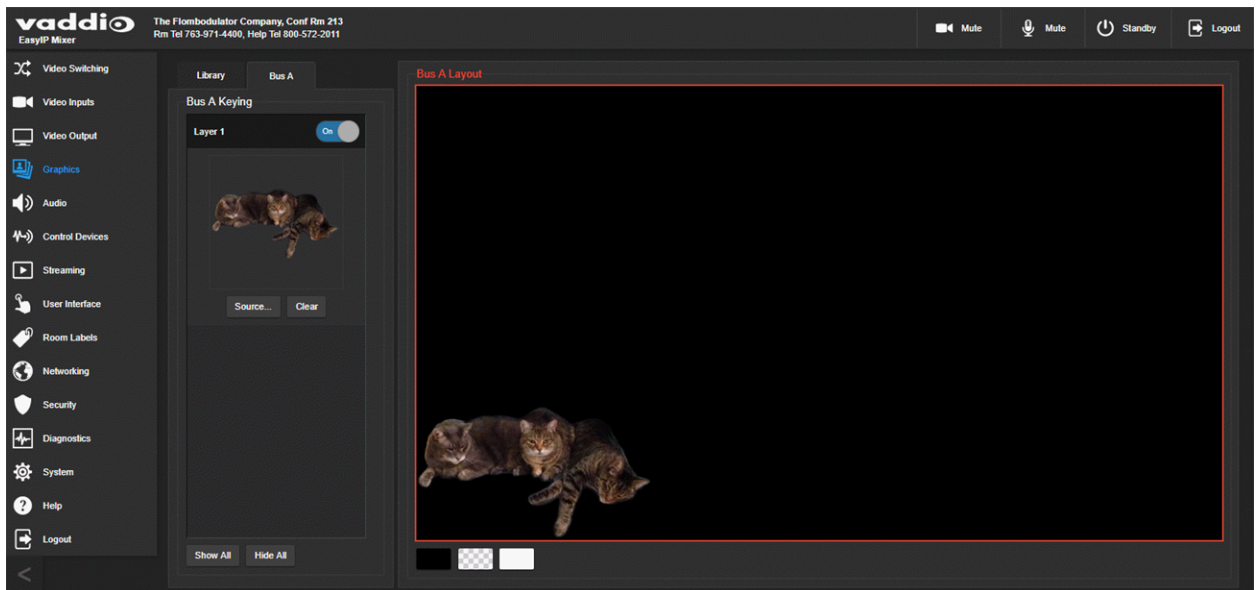

Setting up Macros and Triggers

CONTROL DEVICES PAGE

Macros are sequences of commands. Triggers register events or state changes that can be associated with macros, to make them run. For example, the One Touch (Home) button on a TableMIC is a trigger. When you associate a macro with a trigger, you must specify whether it runs when the trigger turns on, or when it turns off – so you can associate two macros with each trigger, one to run when the trigger is activated, and one to run when the trigger is turned off.

A trigger may be either hardware, such as the Home button on a tabletop microphone, or software. Software triggers allow you to program custom functions for third-party control devices, such as defining the buttons on a conference room touch-screen. Hardware triggers (labeled One Touch in the web interface) allow you to define responses to connected Vaddio trigger devices such as TableMIC microphones.

The macro can only run successfully if all the commands in the macro are able to run successfully. For example, if the macro sends the camera to a preset position, that preset must be defined. Refer to the [Telnet Serial Command API](#) section for a full list of commands.

The steps for working with macros and triggers are the same for the EasyIP Decoder and the EasyIP Mixer. The Control Devices pages differ in these ways:

- The EasyIP Decoder presents One Touch triggers to associate macros with the Home button on connected TableMIC microphones.
- The EasyIP Mixer presents hardware triggers to associate macros with devices connected to the Trigger port.

Writing and Editing Macros

CONTROL DEVICES PAGE, MACROS TAB

To define a macro:

1. Enter a name in the Macro Editor's Name field.
2. Enter one or more Telnet commands in the editing area. Note that camera commands must specify which camera they apply to – for example, `camera 1 tilt set 10` applies to the camera paired to input 1.
3. Optional but strongly recommended: Use the Test button to check your work while you are writing the macro.
4. Save your work when you are finished, or select New to start over.

Note

If the macro has external requirements, it will only run properly if those requirements are met. For example, if the macro includes a command to move to a preset, the applicable preset must be stored before the macro can run successfully. I know I'm repeating myself, but this is important.

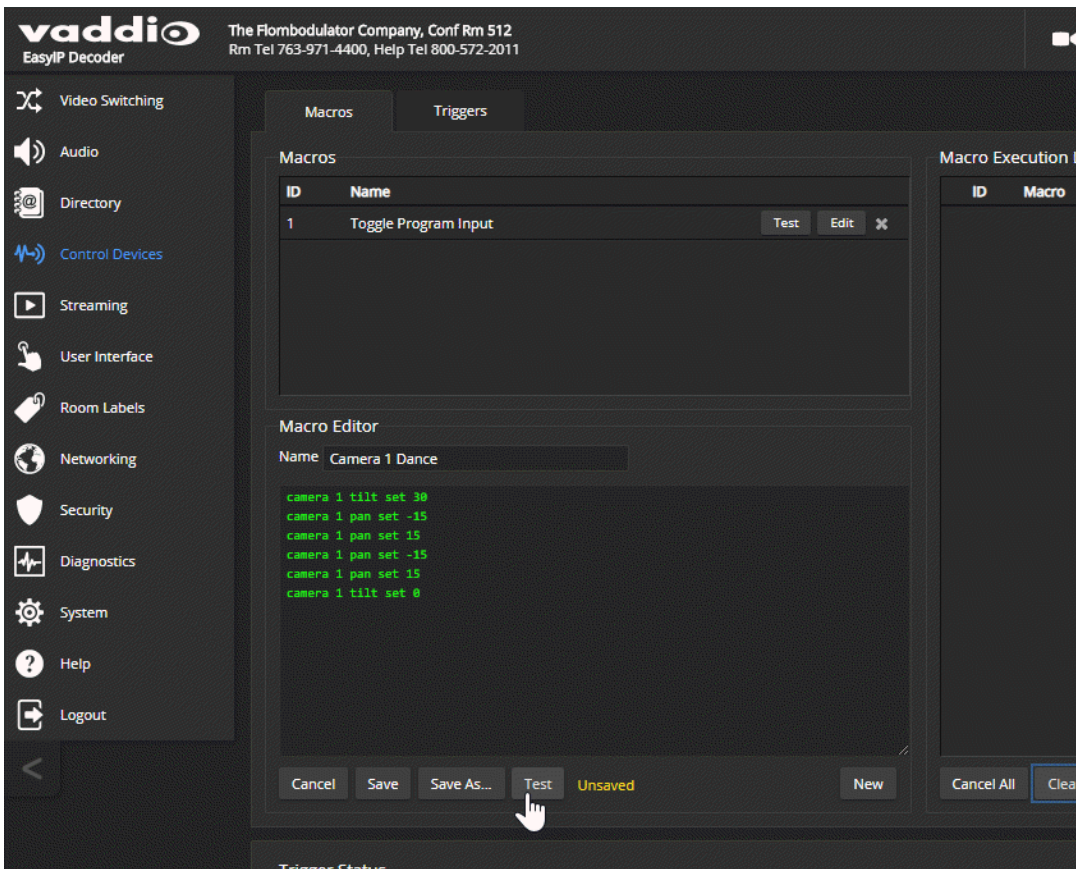

Testing Macros

CONTROL DEVICES PAGE, MACROS TAB

The Macro Editor has a Test button. You can test the macro while you are editing it, or after saving it. The Macro Execution Log shows the result of each command as the test runs.

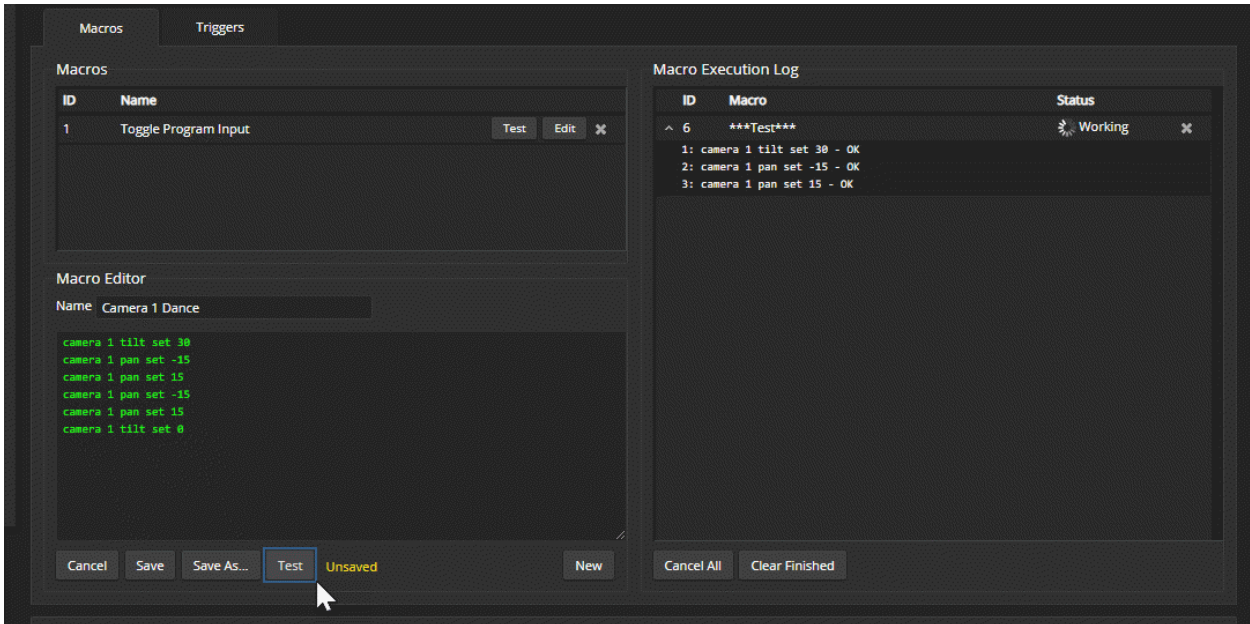

When the test finishes, the execution log shows a pass message or a fail message and hides the line-by-line results. If you need to debug the macro, you can expand the log again by selecting the down-arrow.

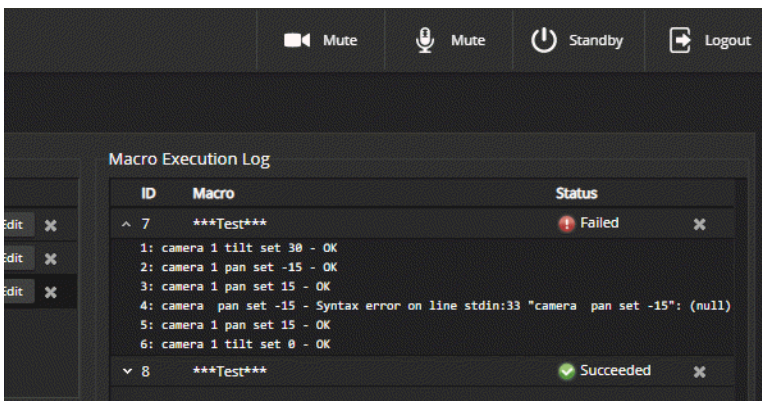
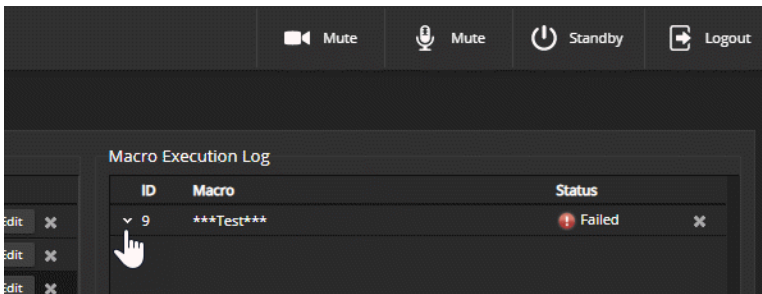

To edit an existing macro:

Select the Edit button associated with the macro, make your changes in the Macro Editor, and save your work.

To create a new macro based on an existing one:

Select the Edit button for the existing macro to open it, and use the Save As button to give it a new name. Then select its Edit button again, and make the desired changes.

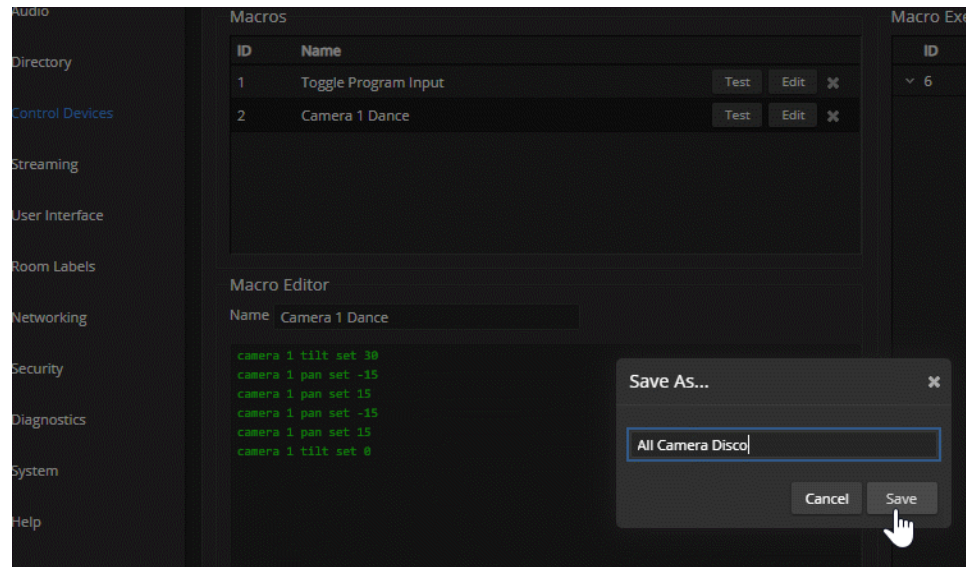

Assigning Macros to Triggers

CONTROL DEVICES PAGE, TRIGGERS TAB

A trigger may be associated with a macro that runs when the trigger is on, one that runs when the trigger is off, or one of each.

To assign a macro to a trigger:

Do at least one of these things:

- Select a macro in the Execute Macro on Enter field. This macro will start when the trigger turns on.
- Select a macro in the Execute Macro on Exit field. This macro will start when the trigger turns off.

Right-click a trigger label or test button to rename the trigger.

Example: Assigning a single macro to the Home button of the connected TableMIC microphone:

1. On the Macros tab of the Control Devices page, name and create the macro. Then test, debug, and save it.
2. If you want this macro to run every time you tap the TableMIC microphone's One Touch button, go to the Audio page and set the One Touch Button mode to Momentary. Otherwise it will run *every other time* you tap the button.
3. On the Triggers tab of the Control Devices page, locate One Touch in the list of trigger events, and select the macro from the list of available actions for Execute Macro On Enter.

To remove macro assignments from a trigger:

Select the X on that trigger's row. This is equivalent to setting both macros to (none).

The screenshot shows the Vaddio EasyIP Decoder web interface. The top navigation bar includes the Vaddio logo, contact information for The Flombulator Company, and status icons for Mute, Standby, and Logout. The left sidebar contains various system management categories like Video Switching, Audio, Directory, Control Devices, Streaming, User Interface, Room Labels, Networking, Security, Diagnostics, System, Help, and Logout. The main content area is titled 'Triggers' and contains a table of 'Trigger Events'.

Trigger	Execute Macro On Enter	Execute Macro On Exit	
Software 1	(none)	(none)	X
Software 2	(none)	(none)	X
Software 3	(none)	(none)	X
Software 4	(none)	(none)	X
Software 5	(none)	(none)	X
Software 6	(none)	(none)	X
Software 7	(none)	(none)	X
Software 8	(none)	(none)	X
Software 9	(none)	(none)	X
Software 10	(none)	(none)	X
One Touch 1	(none)	(none)	X
One Touch 2	(none)	(none)	X

A dropdown menu is open for the 'One Touch 1' row, showing the following options: (none), Toggle Program Input, and Camera 1 Dance. A mouse cursor is pointing at the 'Toggle Program Input' option.

Testing Triggers

CONTROL DEVICES PAGE

Just as it can be helpful to test macros when you write them, it can also be helpful to test triggers when you assign macros to them. The Trigger Testing section is available from both tabs of the Control Devices page.

To test a trigger:

1. Set Test Mode on. The web interface displays a notification.
2. Select the trigger to run the macro associated with turning the trigger on.
3. Select the trigger again to run the macro associated with turning the trigger off, if there is one.
4. Turn off Test Mode when you finish testing.

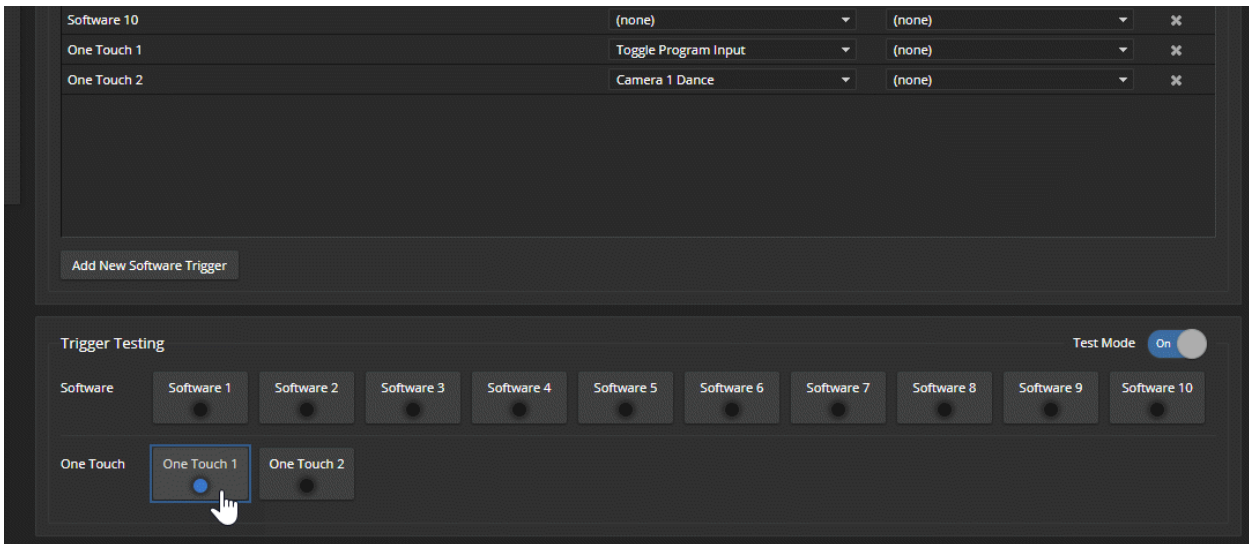

Note

Triggers are not available to the control device when Test Mode is selected.

Example: Assigning a Function to the Connected Microphone's Home Button

VIDEO SWITCHING PAGE, CONTROL DEVICES PAGE

In this example, two TableMIC microphones are connected to the EasyIP Decoder. The team that uses the conference room most frequently has requested that the Home button on the cameras' remote and the Home buttons on the two microphones should all do the same thing. The remote is normally set to control the camera that is paired to Input 1 of the EasyIP Decoder.

Tasks to accomplish this:

1. **Video Switching page:** Select Input 1, set up the shot and color adjustments on the camera, and store the Home preset.
2. **Control Devices page, Macros tab:** Create, name, test, and save a new macro that runs the `camera 1 home` command. For this example, we'll assume you name it Cam1 Home.
3. **Control Devices page, Triggers tab:** For the OneTouch 1 trigger, click the box in the Execute on Enter column and select the Cam1 Home macro from the list. Do the same thing for the OneTouch 2 trigger.

Locking the Front Panel Controls – EasyIP Mixer

USER INTERFACE PAGE

To disable the front panel controls, check the Front Panel Lock box in the System Configuration section of the User Interface page. The front panel message shows that the controls are locked, and displays the device's IP address.

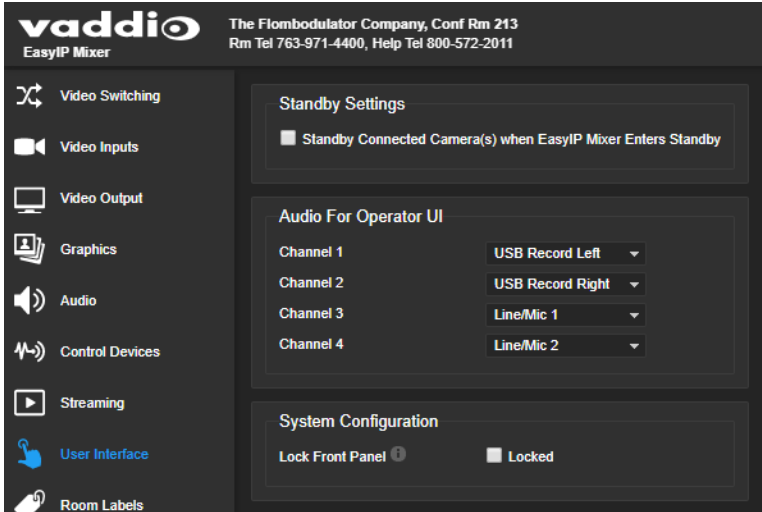

Configuring System Standby Behaviors

USER INTERFACE PAGE

EASYIP DECODER – SYSTEM PAGE, GENERAL TAB

To set standby behavior for cameras:

To control camera standby from the EasyIP Decoder or EasyIP Mixer, go to the User Interface page and select "Standby Connected Cameras when EasyIP Decoder Enters Standby."

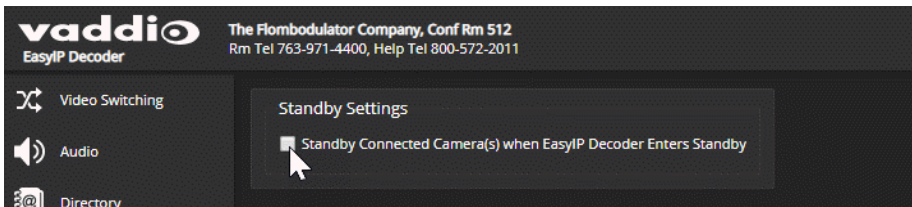

To automatically set the EasyIP Decoder to standby when no USB connection is present:

Go to the System page, select the General tab, and select "Standby Device when USB Disconnects."

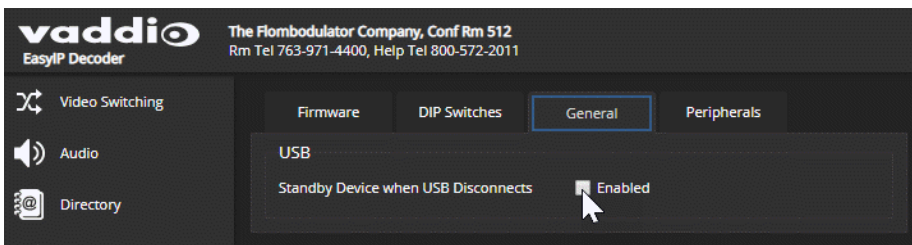

Configuring and Adjusting Cameras

Cameras are configured and adjusted individually. Most of the settings and adjustments are on the Camera page of the camera's administrative web interface.

- **Camera ID and image flip** – Set the room's cameras to respond to different frequencies from the IR Remote Commander, and correct the video orientation from inverted cameras.
- **Home position and other preset positions** – Define the position to which a camera moves when it comes out of standby mode, and any additional preset positions needed. Home and other presets include pan, tilt, and zoom information and may optionally include color adjustments. Presets 1 - 6 are available using the Vaddio IR Remote Commander; all defined presets are available from the operator's (non-administrative) web interface.
- **Color and lighting adjustments** – Each room may need different color and lighting settings. Cameras in different areas of the same room may also need different settings.
- **Speed adjustments** – Cameras have separate speed settings for manual movements and movements to presets.
- **Focus adjustment** – Focus controls are also available on the IR Remote Commander, but not in the operator's web interface.
- **Indicator light behavior** – By default, the camera's indicator light is on if the camera has power. You can change this.
- **Other camera settings** – Image orientation can be changed. This is helpful for ceiling-mounted cameras, unless you prefer upside-down video.

Setting Cameras to Respond Independently to the IR Remote

If two or more cameras are in a room, you can use an IR remote to control them independently if you set them to respond to different frequencies. The Vaddio IR Remote Commander can control up to three cameras independently.

To set cameras to respond to different frequencies:

1. Log in as admin to each camera's web interface.
2. On the System page, open the DIP Switches tab.
3. Set each camera to use IR 1, IR 2, or IR 3.

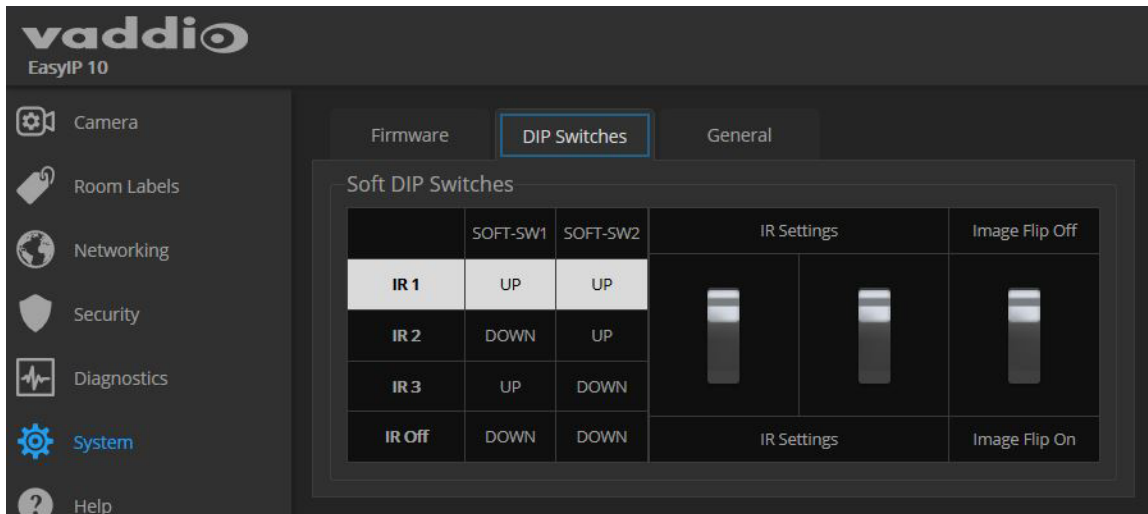

To select the camera to control with the remote:

Press Camera Select button 1, 2, or 3 to select or change the IR command frequency. The camera set to use that frequency will recognize commands from the remote.



Inverting the Image for Ceiling-Mounted Cameras

Mounting cameras on, in, or near the ceiling can create a clean-looking installation. To get a non-inverted image from an inverted camera, go to the System page's DIP Switches tab and set the Image Flip switch On.

Setting the Home Position and Other Preset Shots

CAMERA PAGE

Presets are saved shots. Each preset includes pan, tilt, zoom, and (optionally) color settings. When you reboot the camera or bring it out of standby, it returns to the Home preset.

Home and presets 1 through 6 are available with the IR Remote Commander; the others are only available from the web interface.

To store a preset:

1. Set up the shot.
2. In the Presets area, select Store to open the Store Preset dialog.

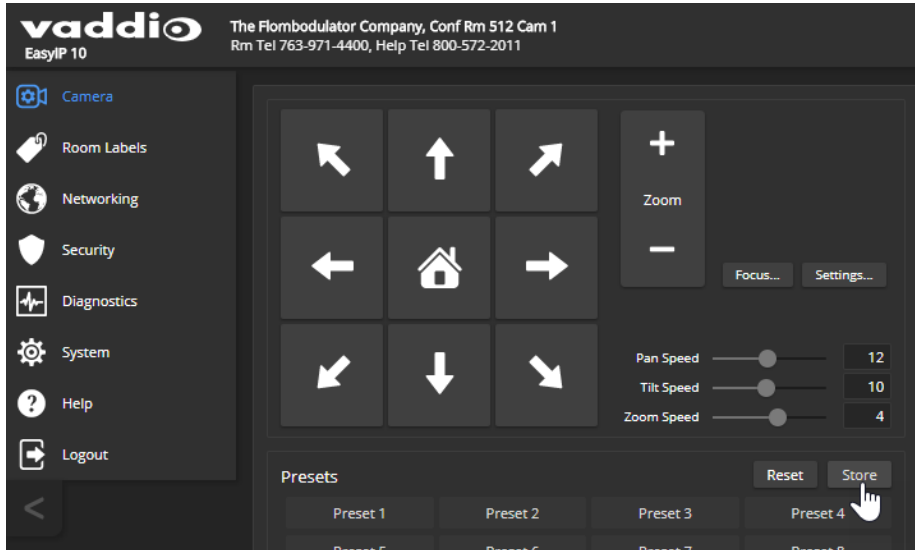

3. Select the preset to store. The preset button changes color.

Note

The Store Preset dialog box does not indicate whether presets have already been defined, but the main display dims the preset buttons if they have no preset information stored.

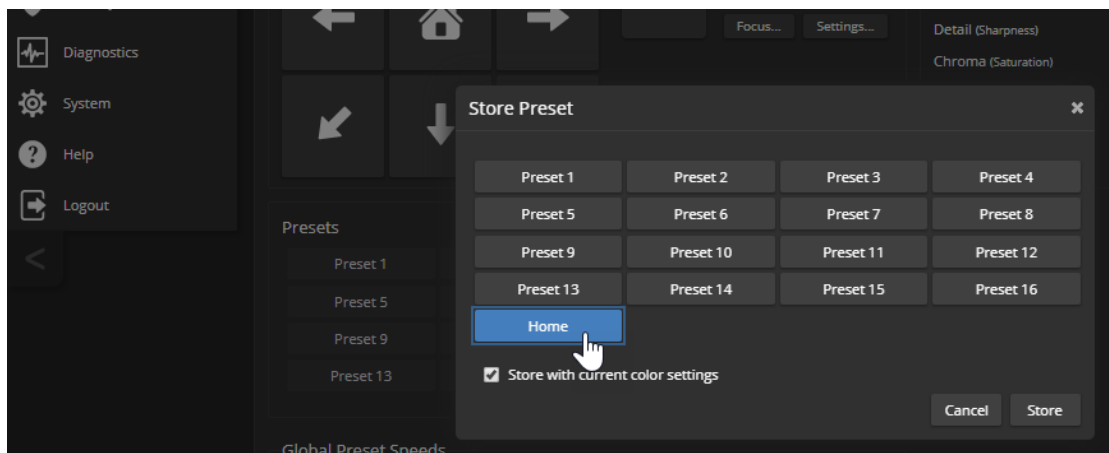

4. To save the current color settings along with the camera position, check Store with Current Color Settings.
5. Store the preset.

Renaming Presets

CAMERA PAGE

You can rename presets to identify them. This also helps you identify and avoid overwriting them when you store new ones.

Right-click the button for the preset, and edit the label.

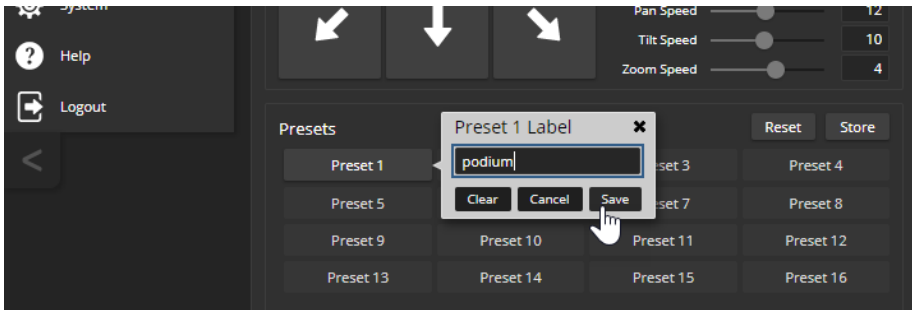

Adjusting the Color and Image Quality Settings

CAMERA PAGE

Fine-tune the color and lighting as needed using the Color Settings controls.

- **Auto Iris** allows the camera to compensate automatically for the light level. Clear this box to adjust iris and gain manually.
- **Backlight Compensation** (available when Auto Iris is selected) reduces contrast to adjust for bright light behind the main subject of the shot. This setting can't be used with Wide Dynamic Range.
- **Wide Dynamic Range** (available when Auto Iris is selected) increases the contrast between the brightest and darkest areas. This setting can't be used with Backlight Compensation.
- **Auto White Balance** adjusts color automatically. Clear this box to adjust red gain and blue gain manually.
- **Red Gain** and **Blue Gain** (available when Auto White Balance is not selected) provide manual color adjustment.
- **Detail** adjusts the image sharpness. If the video looks grainy or “noisy,” try a lower Detail setting.
- **Chroma** adjusts the color intensity.
- **Gamma** adjusts the range (gray density) between bright areas and shadows.

The [Lighting and Image Quality Quick Reference](#) and [Color Adjustment Quick Reference](#) may be helpful.

If you make a change that you don't like, start over by selecting and then deselecting Auto Iris (lighting) or Auto White Balance (color).

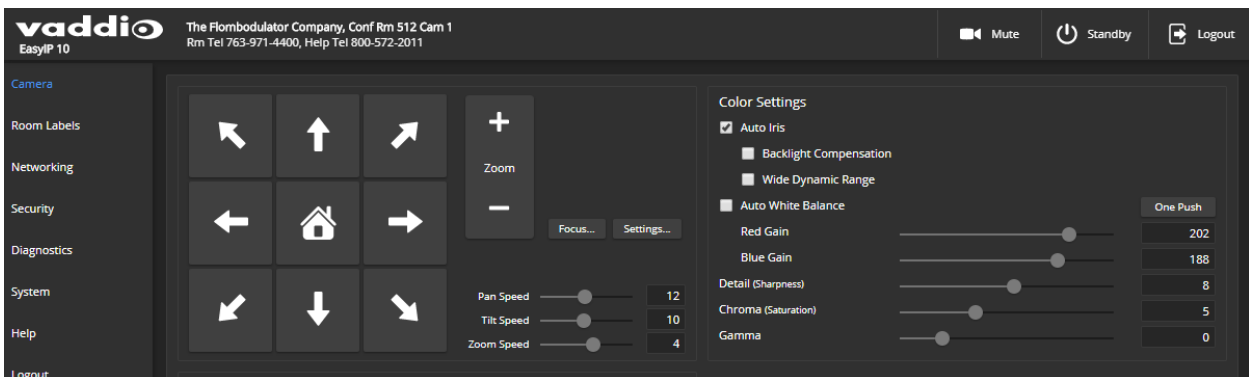

Lighting and Image Quality Quick Reference

Here are some tips for using the color settings for lighting and image quality.

What do you need to correct?	Make this adjustment:
The image is too dark	Increase Iris (lower F-stop value)
	Increase Iris Gain
The image looks washed out or faded	Decrease Iris (higher F-stop value)
	Decrease Iris Gain
	Increase Chroma
	Decrease Gamma
The subject is silhouetted against a bright background	Enable Backlight Compensation
Small sources of bright light (point sources) make it hard to see details in areas with less intense lighting.	Enable Point Light Compensation
Highlights and shadows look right, but mid-tones are too dark.	Increase Gamma
Shadows are too dark	Enable Wide Dynamic Range (WDR)
	Decrease Gamma
The image looks grainy	Decrease Detail
	Decrease Iris Gain
"Soft focus" effect; the image looks unrealistically smooth	Increase Detail

Color Adjustment Quick Reference

Here are some tips for using the color-related CCU settings.

What do you need to correct?	Make this adjustment:			
Colors look less vivid than they should	Increase Chroma			
Colors look too vivid	Decrease Chroma			
Colors look wrong; white objects do not appear white	Enable Auto White Balance			
	One Push White Balance			
	Disable Auto White Balance and... <ul style="list-style-type: none"> ■ adjust Red Gain (decrease for less red, increase for less green) ■ adjust Blue Gain (decrease for less blue, increase for less yellow) 			
Too much red	Not enough red	Too much blue	Not enough blue	Balanced

If you are adjusting for lighting conditions that are likely to recur, you can store presets with color settings.

Setting the Speeds for Manual Camera Movements

CAMERA PAGE

The Pan Speed, Tilt Speed, and Zoom Speed sliders control how fast the camera moves in response to the direction and zoom controls on the IR remote and in the web interface.

To set speeds for movements using the arrow buttons:

Use the speed sliders to adjust the speed of movements that you control with the buttons for pan, tilt, and zoom. For tight shots, slower is usually better.

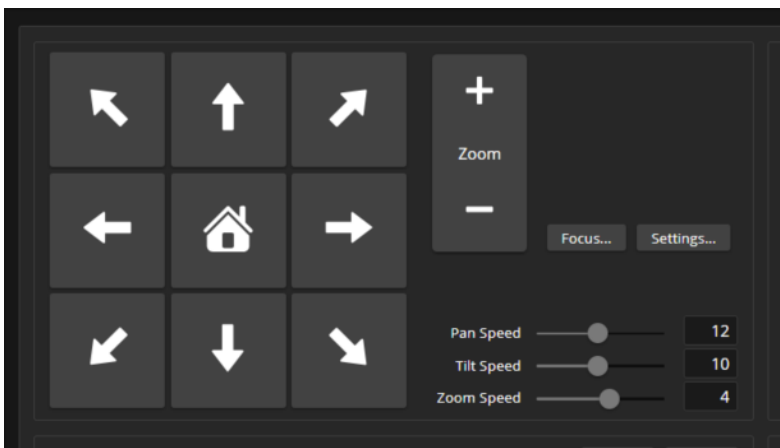

Setting the Speeds of Camera Movements to Presets

CAMERA PAGE

The Pan Speed, Tilt Speed, and Zoom Speed sliders in the Global Preset Speeds control how fast the camera moves to presets.

To set speeds for movements to presets:

In the Global Preset Speeds section, set the speeds for movements to presets.

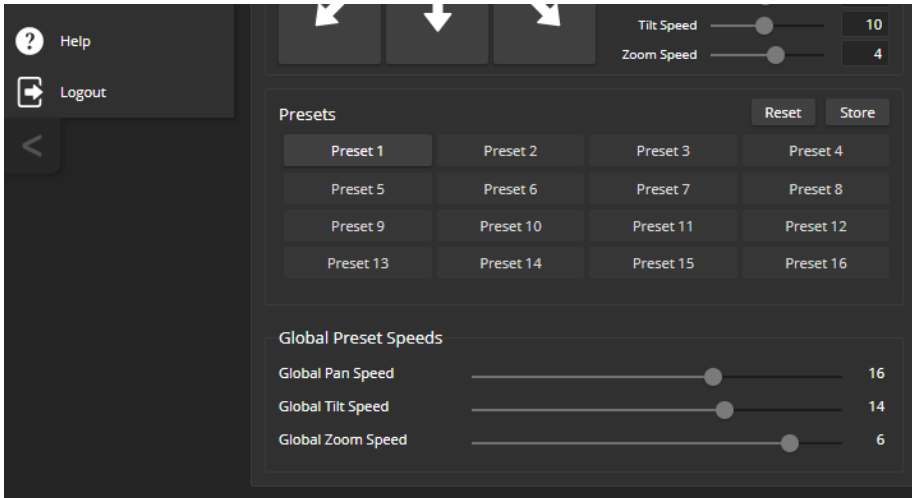

Setting the Direction for Camera Movements

CAMERA PAGE

By default, the arrow buttons on the remote and in the web interface show the direction you would see the camera move if you were looking the same direction as the camera. If a person facing the camera is controlling it with the remote, using the right arrow pans the camera to the person's left.

To make the arrow buttons indicate camera movement from the perspective of a person facing the camera, open the Settings control and invert the pan direction.

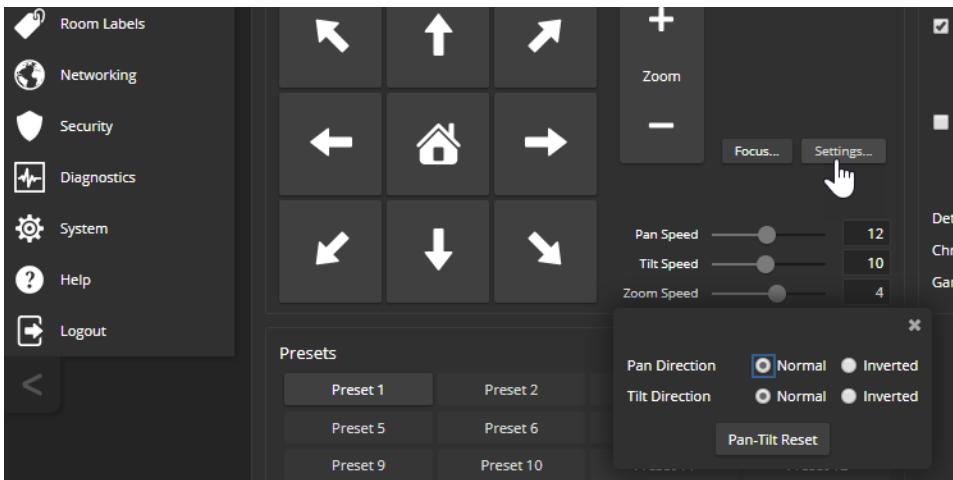

Adjusting the Focus

CAMERA PAGE

Open the Focus control to select Auto-focus, or set manual focus with the + (near) and – (far) buttons. The + and – buttons only work when Auto Focus is not selected.

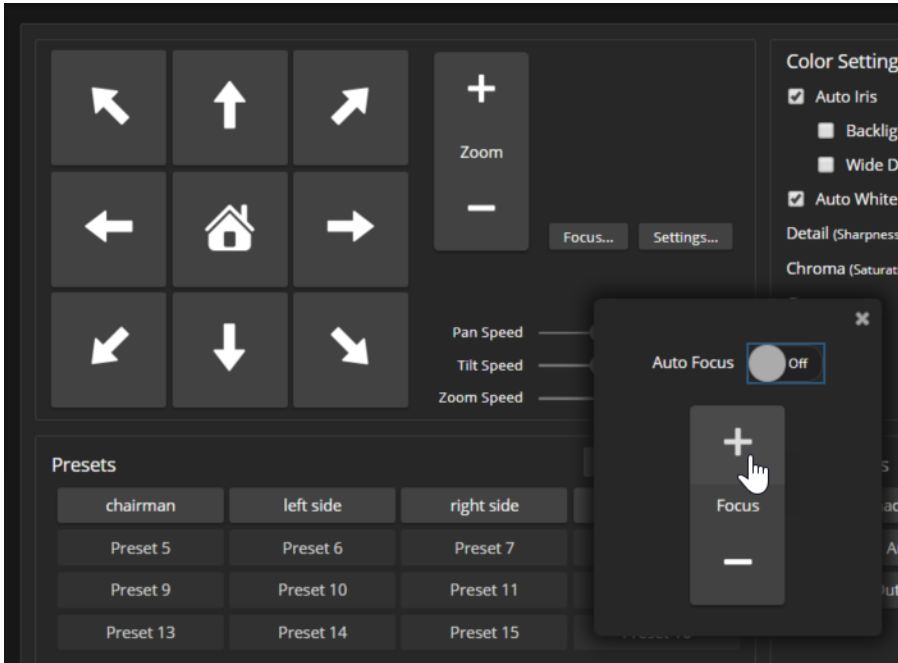

For users who are not logged in as admin, focus control is available via the IR Remote Commander.

Camera Indicator Light Settings

SYSTEM PAGE

The General tab of the System page provides settings to control the way the indicator light behaves.

LED On – In most cases, Vaddio recommends leaving the status light on, to let people in the room know whether the camera is currently sending video.

LED On in Standby – Select Disabled to turn off the LED when the camera is in standby mode.

LED color scheme – Status light color codes for Pro AV (broadcast) or UC (unified conferencing); default is Unified Communications.

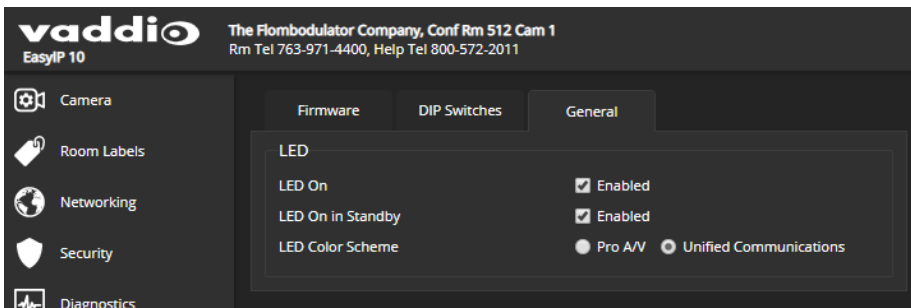

Other Camera Behavior Settings

CAMERA PAGE OR SYSTEM PAGE

To see the camera's basic settings, do one of these things:

- Select the Camera Settings button on the Camera page.
- Select the DIP Switches tab of the System page.

IR Settings (Camera ID) – The IR Remote Commander can control up to three cameras in the same room with different IR frequencies. Use **IR Settings** switches 1 and 2 to select the frequency to identify the camera as camera 1, 2, or 3; then use the Camera Select buttons at the top of the remote to select the camera you want to control.

Image Flip – If mounting the camera upside-down, set IMAGE FLIP ON. This orients the video image correctly and sets the tilt motors to respond appropriately to tilt commands from the remote, web interface, and connected control devices.

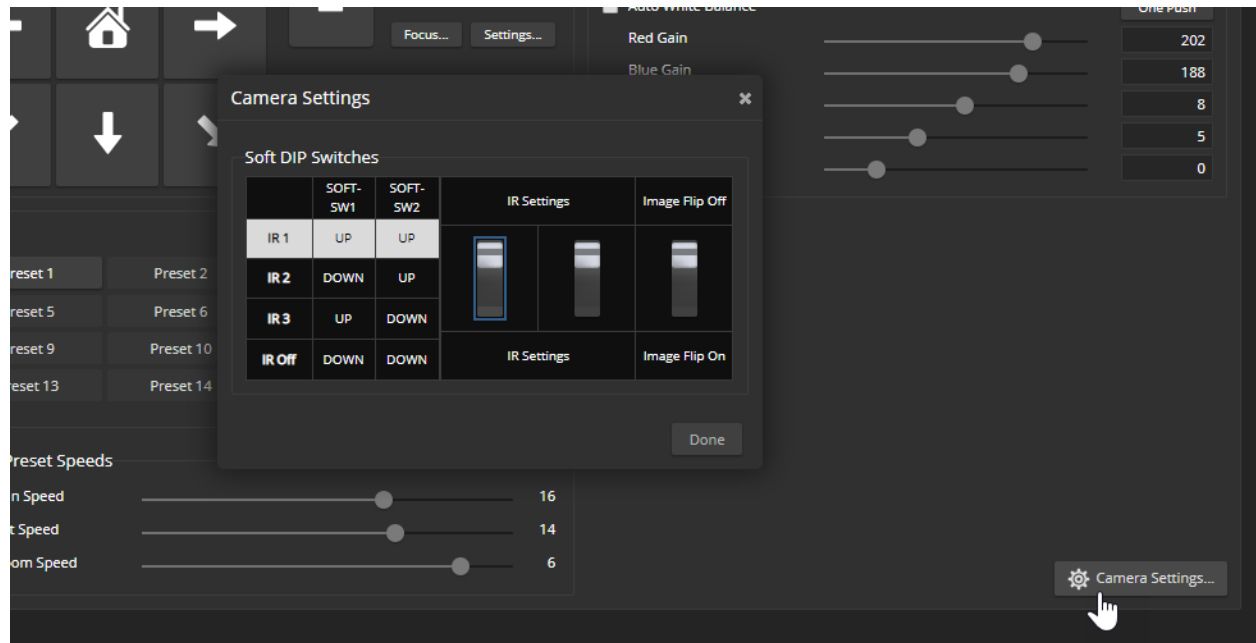

System Maintenance

This chapter covers maintenance tasks for the EasyIP system. Most of these are done from the affected device.

What's in this chapter:

- Saving and restoring a device's configuration data
- Updating the device's firmware
- Updating a connected EasyMIC microphone's firmware (EasyIP Decoder)
- Rebooting

Note

Some of the screen shots of these web interface pages are from the EasyIP Decoder and some are from the EasyIP 10 camera.

The System pages for the different products are similar to each other, but include product-specific features as well. For example, the EasyIP 10 camera's System page provides a control to recalibrate the camera's motors, and the EasyIP Decoder's System page includes a tab for updating the firmware on connected microphones.

Saving (Exporting) or Restoring (Importing) a Configuration

SYSTEM PAGE, FIRMWARE TAB

You can import a configuration to several devices of the same type if you need to configure them the same way. The devices must be of the same model and must have compatible firmware versions installed.

If you need to restore a device's factory default settings, you may want to export the configuration beforehand so that you can restore customized information.

Device	Included	Not Included
Camera	Home Presets	Color settings Speed settings
All devices	NTP and time zone information Room Labels	Hostname Passwords and other security settings

To export a configuration:

1. Configure the device with the time zone and room label. If you are working with a camera, store the presets you need.
2. Export the configuration (Export Data button). The export downloads to your computer as a .dat file. The filename is the device's hostname.

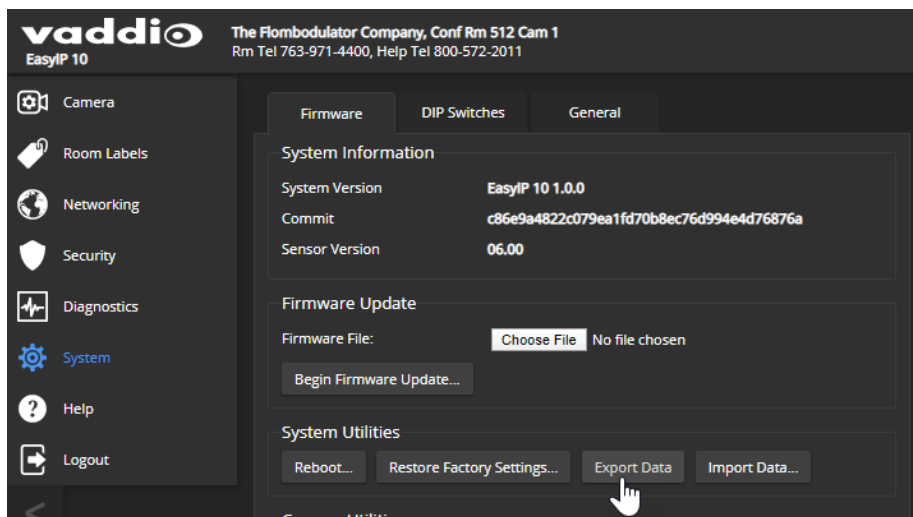

3. When you are ready to restore the configuration, select Import Data. The web interface prompts you to browse to the .dat file that will be imported.

To copy the configuration to a different device, do this step from the web interface of the device you need to configure.

Installing a Firmware Update

SYSTEM PAGE, FIRMWARE TAB

We release firmware updates from time to time. Some of them will be of interest to your organization; others might not be. The release notes provided with each update can help you to decide whether to install the update. The latest firmware and release notes are available on the product's web page at www.legrandav.com.

Caution

The device must remain connected to power and to the network during the update. Interrupting the update could make the decoder unusable.

1. Read the release notes and download the firmware.
2. Select Choose File, then browse to the downloaded firmware and select it. The filename ends with .p7m.
3. Select Begin Firmware Update.

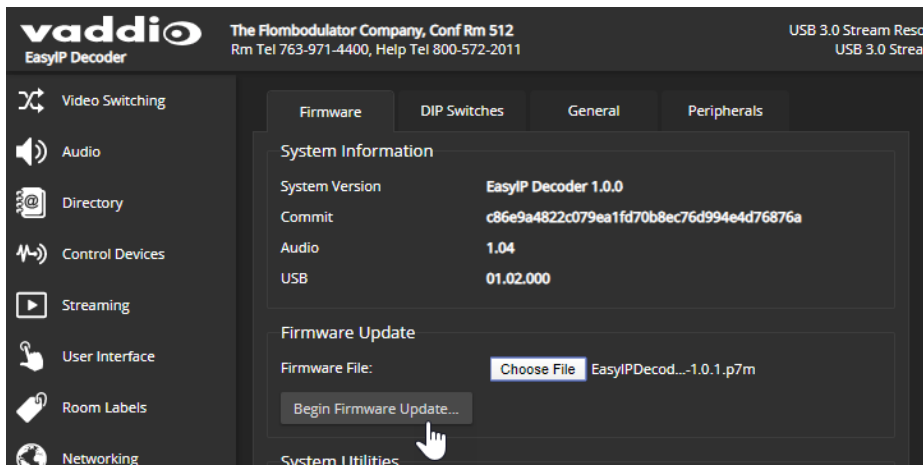

4. Read and understand the information in the Confirm dialog box.
5. Select Continue. A progress message box opens. If you are updating a camera, the indicator light on the front of the camera turns yellow. If the update process presents warnings or error messages, read them carefully.

The device reboots when the update is complete, and the web interface prompts you to log in again. Contact Vaddio Technical Support if you encounter any problems with the update.

Installing a Firmware Update for a Connected Vaddio Microphone – EasyIP Decoder

EASYIP DECODER SYSTEM PAGE, PERIPHERALS TAB

The process to update microphone firmware is similar to the process for updating other devices, but is done from the EasyIP Decoder.

1. Download the firmware and release notes. Microphone firmware is available on the microphone product page.
2. Select Choose File and navigate to the firmware file you downloaded.
3. Select the appropriate EasyMic port (1 or 2). You can only update one microphone at a time; this selection specifies which EasyMic connector the data will flow through.

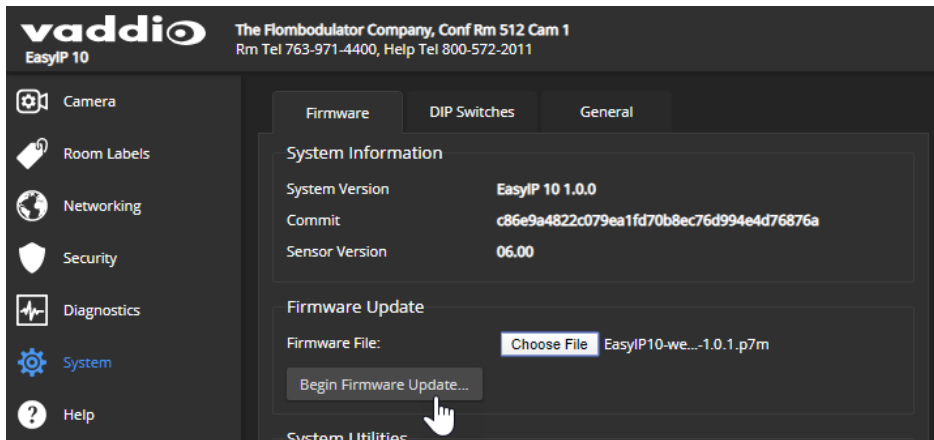

4. Select Begin Firmware Update.

Rebooting the Device

SYSTEM PAGE

This can help if a camera or other device stops responding as you expect. In the device's System Utilities section, select Reboot.

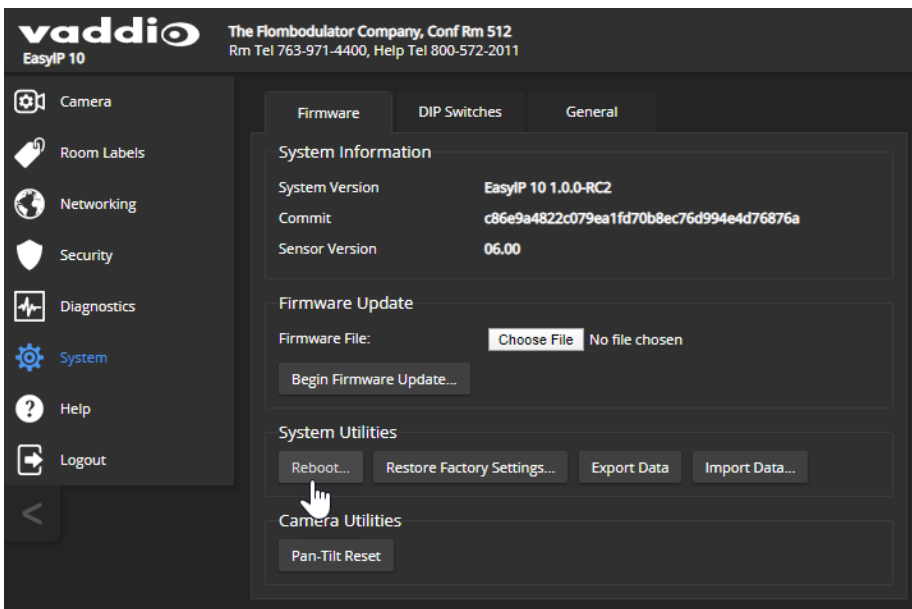

Using the Camera's Remote Control

The remote provides basic camera control.

If two cameras are in the same room, set them to respond to different IR frequencies (IR1, IR2, or IR3 settings on the System page's DIP Switches tab) and use the Camera Select buttons on the remote to specify which camera receives the commands. See [Setting Cameras to Respond Independently to the IR Remote](#).

Quick Reference

What do you need to do?	Button(s)
Power on or standby	Power (green button at top right)
Select the camera to control (if this remote controls more than one)	Camera Select buttons 1 through 3 (second row on the remote)
Discover the camera's IP address	Data Screen button (top left) – press and hold for 3 seconds
Move the camera	Arrow buttons and Home button (dark red)
Move the camera to a preset position	Position Preset buttons 1 through 6 (bottom two rows)
Focus the camera	Auto Focus button (near arrow buttons) Manual Focus buttons Near and Far (below Zoom Speed buttons)
Change zoom	Zoom buttons – T (telephoto – zoom in) and W (wide-angle – zoom out), slow and fast zoom speeds (center)
Adjust for excess light behind the camera's subject	Back Light button (top center)
Correct a motor calibration fault condition (blinking yellow light)	Pan-Tilt Reset button (center right, beside arrow buttons)

IR Remote Details

The remote provides the following functions:

Data Screen – Press and hold for 3 seconds to display the camera's IP address and MAC address on the near-end display. Press momentarily to dismiss the information.

Power indicator – Shows power on, IR transmission, and battery level.

Power – Switch the selected camera on or off.

Back Light – Use or turn off back light compensation.

Camera Select – In multi-camera installations, selects the camera to be controlled. See [Setting Cameras to Respond Independently to the IR Remote](#) for information on configuring the camera as camera 1, 2, or 3.

Pan/Tilt (arrow button) controls and Home button – Control the camera's position.

Std. Pan and Rev. Pan – Control how the camera responds to the arrow buttons. Helpful for ceiling-mounted cameras and installations where the camera will point at the person using the remote.

Pan/Tilt Reset – Recalibrate the pan and tilt motors. If the camera gets jostled, you may need to push this button to ensure that the camera moves accurately to its home and preset positions.

Auto Focus – Switch the camera to Auto-Focus mode.

Zoom Speed – Select Slow or Fast movements.

- **T** (slow and fast) – Telephoto (zooms in)
- **W** (slow and fast) – Wide-angle (zooms out)

Manual Focus – Switch the camera to Manual Focus mode.

Near (-) adjustment – Moves the focus nearer when in manual focus mode.

Far (+) adjustment – Moves the focus farther when in manual focus mode.

Position Presets 1 through 6 – Move the camera to a predefined position.

Preset – Save the camera's current position as one of the numbered presets.

Reset – Clear the saved position presets.



Storing a Preset Using the Remote

Set up the shot using the pan, tilt, and zoom controls. Then hold down the **Preset** button and press one of the numbered preset buttons.

Clearing a Preset Using the Remote

Press and hold the **Reset** button while pressing the preset number you want to clear.

Operating the System Using the Web Interface

Although the cameras have their own web interfaces, they can be operated from the EasyIP Decoder or EasyIP Mixer, which provides audio controls as well as video input selection and controls for the selected video input. Instructions and screen shots in this chapter are for the EasyIP Decoder unless otherwise noted.

By default, the web interface opens to a login page, but each EasyIP device can be configured to allow non-administrative access without logging in. Check with the system administrator if you need the credentials to log in.

The operator's page varies in appearance, depending on the controls that the system administrator sets up on the active input device.

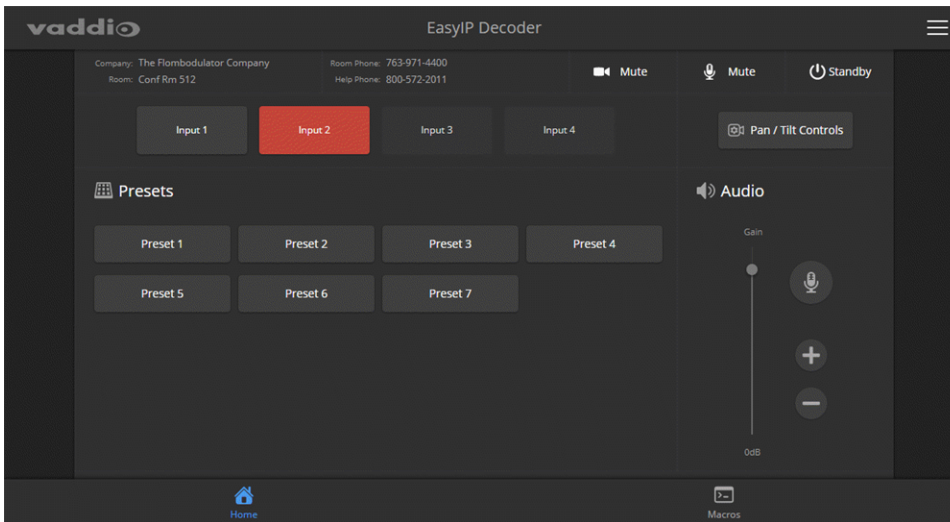

Quick Steps: Muting and Standby

All non-administrative pages of the web interface provide controls to do these things:

- **Mute all video** – HDMI Out and the USB and IP streams send the selected video mute pattern, either black video or color bars. Audio remains on unless you mute it also.
- **Mute all audio** – Disables the microphone inputs and the audio portion of the stream. It does not disable PC audio input or HDMI audio output; if you mute audio while playing content from a PC, the audio portion of the content is not muted. Video remains on unless you mute it also.
- **Set the system to standby mode** – Connected cameras may also go to standby mode, depending on how the system is configured.

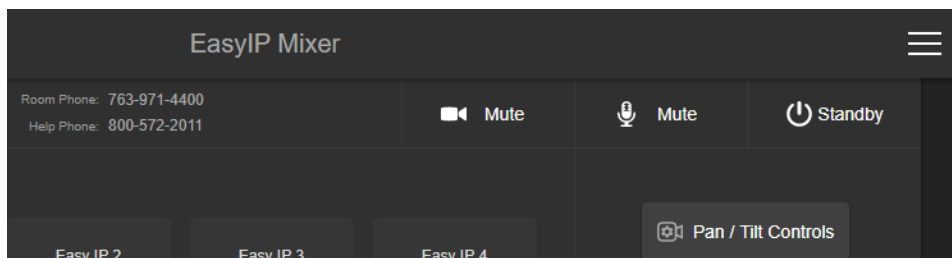

Working with Audio

EASYIP DECODER – OPERATOR'S HOME PAGE

EASYIP MIXER – OPERATOR'S AUDIO PAGE

Audio controls include mute/unmute buttons, volume read-outs, and volume slider controls for the audio output currently used as the master/AEC reference and for USB Record (the audio originating at your end of a conference).

For the EasyIP Mixer, up to four audio channels may be available on the operator's Audio page. Each provides a mute/unmute button, volume read-out, and volume slider control. The system administrator selects the audio channels available on this page.

Moving the Camera to a Preset Position

Camera presets are available from

- The web interface of each camera
- The web interface of the EasyIP Decoder or EasyIP Mixer
- The IR Remote Commander

Presets are only available if they have been set in the camera's administrative interface.



Accessing Camera Controls

EASYIP DECODER

Select Pan/Tilt Controls to open these controls for the selected camera:

- Directional controls
- Home button
- Zoom
- Focus

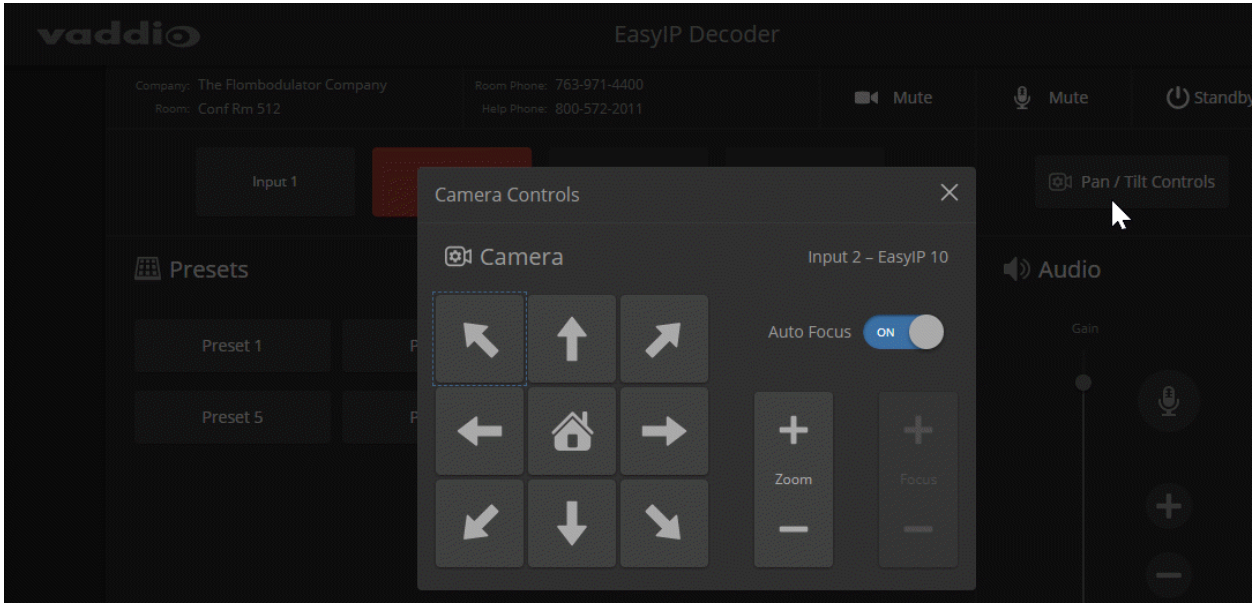

Moving the Camera Manually

The web interface provides direction and zoom controls similar to the ones on the IR Remote Commander. Use the arrow buttons for camera pan and tilt. The center button moves the camera to the home position. Use the Zoom + button to zoom in and the Zoom – button to zoom out.

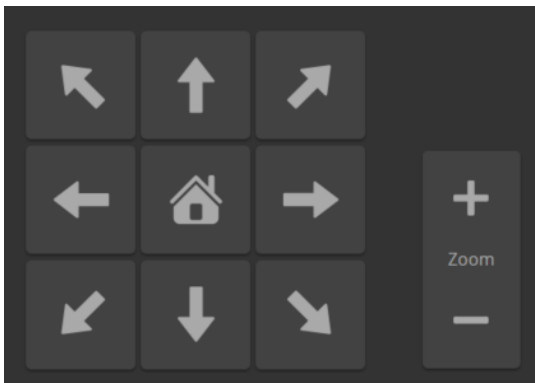

Selecting a PIP Source and Layout

OPERATOR'S HOME PAGE

In the web interface, the button for the active PIP source is highlighted.

1. Select the camera or other video source to use as the PIP source.
2. Select Layout to open the layout selection box.
3. Select the desired screen layout.
4. Select the Done button to dismiss the layout selection box.

Working with On-Screen Graphics – EasyIP Mixer

GRAPHICS PAGE

To use or hide the currently selected graphic, select it in the Keying area.

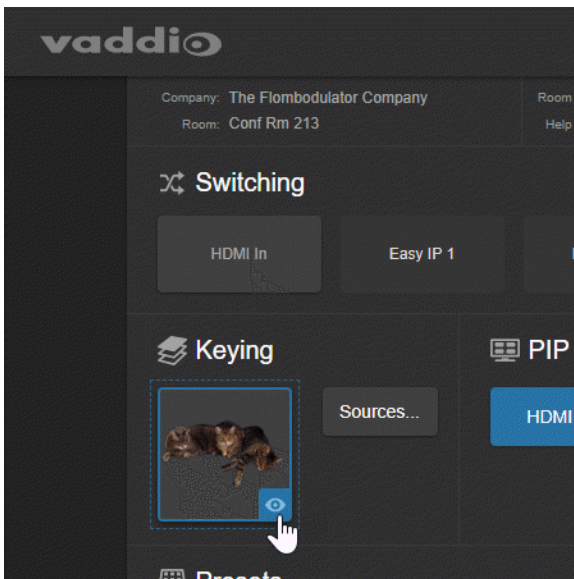

To select a different graphic:

1. Select Sources. The Keying > Sources (Bus A) box displays the graphics available for the layer you select.
2. To delete a graphic from a layer, select the X to the right of the filename.
3. To add a graphic or change the graphic associated with a layer, select the desired graphic.
4. Select Done to return to the main screen.

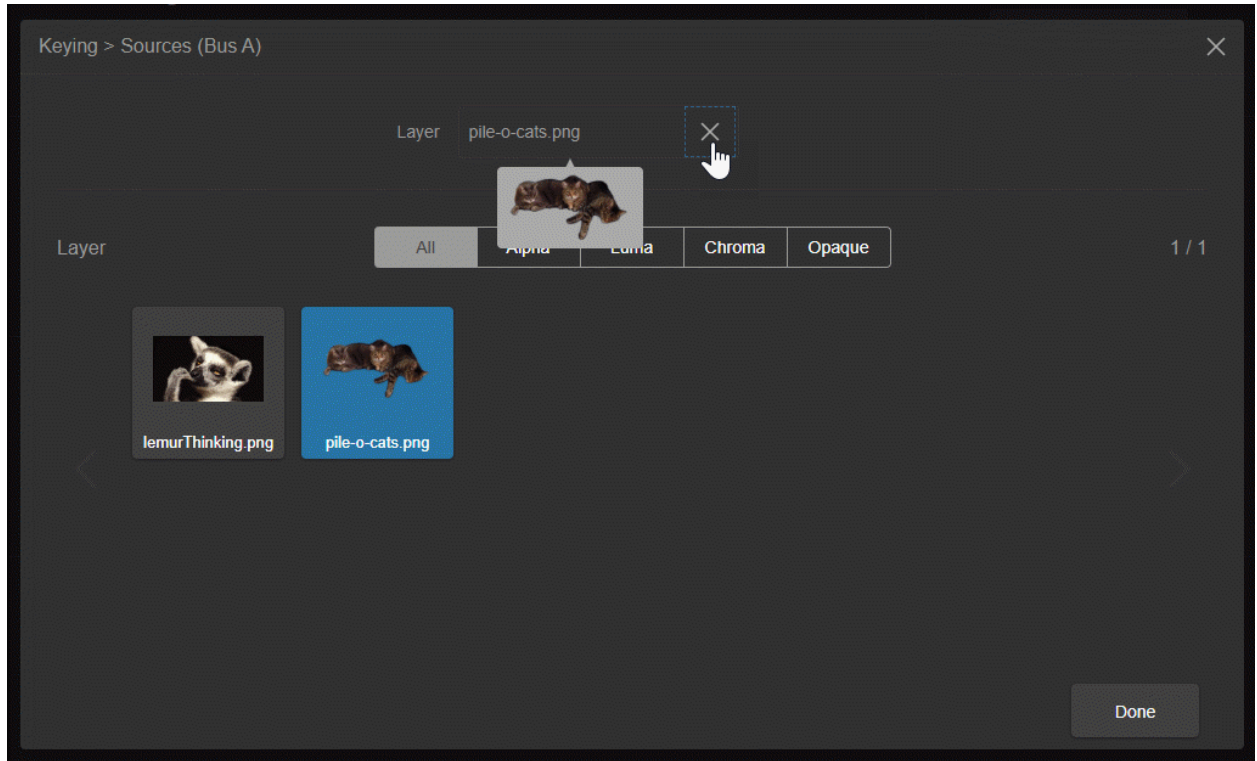

Telnet Serial Command API

The Vaddio Telnet command API allows an external device such as an AMX or Crestron presentation system to control Vaddio products. It is also used for writing macros.

By default, Telnet access is disabled on new Vaddio devices. Telnet access must be enabled on the device. Network connectivity and a Telnet client are also required. Telnet port 23 is used.

In addition to the device-related commands, Telnet session management commands are available – help, history, and exit.

Notes

By default, Telnet access is disabled. Enable it on the Security page of the web interface.

When you connect via Telnet, you must log in using the admin account.

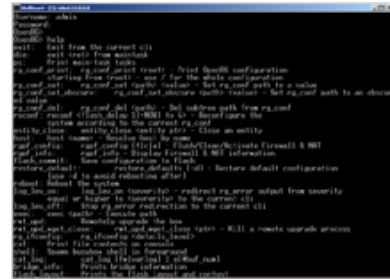

Things to know about Telnet:

- The > character is the command prompt.
- Using a question mark as a command parameter will bring up a list of available subcommands or parameters. Example:

```

camera led ?
get      Get the current LED toggle
on       Turn the LED on
off      Turn the LED off
    
```

- CTRL-5 clears the current serial buffer on the device.

Typographical conventions:

- n{x | y | z} – Choose x, y, or z.
- n <variable> – Substitute the desired value here.
- n < x - y > – Valid range of values is from x through y.
- n [optional] – Parameter is not required.

Camera Commands

These commands can be sent directly to a specific camera.

Some can also be sent directly to the camera or to the EasyIP Decoder or EasyIP Mixer, which will pass them to the camera:

- camera home
- camera pan
- camera tilt
- camera zoom
- camera focus
- camera preset
- camera ccu get/set
- camera standby

When sending any of these commands to the EasyIP Decoder or EasyIP Mixer, you must specify the camera input – camera 1 or camera 2 for the EasyIP Decoder, camera 2 through camera 5 for the EasyIP Mixer.

Some camera control commands must be sent directly to the camera, as they are not supported on the other EasyIP devices:

- camera led
- camera icr
- camera recalibrate

camera home

Moves the camera to its home position.

When sending the command to the EasyIP Decoder or EasyIP Mixer, you must specify the camera input. Camera inputs for the EasyIP Decoder are inputs 1 through 4. Camera inputs for the EasyIP Mixer are inputs 2 to 5, corresponding to camera inputs 1 through 4. Input 1 is reserved for HDMI in.

Synopsis	camera <input>* home * <input> used only when sending commands to the EasyIP Decoder or EasyIP Mixer	
Options	<input>	Specifies the camera to control.
Example	camera 1 home OK > (Sent from the EasyIP Decoder) Moves the camera paired to input 1 to its home position.	

camera pan

Moves the camera horizontally.

When sending the command to the EasyIP Decoder or EasyIP Mixer, you must specify the camera input.

Camera inputs for the EasyIP Decoder are inputs 1 through 4. Camera inputs for the EasyIP Mixer are inputs 2 to 5, corresponding to camera inputs 1 through 4. Input 1 is reserved for HDMI in.

Synopsis	camera <input>* pan { left [<speed>] right [<speed>] stop get set <position> [<speed>] } * <input> used only when sending commands to the EasyIP Decoder	
Options	<input>	Specifies the camera to control.
	left	Moves the camera left.
	right	Moves the camera right.
	speed <1 - 24>	Optional: Specifies the pan speed (integer 1 to 24). Default speed is 12.
	stop	Stops the camera's horizontal movement.
	set <position>	Sets the camera's absolute pan position in degrees, as a floating point value between approximately -155.00 and 155.00. This is the minimum range. Individual cameras may have slightly more travel before they reach their physical limits. The camera pan set command blocks execution of subsequent commands until the camera reaches the specified position.
get	Returns the camera's absolute pan position in degrees, as a floating point value between approximately -155.00 (left) and 155.00 (right).	
Examples	<pre>>camera pan left OK ></pre> <p>(Sent to the camera) Pans the camera left at the default speed.</p> <pre>>camera 1 pan right 20 OK ></pre> <p>(Sent to the EasyIP Decoder) Pans the Input 1 camera right using a speed of 20.</p> <pre>>camera pan set -15 OK ></pre> <p>(Sent to the camera) Pans the camera to 15° left of its centerline at the default speed.</p>	

camera tilt

Moves the camera vertically.

When sending the command to the EasyIP Decoder or EasyIP Mixer, you must specify the camera input.

Camera inputs for the EasyIP Decoder are inputs 1 through 4. Camera inputs for the EasyIP Mixer are inputs 2 to 5, corresponding to camera inputs 1 through 4. Input 1 is reserved for HDMI in.

Synopsis	<code>camera <input>* tilt { up [<speed>] down [<speed>] stop get set <position> [<speed>] }</code> * <input> used only when sending commands to the EasyIP Decoder or EasyIP Mixer	
Options	<input>	Specifies the camera to control.
	up	Moves the camera up.
	down	Moves the camera down.
	<speed >	Optional: Integer 1 to 20; Specifies the tilt speed. Default speed is 10.
	stop	Stops the camera's vertical movement.
	set <position>	<p>Sets the camera's absolute tilt position in degrees, as a floating point value between -30.00 and 93.00.</p> <p>The <code>camera tilt set</code> command blocks execution of subsequent commands until the camera reaches the specified position.</p>
	get	<p>Returns the camera's absolute tilt position in degrees, as a floating point value between approximately -30.00 (down) and 93.00 (up). Note that the range is 30.00 to -93.00 if Image Flip is selected.</p>
Examples	<pre>>camera tilt up OK > (Sent to the camera) Tilts the camera up at the default speed. >camera 1 tilt down 20 OK > (Sent to the EasyIP Decoder) Tilts the specified camera down at a speed of 20. >camera tilt set -5 OK > (Sent to the camera) Tilts the camera 5° down from level at the default speed.</pre>	

camera zoom

Moves the camera in toward the subject or out away from the subject.

When sending the command to the EasyIP Decoder or EasyIP Mixer, you must specify the camera input.

Camera inputs for the EasyIP Decoder are inputs 1 through 4. Camera inputs for the EasyIP Mixer are inputs 2 to 5, corresponding to camera inputs 1 through 4. Input 1 is reserved for HDMI in.

Synopsis	camera <input>* zoom { in [<speed>] out [<speed>] stop get set <position> } * <input> used only when sending commands to the EasyIP Decoder or EasyIP Mixer	
Options	<input>	Specifies the camera to control.
	in	Zooms the camera in.
	out	Zooms the camera out.
	<speed>	Optional: Integer 1 to 7; specifies the zoom speed.
	stop	Stops the camera's zoom movement.
	set	Sets the camera's zoom level as a floating point value between 1.00 and 10.00.
	get	Returns the camera's zoom setting as a floating point value between 1.00 and 10.00.
	<zoom>	Integer 1 to 10; specifies the zoom level.
Examples	<pre>>camera zoom in OK > (Sent to the camera) Zooms the camera in at the default speed. >camera zoom stop OK > (Sent to the camera) Stops the zoom motion. >camera 2 zoom set 7 OK > (Sent to the EasyIP Decoder) Zooms camera 2 to zoom level 7.</pre>	

camera focus

Changes the camera focus.

When sending the command to the EasyIP Decoder or EasyIP Mixer, you must specify the camera input. Camera inputs for the EasyIP Decoder are inputs 1 through 4. Camera inputs for the EasyIP Mixer are inputs 2 to 5, corresponding to camera inputs 1 through 4. Input 1 is reserved for HDMI in.

Synopsis	camera <input>* focus { near [<speed>] far [<speed> stop mode {get auto manual} } * <input> used only when sending commands to the EasyIP Decoder	
Options	<input>	Specifies the camera to control.
	near	Brings the focus nearer to the camera. Can only be used when camera is in manual mode.
	far	Moves the focus farther from the camera. Can only be used when camera is in manual mode.
	<speed>	Optional: integer (1 to 8) specifies the focus speed.
	mode [get auto manual]	Returns the current focus mode, or specifies automatic or manual focus.
Examples	<pre> camera focus near 2 OK > </pre> <p>(Sent to the camera) Brings the focus near at a speed of 2.</p> <pre> camera 2 focus mode get auto_focus: on OK > </pre>	
	<p>(Sent to the EasyIP Decoder) Returns the current focus mode of the Input 2 camera.</p>	



camera preset

Moves the camera to the specified preset, or stores the current camera position.

When sending the command to the EasyIP Decoder or EasyIP Mixer, you must specify the camera input.

Camera inputs for the EasyIP Decoder are inputs 1 through 4. Camera inputs for the EasyIP Mixer are inputs 2 to 5, corresponding to camera inputs 1 through 4. Input 1 is reserved for HDMI in.

Synopsis	camera <i><input></i> * preset { recall store} [1 - 16] [save-ccu] * <i><input></i> used only when sending commands to the EasyIP Decoder	
Options	<i><input></i>	Specifies the camera to control.
	recall <1 - 16>	Moves the camera to the specified preset.
	store <1 - 16>	Stores the current camera position as the specified preset.
	save-ccu	Optional: Saves the current CCU (color and lighting) settings as part of the preset. If not specified, the last color settings are used when recalled.
Examples	<pre>>camera preset recall 3 OK ></pre> <p>(Sent from the camera) Moves the camera to preset 3.</p> <pre>>camera 3 preset store 1 OK ></pre> <p>(Sent from the EasyIP Decoder) Saves the Input 3 camera's current position as preset 1.</p>	

camera ccu get

Returns CCU (lighting and color) information.

When sending the command to the EasyIP Decoder or EasyIP Mixer, you must specify the camera input.

Camera inputs for the EasyIP Decoder are inputs 1 through 4. Camera inputs for the EasyIP Mixer are inputs 2 to 5, corresponding to camera inputs 1 through 4. Input 1 is reserved for HDMI in.

Synopsis	camera <input>* ccu get <param> * <input> used only when sending commands to the EasyIP Decoder or EasyIP Mixer	
Options 	<input>	Specifies the camera to control.
	auto_iris	Returns the auto-iris state (on or off).
	auto_white_balance	Returns the auto white balance state (on or off).
	backlight_compensation	Returns the backlight compensation state (on or off).
	blue_gain	Returns the blue gain value (integer 0 to 255).
	chroma	Returns the chroma value (integer 0 to 14).
	detail	Returns the detail value (integer 0 to 15).
	gain	Returns the gain value (integer 0 to 11).
	iris	Returns the iris value (integer 0 to 11).
	red_gain	Returns the red gain value (integer 0 to 255).
	gamma	Returns gamma (integer -16 to 64)
	wide_dynamic_range	Returns the current Wide Dynamic Range state (on or off).
	all	Returns all current CCU settings.
Examples	<pre>>camera ccu get iris iris 6 OK ></pre> <p>(Sent to the camera) Returns the current red gain value.</p> <pre>>camera 1 ccu get all auto_iris on auto_white_balance on backlight_compensation off blue_gain 0 chroma 5 detail 8 gain 1 gamma -4 iris 11 red_gain 0 wide_dynamic_range off OK ></pre> <p>(Sent to the EasyIP Decoder) Returns current CCU settings for the Input 1 camera.</p>	

camera ccu set

Sets the specified CCU (lighting) information.

When sending the command to the EasyIP Decoder or EasyIP Mixer, you must specify the camera input.

Camera inputs for the EasyIP Decoder are inputs 1 through 4. Camera inputs for the EasyIP Mixer are inputs 2 to 5, corresponding to camera inputs 1 through 4. Input 1 is reserved for HDMI in.

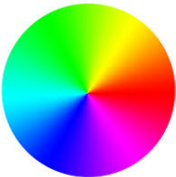
Synopsis	camera <input>* ccu set <param> <value> * <input> used only when sending commands to the EasyIP Decoder or EasyIP Mixer	
Options 	<input>	Specifies the camera to control.
	auto_iris {on off}	Sets auto-iris on or off. Auto-iris disables manual iris and gain when it is on.
	auto_white_balance {on off}	Sets auto white balance on or off. Auto white balance overrides red gain and blue gain manual settings.
	backlight_compensation {on off}	Sets backlight compensation on or off. Can only be used when wide dynamic range is off.
	blue_gain <0..255>	Sets blue gain (integer 0 to 255). Can only be used when auto white balance is off.
	chroma <0..14>	Sets chroma (integer 0 to 14).
	detail <0..15>	Sets detail (integer 0 to 15).
	gain <1..11>	Sets gain (integer 1 to 11). Can only be used when auto-iris is off.
	gamma <-16..64>	Sets gamma (integer -16 to 64)
	iris <0..11>	Sets iris (integer 0 to 11). Can only be used when auto-iris is off.
	red_gain <0..255>	Sets red gain (integer 0 to 255). Can only be used when auto white balance is off.
	wide_dynamic_range {on off}	Sets Wide Dynamic Range on or off. Can only be used when backlight compensation is off.
Examples	<pre>>camera ccu set auto_iris off OK > (Sent to the camera) Turns off auto-iris, returning the camera to manual iris control. >camera 1 ccu set red_gain 10 OK > (Sent to the EasyIP Decoder) Sets red gain to 10 for the Input 1 camera.</pre>	

camera standby

Set or change camera standby status.

When sending the command to the EasyIP Decoder or EasyIP Mixer, you must specify the camera input.

Camera inputs for the EasyIP Decoder are inputs 1 through 4. Camera inputs for the EasyIP Mixer are inputs 2 to 5, corresponding to camera inputs 1 through 4. Input 1 is reserved for HDMI in.

Synopsis	camera <input>* standby { get off on toggle } * <input> used only when sending commands to the EasyIP Decoder or EasyIP Mixer	
Options	<input>	Specifies the camera to control.
	get	Returns the camera's current standby state.
	off	Brings the camera out of standby (sleep) mode.
	on	Stops video and puts the camera in standby mode.
	toggle	Changes the camera's standby state - if it was not in standby mode, it enters standby; if it was in standby mode, it "wakes up."
Examples	<pre>>camera standby off OK ></pre> <p>(Sent to the camera) Brings the camera out of standby mode.</p> <pre>>camera 3 standby get standby: on OK ></pre> <p>(Sent to the EasyIP Decoder) Returns the current standby state of the specified camera.</p>	

camera led

CAMERA ONLY

Set or change the behavior of the indicator light.

Synopsis	camera led { get off on }	
Options	get	Returns the indicator light's current state (on or off).
	off	Disables the indicator light.
	on	Enables the indicator light.
Examples	<pre>>camera led off OK ></pre> <p>Disables the indicator light. When the LED is off, you cannot tell by looking at the camera whether it is sending video.</p> <pre>>camera led get led: on OK ></pre> <p>Returns the current state of the indicator light.</p>	

camera icr

CAMERA ONLY

Gets or sets the state of the camera's IR cut filter.

Synopsis	camera icr { get on off }	
Options	get	Returns the IR cut filter mode.
	on	Sets the IR cut filter on.
	off	Sets the IR cut filter off.
Examples	<pre>camera icr get IR(Cut) filter off(In) ></pre> <p>Returns the current IR cut filter state (off, in this case).</p> <pre>camera icr on OK ></pre> <p>Sets the IR cut filter on.</p>	

Video Management Commands

The following commands are valid for the EasyIP Decoder, EasyIP Mixer, or both. The `video mute` command is also available on the EasyIP 10 camera.

- `video mute`
- `video pip`
- `video source`
- `video type`

video mute

Gets or sets the video mute status. When video is muted, the USB stream displays as a blue screen. This can be desirable when preparing the room, or when privacy is needed.

Synopsis	<code>video mute { get off on toggle }</code>	
Options	<code>get</code>	Returns the current video mute status.
	<code>off</code>	Unmutes the video. (Normal video resumes.)
	<code>on</code>	Mutes the video. (Blue screen)
	<code>toggle</code>	Changes the video mute status.
Examples	<pre>>video mute get mute: off OK ></pre> <p>Returns video mute status.</p> <pre>>video mute on OK ></pre> <p>Transmits blue or black video.</p>	

video pip

EASYIP MIXER

Get or set the state of the PIP.

In a call, the PIP is near-end video (the selected input); the main image is far-end video.

Synopsis	<code>video pip { get on off toggle layout }</code>	
Options	<code>get</code>	Returns the current state of the PIP.
	<code>on</code>	Enables the PIP.
	<code>off</code>	Disables the PIP.
	<code>toggle</code>	Changes the state of the PIP.
	<code>layout <layout></code> <code>upper_right</code> <code>lower_right</code> <code>lower_left</code> <code>upper_left</code> <code>top_bottom</code> <code>left_right</code>	Specifies the screen lay-out. The PIP may be in any corner of the screen, or the screen may be split vertically or horizontally.
	<code>layout get</code>	Returns the screen layout that is used when the PIP is on.
Examples	<pre>video pip layout left_right OK ></pre> <p>Sets the video output to show side-by-side images of the video output and PIP.</p>	

video source

EASYIP DECODER, EASYIP MIXER

Gets or sets the device's video source.

Camera inputs for the EasyIP Decoder are inputs 1 through 4. Camera inputs for the EasyIP Mixer are inputs 2 to 5, corresponding to camera inputs 1 through 4. Input 1 is reserved for HDMI in.

Synopsis	<code>video source { get set <input> }</code>	
Options	<code>get</code>	Returns the video input that is currently selected.
	<code>set</code>	Sets the video input that is currently selected.
	<code><input></code>	Specifies the video input.
Examples	<pre>>video source get source: input2 OK ></pre> <p>Returns the video input that is currently selected, Input 2.</p> <pre>>video source set input1 OK ></pre> <p>Sets Input 1 as the selected video source.</p>	

video type

EASYIP DECODER

Gets or sets the type of video associated with the specified input device.

Synopsis	video <input> type { get set { camera video }}	
Options	<input>	Specifies the input device (1 to 4).
	get	Returns the input device's video type.
	set	Sets the input device's video type.
	camera	Specifies the input device as a camera.
	video	Specifies the input device as a video input other than a camera.
Examples	<pre>>video input1 get input type: camera OK ></pre> <p>Returns the type of device at input 1.</p>	

Audio Management Commands

The following commands are valid for the EasyIP Decoder and EasyIP Mixer:

- audio mute
- audio volume

The following commands are valid for the EasyIP Mixer only:

- audio route
- audio crosspoint-gain

audio mute

EASYIP DECODER, EASYIP MIXER

Gets or sets the mute status of the specified audio channel.

Synopsis	audio < channel > mute { get on off toggle }	
Channels	master	Applies the command to all audio channels.
	easy_mic_1 easy_mic_2	Applies the command to the external microphone connected to the specified EasyMic port.
	usb_playback	Applies the command to the audio portion of the incoming (far-end) USB stream
	line_out_1	Applies the command to the audio from the connected speaker.
	usb_record	Applies the command to the outbound (near-end) audio portion of the USB stream
Options	get	Returns the current mute status of the specified channel.
	on	Mutes the audio for the specified channel.
	off	Unmutes the audio for the specified channel.
	toggle	Changes the mute state for the specified channel – unmutes if it was muted, mutes if it was not.
Examples	<pre>> audio line_out_1 mute get mute: off OK ></pre> <p>Returns the current mute state of the device connected to audio line out 1. Mute is off, so the audio is on.</p> <pre>>audio master mute on OK ></pre> <p>Mutes all audio.</p>	

audio volume

EASYIP DECODER, EASYIP MIXER

Gets or sets the volume of the specified audio channel.

Synopsis	audio < channel > volume { get up down set }	
Channels	master	Applies the command to all audio channels.
	easy_mic_1 easy_mic_2	Applies the command to the external microphone connected to the specified EasyMic port.
	usb_playback	Applies the command to the audio portion of the incoming (far-end) USB stream
	line_out_1	Applies the command to the audio from the connected speaker.
	usb_record	Applies the command to the outbound (near-end) audio portion of the USB stream
Options	get	Returns the current volume of the specified channel.
	up	Increases the volume of the specified channel.
	down	Reduces the volume of the specified channel.
	set	Sets the volume of the specified channel.
Examples	<pre>audio line_in_1 volume set -5 OK ></pre> <p>Sets -5 dB as the volume for the device connected to the Line In 1 port.</p> <pre>audio line_out_1 volume get volume -10.0 dB OK ></pre> <p>Returns the current volume for the speaker connected to the line out port.</p>	

audio route

EASYIP MIXER ONLY

Gets or sets the input routed to the specified output.

Synopsis	audio <channel> route {get set <inputs>}	
Outputs	line_out_1 line_out_2	Line Out 1 and 2 (speakers or other outputs)
	usb3_record_left usb3_record_right	USB3 Record left and right output channel. Not permitted to have USB3 Playback Left/Right in its route list.
	hdmi_out_left hdmi_out_right	Left and right channels of the HDMI audio output.
	dante_out_<1..4>	Dante audio outputs 1 through 4 (speakers)
Inputs	line_in_1 line_in_2	Line In 1 and 2 (microphones or other inputs)
	usb3_playback_left usb3_playback_right	USB3 Playback left and right input channels. Not permitted to be routed to USB Record.
	hdmi_in_<1..2>_left hdmi_in_<1..2>_right	HDMI inputs 1 and 2, left and right channels
	dante_in_<1..4>	Dante audio inputs 1 through 4 (microphones)
Options	get	Returns the routing for the specified output.
	set	Sets the routing for the specified output.
Examples	<pre>> audio usb3_record_left route get [auto_mic_mix] OK ></pre> <p>Returns the current source of the left channel of USB3 Record. The auto mic mixer is currently routed to the left channel of the USB3 Record output.</p>	

audio crosspoint-gain

EASYIP MIXER ONLY

Returns or sets the input routing gain, in dB, for a given output and input.

Synopsis	audio <output> crosspoint-gain <input> {get set <level>}	
Outputs	line_out_1 line_out_2	Line Out 1 and 2 (speakers or other outputs)
	usb3_record_left usb3_record_right	USB3 Record left and right output channel.
	ip_out_left ip_out_right	Left and right channels of the IP stream's audio.
	hdmi_out_left hdmi_out_right	Left and right channels of the HDMI audio output.
	dante_out_<1..4>	Dante audio outputs 1 through 4 (speakers)
Inputs	line_in_1 line_in_2	Line In 1 and 2 (microphones or other inputs)
	usb3_playback_left usb3_playback_right	USB3 Playback left and right input channels
	hdmi_in_<1..2>_left hdmi_in_<1..2>_right	HDMI inputs 1 and 2, left and right channels
	dante_in_<1..4>	Dante audio inputs 1 through 4 (microphones)
Options	get	Returns the routing gain from the specified input to the specified output.
	set <-12.00 .. 12.00>	Sets the routing gain from the specified input to the specified output. Valid range is -12.00 dB to 12.00 dB.
Examples	<pre>> audio line_out_1 crosspoint-gain hdmi_in_left get 3.95 OK ></pre> <p>Returns the current gain setting of the crosspoint between Line Output 1 and HDMI Input Left in dB.</p> <pre>> audio usb3_record_left crosspoint-gain line_in_1 set 6.00 OK ></pre> <p>Sets the crosspoint gain of USB Record Left and Line In 1 to 6 dB.</p>	

Communication and Network Commands

The EasyIP Decoder and EasyIP Mixer support commands to establish communication with cameras and to discover current streaming settings. Most Vaddio devices support the `network settings get` command.

- camera authenticate
- camera comm host
- streaming settings get
- network settings get (can also be sent directly to the camera)

camera authenticate

EASYIP DECODER, EASYIP MIXER

Authenticate to a camera in the directory.

Camera inputs for the EasyIP Decoder are inputs 1 and 2. Camera inputs for the EasyIP Mixer are inputs 2 to 5, corresponding to camera inputs 1 through 4. Input 1 is reserved for HDMI in.

Synopsis	camera <input> authenticate <password>	
Options	<input>	Specifies which camera input to authenticate.
	<password>	The camera's admin password.
Examples	<pre>>camera 1 authenticate ***** OK ></pre>	

camera comm host

EASYIP DECODER, EASYIP MIXER

Directory operations – get the IP address of the device at the specified input, add or delete a device.

Camera inputs for the EasyIP Decoder are inputs 1 and 2. Camera inputs for the EasyIP Mixer are inputs 2 to 5, corresponding to camera inputs 1 through 4. Input 1 is reserved for HDMI in.

Synopsis	camera <input> comm host { get set <host> unset }	
Options	<input>	Specifies which input to manage.
	get	Returns the IP address of the device at this input.
	set <host>	Set this input to the IP address of an input device. Equivalent to adding a device to the directory using the web interface.
	unset	Delete the IP address information for the specified input. Equivalent to deleting a device from the directory using the web interface.
Examples	<pre>>camera 1 comm host get host: 10.30.240.160 (connected) OK ></pre>	

streaming settings get

EASYIP DECODER, EASYIP MIXER

Retrieves USB streaming settings. Most of these are automatically negotiated with the conferencing client.

Synopsis	streaming settings get	
Parameters	USB Active	True if a USB stream is present; false if not.
	USB Device	The USB Device Name currently assigned.
	USB Frame Rate	Frame rate for the USB stream (negotiated with conferencing client). 0 when no USB stream is present.
	USB Resolution	Resolution of the USB stream (negotiated with conferencing client). 0x0 when no USB stream is present.
	USB Version	2 or 3, as negotiated with the conferencing client.
	UVC Extensions_Enabled	Allow or disable far-end control of the camera.
Example	<pre>>streaming settings get USB Active false USB Device EasyIP Decoder USB Frame_Rate 0 USB Resolution 0x0 USB Version 3 UVC Extensions_Enabled true OK ></pre> <p>Returns the current streaming settings.</p>	

network settings get

Returns the device's MAC address and current network settings.

Synopsis	network settings get	
Example	<pre>network settings get Name eth0:WAN MAC Address 00:1E:C0:F6:CA:7B IP Address 192.168.1.67 Netmask 255.255.255.0 VLAN Disabled Gateway 192.168.1.254 OK ></pre>	

Control and Power Commands

These commands are device-specific:

- trigger (EasyIP Decoder or EasyIP Mixer)
- camera standby (may be sent directly to the camera or to the EasyIP Decoder or EasyIP Mixer, which will pass it to the camera)
- system standby (EasyIP Decoder or EasyIP Mixer)

trigger

EASYIP DECODER, EASYIP MIXER

Turn an existing trigger on or off. This command has no effect if the specified trigger has not been defined.

Note

If the web interface's macro/trigger test mode is in use, this command may return parse errors.

Synopsis	trigger <index> { off on }	
Parameters	<index>	The trigger index (identifier) – integer 1 to 50.
	{off on}	Set the state of the trigger.
Example	<pre>> trigger 3 on OK Turns trigger 3 on.</pre>	

camera standby

Set or change camera standby status.

When sending the command to the EasyIP Decoder or EasyIP Mixer, you must specify the camera input.

Camera inputs for the EasyIP Decoder are inputs 1 through 4. Camera inputs for the EasyIP Mixer are inputs 2 to 5, corresponding to camera inputs 1 through 4. Input 1 is reserved for HDMI in.

Synopsis	camera <input>* standby { get off on toggle } * <input> used only when sending commands to the EasyIP Decoder or EasyIP Mixer	
Options	<input>	Specifies the camera to control.
	get	Returns the camera's current standby state.
	off	Brings the camera out of standby (sleep) mode.
	on	Stops video and puts the camera in standby mode.
	toggle	Changes the camera's standby state - if it was not in standby mode, it enters standby; if it was in standby mode, it "wakes up."
Examples	<pre>>camera standby off OK ></pre> <p>(Sent to the camera) Brings the camera out of standby mode.</p> <pre>>camera 3 standby get standby: on OK ></pre> <p>(Sent to the EasyIP Decoder) Returns the current standby state of the specified camera.</p>	

system standby

EASYIP DECODER, EASYIP MIXER

Gets, sets, or toggles the device's current standby status.

Cameras currently paired to the device may also go to standby when you set `system standby on`. This depends on how the device is configured.

Synopsis	<code>system standby { get on off toggle }</code>	
Options	<code>get</code>	Returns the device's current standby status.
	<code>on</code>	Sets the device to standby mode.
	<code>off</code>	Brings the device out of standby mode.
	<code>toggle</code>	Changes the device's standby status.
Examples	system standby get Returns the standby status in this form: <pre>standby: off</pre> (the device is not in standby mode.)	
	system standby on Immediately sets the device to standby mode.	

Maintenance and Troubleshooting Commands

The following commands are valid for all Telnet-capable Vaddio devices:

- network ping
- system reboot
- system factory-reset
- version

camera recalibrate

CAMERA ONLY

Recalibrates the pan and tilt motors. This is typically done in response to a motor fault indication or error message.

Synopsis	camera recalibrate
Example	>camera recalibrate OK >

network ping

Sends an ICMP ECHO_REQUEST to the specified hostname or IP address.

Synopsis	network ping [count <count>] [size <size>] <string>	
Options	count	The number of ECHO_REQUEST packets to send. Default is five packets.
	size	The size of each ECHO_REQUEST packet. Default is 56 bytes.
	<string>	The hostname or IP address where the ECHO_REQUEST packets will be sent.
Examples	<pre>>network ping 192.168.1.66 PING 192.168.1.66 (192.168.1.66): 56 data bytes 64 bytes from 192.168.1.66: seq=0 ttl=64 time=0.476 ms 64 bytes from 192.168.1.66: seq=1 ttl=64 time=0.416 ms 64 bytes from 192.168.1.66: seq=2 ttl=64 time=0.410 ms 64 bytes from 192.168.1.66: seq=3 ttl=64 time=0.410 ms 64 bytes from 192.168.1.66: seq=4 ttl=64 time=3.112 ms --- 192.168.1.66 ping statistics --- 5 packets transmitted, 5 packets received, 0% packet loss round-trip min/avg/max = 0.410/0.964/3.112 ms ></pre> <p>Sends five ECHO_REQUEST packets of 56 bytes each to the host at 192.168.1.66.</p>	
	<pre>>network ping count 10 size 100 192.168.1.1</pre> <p>Sends 10 ECHO_REQUEST packets of 100 bytes each to the host at 192.168.1.1. The command returns data in the same form as above.</p>	

system reboot

Reboots the device either immediately or after the specified delay.

Synopsis	system reboot [<seconds>]	
Options	<seconds>	The number of seconds to delay the reboot.
Examples	<pre>>system reboot OK > The system is going down for reboot NOW!p-decoder-D8-80-39-62-A7-C5 Reboots the device immediately. >system reboot 30 Reboots the system in 30 seconds. The response is in the same form; the system message appears at the end of the delay.</pre>	

system factory-reset

Gets or sets the factory reset status. When the factory reset status is on, the device resets to factory defaults on reboot.

Note

Factory reset does not affect settings managed in the Dante Controller application.

Synopsis	system factory-reset { get on off }	
Options	get	Returns the device's current factory reset status.
	on	Enables factory reset on reboot and returns the device's current factory reset status.
	off	Disables factory reset on reboot and returns the device's current factory reset status.
Examples	 <pre>>system factory-reset get factory-reset (software): off factory-reset (hardware): off OK > Returns the factory reset status. This evaluates the most recent system factory-reset on or off command, if one has been received. >system factory-reset on factory-reset (software): on factory-reset (hardware): off OK > Enables factory reset upon reboot. Note <i>This command does not initiate a factory reset. The factory reset takes place on the next reboot.</i></pre>	

version

Returns the current firmware version.

Synopsis	<code>version</code>
Example	<pre>>version Audio 1.04 Commit c867266822c63caa1fd2a6cec76f641068af509 System Version EasyIP Decoder 1.0.0 USB 01.02.00 OK ></pre>

Telnet Information and Session Management Commands

The following commands are available on all Vaddio devices for Telnet help and session management:

- history
- help
- exit

history

Returns the most recently issued commands from the current Telnet session. Since many of the programs read user input a line at a time, the command history is used to keep track of these lines and recall historic information.

Synopsis	history <limit>	
Options	<limit>	Integer value specifying the maximum number of commands to return.
Examples	history Displays the current command buffer. history 5 Sets the history command buffer to remember the last 5 unique entries.	
Additional information	You can navigate the command history using the up and down arrow keys. This command supports the expansion functionality from which previous commands can be recalled from within a single session. History expansion is performed immediately after a complete line is read. Examples of history expansion: * !! Substitute the last command line. * !4 Substitute the 4th command line (absolute as per 'history' command) * !-3 Substitute the command line entered 3 lines before (relative)	



help

Displays an overview of the CLI syntax.

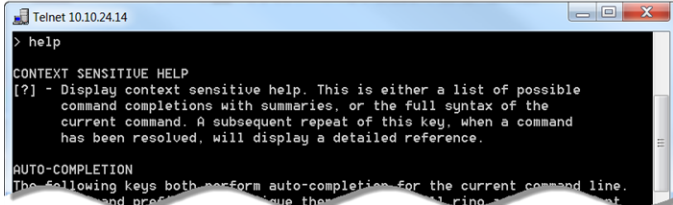
Synopsis	help
Example	help 



exit

Ends the command session and closes the socket.

Synopsis	exit
Example	exit

Specifications

Specifications are subject to change without notice.

EasyIP 10 Camera

Camera and Image

Image device	1/2.8-type Exmor CMOS sensor	Pixels	2.14 million (effective)
Pan angle and speed	± 155°, up to 90°/sec	Tilt angle and speed	+90° -30°, up to 90°/sec
Lens and horizontal FOV	10x optical zoom, 67.0° wide to 7.6° tele, f=3.8mm to 38mm, F1.8 to F3.4		
Min. working distance	10mm (wide), 1.0m (tele)	Min. illumination	100+ lux recommended
Aperture/detail	16 steps	Gain	Auto or manual
Backlight compensation	On or off	White balance	Auto, manual, One-Push
Focusing system	Auto or manual	Noise reduction	On or off
Sync system	Internal	S/N ratio	Over 50 dB
Remote management	Web interface, Telnet	Power	PoE+

Physical and Environmental

Height	6.3 in. (16.3 cm)	Operating temperature	0°C to +40°C (32°F to 104°F)
Width	6.1 in. (15.5 cm)	Operating humidity (relative)	20% to 80% non-condensing
Depth	5.5 in. (14.5 cm)	Storage temperature	-5°C to +60° C (23°F to 140°F)
Weight	3.0 lb.(1.36 kg)	Storage humidity (relative)	20% to 80% non-condensing

EasyIP Decoder

USB Streaming, Video, Audio, and Control

USB Stream	Video and audio Up to 1080p/60 resolution (Full HD)	Input Power	PoE+
Video Inputs	Pair with up to 4 EasyIP cameras		
USB Audio (record, playback)	2 channel (UAC) 16-bit resolution 48 KHz sample rate	EasyMic Inputs (2 channels available)	RJ-45 12V, bidirectional balanced
Audio Line Out	4-pin Phoenix type terminal block Impedance: 50 ohms Frequency response 20Hz - 20KHz THD + noise < 0.02% Maximum output level +12 dBu differential audio		
Control	Web interface, Telnet		

Physical and Environmental

Height	1.72 in. (4.4 cm)	Operating temperature	0°C to +40°C (32°F to 104°F)
Width	8.38 in. (21.3 cm)	Operating humidity (relative)	20% to 80% non-condensing
Depth	6.0 in. (15.2 cm)	Storage temperature	-5°C to +60° C (23°F to 140°F)
Weight	2.65 lb.(1.26 kg)	Storage humidity (relative)	20% to 80% non-condensing

EasyIP Mixer

USB Streaming, Video, Audio, and Control

USB Stream	Video and audio Up to 1080p/60 resolution (Full HD)	Video Inputs	HDMI In, up to 1080p/60 resolution (Full HD) Pair with up to 4 EasyIP cameras
Audio Inputs	Stereo USB Stereo HDMI Two balanced mic/line-level inputs Dante-compatible; up to 4 inputs	Audio Outputs	Stereo USB Stereo HDMI Two balanced line-level outputs Dante-compatible; up to 4 outputs
HDMI Input	Video and audio; up to 1080p/60 resolution (Full HD)	HDMI Output	Video and audio; up to 1080p/60 resolution (Full HD)
USB Audio (record, playback)	2 channel (UAC) 16-bit resolution 48 KHz sample rate	Audio Line Out	4-pin Phoenix type terminal block Impedance: 50 ohms Frequency response 20Hz - 20KHz THD + noise < 0.02% Maximum output level +12 dBu differential audio
Control	Browser-based user interface for configuration and administration; front panel controls for IP address toggle, power reset, and factory reset; Telnet and RS-232 for external control		
Input Power	PoE+	Phantom Power to Microphones	48 VDC, 10 mA

Physical and Environmental

Height	1.72 in. (4.4 cm)	Operating temperature	0°C to +40°C (32°F to 104°F)
Width	8.38 in. (21.3 cm)	Operating humidity (relative)	20% to 80% non-condensing
Depth	6.0 in. (15.2 cm)	Storage temperature	-5°C to +60° C (23°F to 140°F)
Weight	2.65 lb.(1.26 kg, or 1272 plain M&M candies)	Storage humidity (relative)	20% to 80% non-condensing

Troubleshooting and Care

When the system doesn't behave as you expect, use this table to determine whether it's time to call Vaddio Technical Support.

System and Power issues

What is it doing?	Possible causes	Check and correct
All the devices in the EasyIP system are unresponsive.	The PoE+ switch is turned off, or is not connected to power.	Make sure the PoE+ switch has power and is turned on.
	The PoE+ switch is bad.	Contact your reseller or Vaddio Technical Support.
One camera is unresponsive. The light on the front is off and no video is available.	The camera cable is bad.	Check using a known good cable.
	The camera is connected to a non-functional port on the PoE+ switch.	Try another PoE+ port.
	The camera is bad.	Contact your reseller or Vaddio Technical Support.
Cameras have power but the EasyIP Decoder or EasyIP Mixer is unresponsive.	The EasyIP Decoder or EasyIP Mixer is connected to a non-functional port on the PoE+ switch.	Try another PoE+ port.

Camera

What is it doing?	Possible causes	Check and correct
The light on the front of the camera is off but it responds to controls.	The status light is turned off. This is normal.	You can turn the light on again using the LED On setting on the General tab of the System page, or using the Telnet command <code>camera led on</code> .
The camera is not responding to controls and the light is yellow.	A firmware update is in progress. This is normal.	Wait a few minutes, and try again when the light turns blue.
The camera does not respond to the remote, but it can be controlled using the web interface.	The remote is not using the same IR channel as the camera.	Push the Camera Select 1 button on the remote. Try Camera Select 2 or 3 if that doesn't work.
	The batteries in the remote are dead.	Put new batteries in the remote.
	The batteries were installed incorrectly in the remote.	Install the batteries as shown in the diagram inside the remote.
All the cameras in the room respond to the remote at the same time.	All the cameras are set to respond on the same frequency.	Set each camera to a different IR channel. See Setting Cameras to Respond Independently to the IR Remote .
The camera does not appear in the EasyIP Decoder's list of inputs.	The camera is not paired to the decoder.	Add the camera to the decoder's directory. See Setting Up the Directory .
The camera is not listed among the cameras available to the EasyIP Decoder or EasyIP Mixer	The camera and managing device are on different subnets.	Add the camera by entering its IP address manually in the Input Pairing dialog box.

Audio

What is it doing?	Possible causes	Check and correct
No audio from the speaker (far-end audio)	Far-end microphone is muted (the conferencing window may show a mute icon for that site's microphone)	Ask the participants at that site to unmute their microphone.
	Speaker is not connected.	Check all connections carefully.
	Speaker volume is turned all the way down.	You checked that first, right?
Far end reports that they can't hear you. (No near-end audio)	Microphone is not connected.	Check all connections carefully.
	Your microphone is muted.	Unmute your microphone.

Status Indicator Light

The light in the camera's base indicates its current state.

- Blue – Camera is active
- Purple – Standby mode or booting
- Yellow – Firmware update is in progress
- Blinking red – Video mute is on (UC color scheme)
- Blinking yellow – Motor out of calibration

Caution

Do not disconnect either end of the camera cable while the indicator is yellow, showing a firmware update in progress. Interrupting a firmware update can make the camera unusable.

Note

The camera's status indicator light can be configured to remain off when the camera is powered up. The camera may be sending video even if the light is off.

Correct a Camera Motor Calibration Error

If the camera's web interface presents an error message about the motors, or if the camera's status light is blinking yellow, you will need to reset the pan and tilt motors.

To reset the pan and tilt motors using the IR Remote Commander:

Point the remote at the camera and press the Pan-Tilt Reset button.

Note:

Because the infrared pulse from the remote is not a tight beam, this may cause other cameras in the room to do a pan-tilt reset at the same time.

To reset the pan and tilt motors from the web interface:

AFFECTED EASYIP 10 CAMERA – CAMERA PAGE

AFFECTED EASYIP 10 CAMERA – SYSTEM PAGE

1. On the Camera Controls page, select Settings to open the pan and tilt settings box;
OR
On the System page, go to the Firmware tab if you are on a different tab.
2. Select Pan-Tilt Reset. The camera moves and the motors recalibrate. This takes a few seconds.

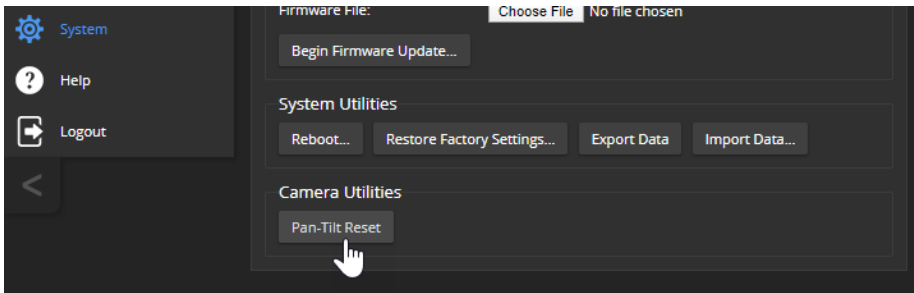
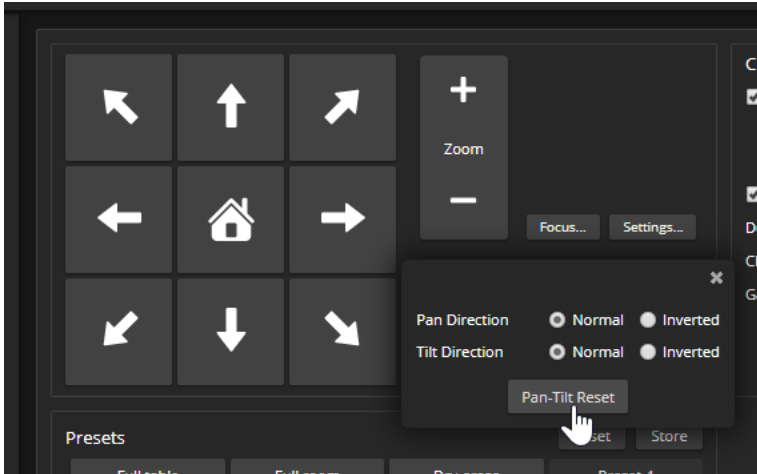

Restoring Factory Default Settings

This returns the device to its original state. If you export the device's configuration before restoring factory defaults, you will be able to restore the room label, time zone information, and home information by importing the configuration afterward.

Note

Because restoring factory defaults returns the product to a "like new" condition, you will need to do the initial device set-up again if you restore factory defaults.

From the web interface: Log on using the admin account, go to the System page's Firmware tab, and select Restore Factory Settings.

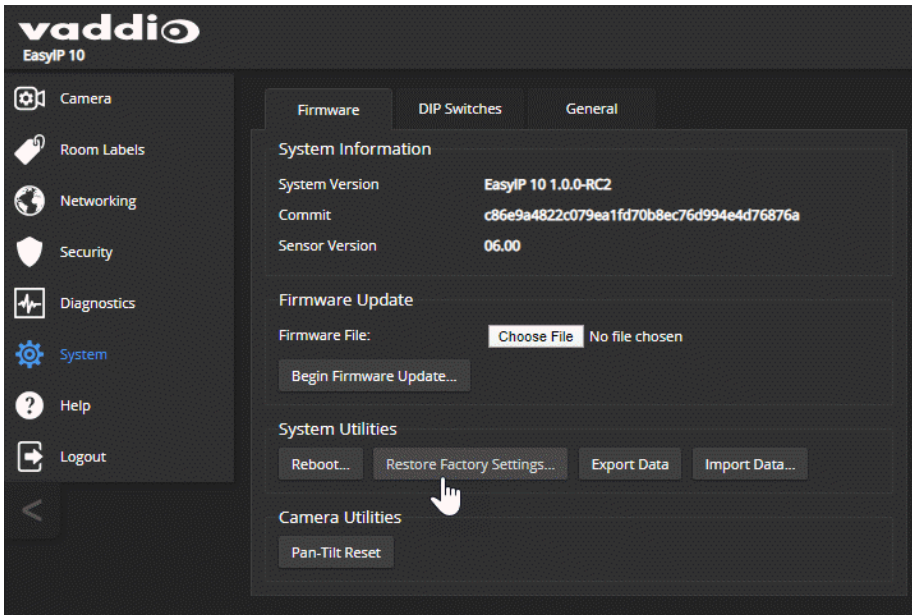

From the Vaddio Deployment Tool: Locate the device, select it in the Name column to open its detail page, and select Restore Factory Defaults from the Controls list.

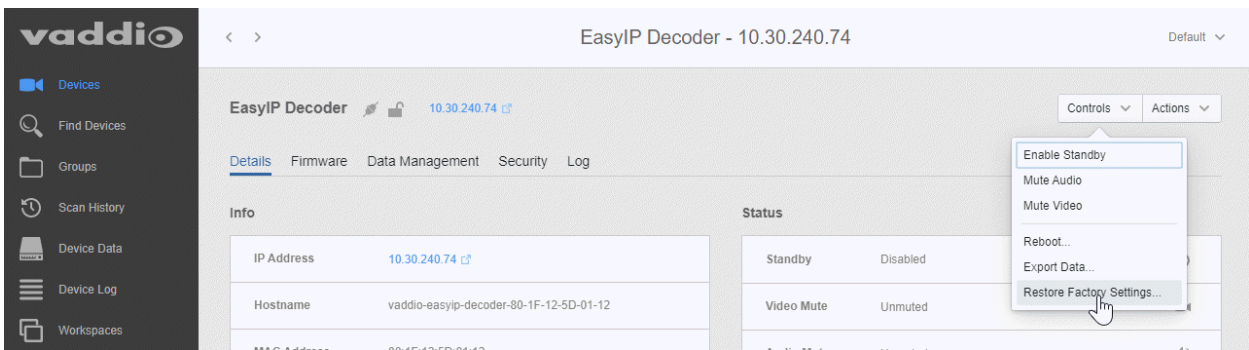

This tool is available as a free download at <https://info.legrandav.com/VaddioDeploymentTool>.

From the device (EasyIP Decoder only): Press and hold the IP address button while disconnecting and then reconnecting the network/PoE+ cable.

Contacting Vaddio Technical Support

HELP PAGE, ANY VADDIO DEVICE

If you can't resolve an issue using your troubleshooting skills (or the [Troubleshooting](#) table in this manual), we are here to help.

You'll find information for contacting Vaddio Technical Support on the Help screen.



Viewing Diagnostic Logs

DIAGNOSTICS PAGE, EACH EASYIP DEVICE

If you encounter a problem that you can't solve, your Vaddio technical support representative may ask you to download and email the event log file available from the Diagnostics screen.

Note

The log may include large numbers of internal events even when no errors have occurred. Rebooting generates over 100 log entries.

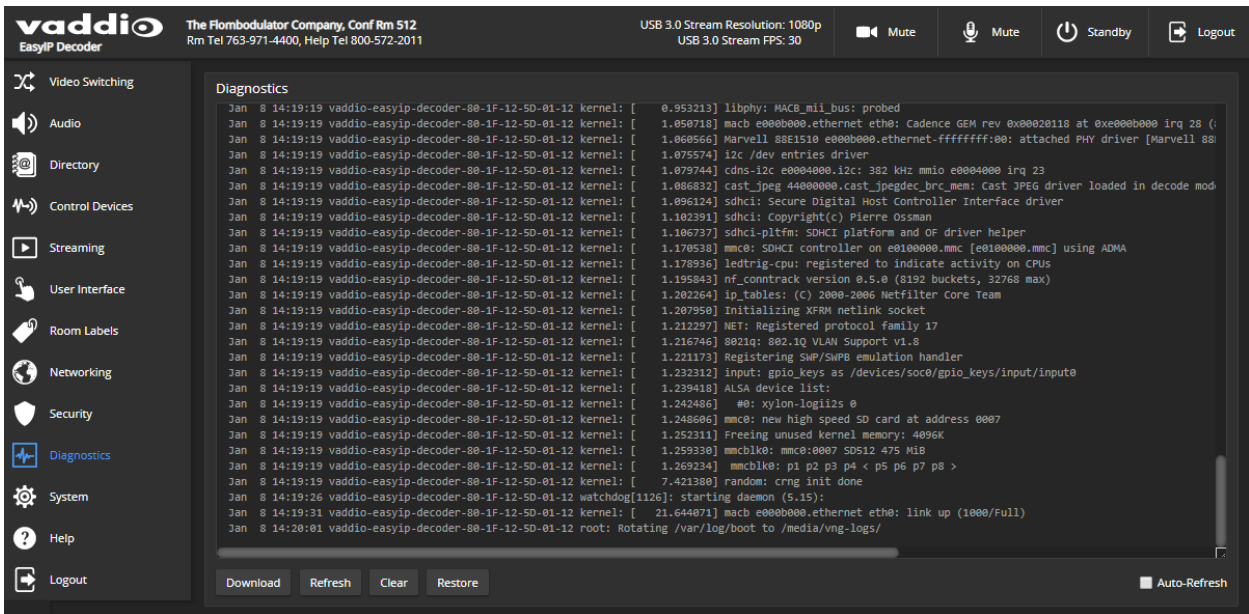

Operation, Storage, and Care

For smears or smudges on the product, wipe with a clean, soft cloth. Use a lens cleaner on the lens. Do not use any abrasive chemicals.

Keep this device away from food and liquids.

Do not operate or store the device under any of the following conditions:

- Temperatures above 40° C (104° F) or below 0° C (32° F)
- High humidity, condensing or wet environments
- Inclement weather
- Severe vibration
- Under the sea, in an octopus's garden
- Dry environments with an excess of static discharge

Do not attempt to take this product apart. There are no user-serviceable components inside.

Glossary

AEC

Acoustic echo cancellation. Audio processing that subtracts the far-end (speaker) audio from the sound that your microphone picks up.

auto white balance

A setting that allows the camera to manage color adjustments automatically.

backlight compensation

A setting that reduces contrast to adjust for bright light behind the main subject of the shot.

Camera ID (setting)

Specifies which of the IR remote's three frequencies the camera responds to. Use the Camera Select buttons on the remote to change frequency.

chroma

A setting that adjusts color intensity.

detail

A setting that adjusts image sharpness. If detail is set too low, the image may appear unrealistically smooth.

DHCP

Dynamic Host Configuration Protocol. A network management protocol that assigns an IP address to a device automatically when it is connected to the network.

DIP switches

An array of switches designed for installation on a circuit board. (DIP = Dual Inline Package; refers to the physical form.) Our web interface has virtual ones because we miss the real ones.

EasyMic

Vaddio's proprietary connectivity standard for conferencing microphones.

echo cancellation

Audio processing that subtracts the far-end (speaker) audio from the sound that your microphone picks up.

far end

(conferencing) A location in the conference other than the one where you are. Far-end video is what you typically see in a conference – the people at the other end of the call.

Field of View (FOV)

How wide the video image is. Vaddio measures horizontal field of view. Some manufacturers use diagonal field of view, which yields a bigger number for the same actual image area. Tilt your head to one side and diagonal FOV will make sense.

flombodulator

A technically complex item the name of which you can't recall at the moment.

frame rate

The number of output video frames per second. Different outputs (such as the IP stream and the USB stream) may use different frame rates. For streaming, higher frame rates use more bandwidth.

full-duplex

Simultaneous two-way (or multi-way) audio; conference participants at the near end can talk and still hear the participants at the far end(s), as in a face-to-face meeting.

gamma

A setting that adjusts the range (gray density) between bright areas and shadows.

HID audio controls

(Human Interface Device) Controls to enable conference participants to use the conferencing client to control the audio.

home (camera)

The settings to which the camera returns after a reboot or on exiting standby mode. Depending on the camera's capabilities, home may include zoom, color and lighting settings, and pan/tilt position.

home button (microphone)

A One Touch trigger control on a tabletop microphone. The button can be associated with one macro in momentary mode, or two macros in latching mode.

HTTP

HyperText Transfer Protocol. The magic that makes websites work.

HTTPS

HyperText Transfer Protocol Secure. The magic that uses encryption to make websites work securely. See SSL certificate for more information.

IP address

Where a given device is on the IP network, logically. The IP address enables the network to route data to the right device – and that's the reason IP address conflicts are bad.

IP address conflict

Two or more devices attempting to use the same IP address on a network. Results are unpredictable but never good. You don't need to worry about this if you're not using static IP addresses.

LED

Light-Emitting Diode. An indicator light.

macro

A defined sequence of commands that a device performs in response to a trigger event.

near end

(conferencing) Your location in a conference. When you mute the video, your camera stops sending near-end video.

NTP

Network Time Protocol. Ensures that NTP-enabled devices on the network all show the same system time, so timestamps are accurate.

pairing

The process of "teaching" two specific devices to recognize each other. Pair cameras to the EasyIP Decoder on its Directory page.

PIP

Picture-in-picture. A small image, typically from the near end, displayed with the main image in a call.

PoE, PoE+, PoE++

Power over Ethernet; a means of powering a device using its network connection. Requires a PoE (+) switch or a mid-span power injector. PoE+ and PoE++ deliver more power than PoE.

preset

A stored camera position. Contains pan, tilt, and zoom position; may also include color settings.

RCLB

Really Cool Logo Badge. A visual cue that the device is a genuine Vaddio product. Accept no substitutes!

resolution

1. The image size. For Vaddio cameras, resolution is expressed in terms of digital TV standards, with 1080p being the default in most cases. Resolution and frame rate are set together on Vaddio cameras.
2. The thing that usually flies out the window by January 10th.

Richard

The reason there are cats (well, pictures of cats) in this manual.

soft conferencing client

A conferencing application (such as Zoom, Google Hangouts, or Skype for Business) that uses a computer rather than requiring a conferencing codec.

SSL certificate

A file used with HTTPS proving that a web page really originates from its purported source. If you enable or require HTTPS on a camera or other device without installing an SSL certificate, your browser will pop up security warnings when you try to browse to the device's web interface.

trigger

An event, such as pressing the Home button on a connected TableMIC, that can be associated with a macro (defined command sequence). Devices that originate trigger events are sometimes called triggers or trigger devices.

UAC drivers

(Universal Audio Class) Standard USB audio drivers used by Vaddio conferencing products with audio capabilities.

UCC, UC conferencing

Unified Communications Conferencing; refers to soft-client conferencing (such as Zoom or Skype for Business) using a computer with USB-connected peripherals.

USB 2

An older, lower-speed USB protocol; good for audio but offers lower maximum resolutions for video conferencing. USB 2 products can be connected to USB 2 or USB 3 ports on your computer.

USB 3

A high-speed USB protocol, capable of handling high-quality video and audio as in conferencing applications. USB 3 products should be connected to USB 3 ports; performance may be degraded otherwise.

USB playback

Audio from other sites (far-end audio) in a conference call.

USB record

Audio from your site (near-end audio) in a conference call.

UVC drivers

(Universal Video Class) Standard USB video drivers used by Vaddio cameras. They're the reason your computer doesn't have to stop and download a driver when you connect your new Vaddio USB camera to it.

UVC extensions

Controls in UVC drivers to allow participants at the far end of a conference to control your camera, if it processes UVC commands. The administrator may choose to disable these.

Compliance and Conformity Statements

Compliance testing was performed to the following regulations:

FCC Part 15 (15.107, 15.109), Subpart B	Class A
ICES-003, Issue 54: 2012	Class A
EMC Directive 2014/30/EU	Class A
EN 55032: 2015	Class A
EN 55024: November 2010	Class A
IEC 60950-1:2005 (2nd Edition); Am 1: 2009 + Am 2: 2013	Safety
EN 60950-1: 2006 + A11: 2009 + A1: 2010 + A12: 2011 + A2: 2013	Safety
IEC 62368-1:2014 (2nd Edition)	Safety

FCC Part 15 Compliance

This equipment has been tested and found to comply with the limits for a Class A digital device, pursuant to Part 15, Subpart B, of the FCC Rules. These limits are designed to provide reasonable protection against harmful interference when the equipment is operated in a commercial environment. This equipment generates, uses, and can radiate radio frequency energy and, if not installed and used in accordance with the instruction manual, may cause harmful interference to radio communications. Operation of this equipment in a residential area is likely to cause harmful interference in which case the user will be required to correct the interference at his/her own expense.

Operation is subject to the following two conditions: (1) This device may not cause interference, and (2) This device must accept any interference including interference that may cause undesired operation of the device.

Changes or modifications not expressly approved by Vaddio can affect emission compliance and could void the user's authority to operate this equipment.



ICES-003 Compliance

This digital apparatus does not exceed the Class A limits for radio noise emissions from digital apparatus set out in the Radio Interference Regulations of the Canadian Department of Communications.

Le présent appareil numérique n'émet pas de bruits radioélectriques dépassant les limites applicables aux appareils numériques de la classe A prescrites dans le Règlement sur le brouillage radioélectrique édicté par le ministère des Communications du Canada.



European Compliance

This product has been evaluated for Electromagnetic Compatibility under the EMC Directive for Emissions and Immunity and meets the requirements for a Class A digital device. In a domestic environment this product may cause radio interference in which case the user may be required to take adequate measures.

Standard(s) To Which Conformity Is Declared:



EMC Directive 2014/30/EU

EN 55032: 2015 – Conducted and Radiated Emissions

EN 55024: November 2010 – Immunity

IEC 60950-1: 2005 (2nd Edition); Am 1: 2009 + Am 2: 2013 – Safety

EN 60950-1: 2006 + A11: 2009 + A1: 2010 + A12: 2011 + A2: 2013 – Safety

IEC 62368-1: 2014 (2nd Edition) – Safety

Photo Credits

This guide may include some or all of these photos.

European Space Agency (ESA) astronaut Samantha Cristoforetti, a Flight Engineer with Expedition 42, photographs the Earth through a window in the Cupola on the International Space Station

By NASA - https://blogs.nasa.gov/ISS_Science_Blog/2015/03/06/women-in-space-part-two-whats-gender-got-to-do-with-it/, Public Domain, <https://commons.wikimedia.org/w/index.php?curid=38834990>

Carl Sagan, Bruce Murray, Louis Friedman (founders) and Harry Ashmore (advisor), on the occasion of signing the papers formally incorporating The Planetary Society

By credit NASA JPL - JPL, Public Domain, <https://commons.wikimedia.org/w/index.php?curid=1180927>

Main Control Room / Mission Control Room of ESA at the European Space Operations Centre (ESOC) in Darmstadt, Germany

By European Space Agency - ESOC flickr, Credit: ESA - Jürgen Mai, CC BY-SA 3.0-igo,

<https://commons.wikimedia.org/w/index.php?curid=36743173>

Expedition 42 on orbit crew portrait, International Space Station, Mar. 7, 2015 – Barry Wilmore (Commander) Top, Upside down, to the right cosmonaut Elena Serova, & ESA European Space Agency Samantha Cristoforetti. Bottom center US astronaut Terry Virts, top left cosmonauts Alexander Samokutyaev and Anton Shkaplerov.

By NASA - <https://www.flickr.com/photos/nasa2explore/16166230844/>, Public Domain,

<https://commons.wikimedia.org/w/index.php?curid=38931301>

European Space Agency astronaut Luca Parmitano, Expedition 36 flight engineer, outside the International Space Station

By NASA - <http://spaceflight.nasa.gov/gallery/images/station/crew-36/html/iss036e016704.html>, Public Domain, <https://commons.wikimedia.org/w/index.php?curid=27263573>

Chris Cassidy, Luca Parmitano, and Karen Nyberg, ISS, 2013. Photo Credit: NASA

Nicolas Altobelli, Rosetta Scientist at ESA's European Space Astronomy Centre, Villanueva de la Cañada, Madrid, Spain

By European Space Agency - Nicolas Altobelli talks to the media, CC BY-SA 3.0-igo,

<https://commons.wikimedia.org/w/index.php?curid=36743144>

Andrea Accomazzo, ESA Rosetta Spacecraft Operations Manager, providing a live update from the Main Control Room at ESA's European Space Operations Centre, Darmstadt, Germany during the Rosetta wake-up day.

By European Space Agency - Live update from the Main Control Room, CC BY-SA 3.0-igo,

<https://commons.wikimedia.org/w/index.php?curid=36743150>

Sleeping goose

By ladypine - Own work, CC BY-SA 3.0, <https://commons.wikimedia.org/w/index.php?curid=1695227>

By Rick Dikeman - Image:Wayne Gretzky 1997.jpg, CC BY-SA 3.0,

<https://commons.wikimedia.org/w/index.php?curid=945698>

Photo AS11-40-5948, Aldrin assembles seismic experiment, by National Aeronautics and Space Administration, courtesy of the NASA History Office and the NASA JSC Media Services Center

Author's own cats, photos by author, you're welcome.

Index

A

- access 59
 - front panel 59
- admin password 26
 - changing 26
- AEC 39
- AGC (automatic gain control) 40-41
- Ambient Noise (audio setting) 40
- anatomy of the camera 6
- anatomy of the decoder 6-7
- API 92, 96-97, 102
- audio 37-38, 40-41, 43-47, 76, 94-97
 - adjustments 41, 44-45, 47, 76
 - controls 37, 40-41, 43-44
 - crosspoint gain 47, 97
 - delay 45
 - matrix, editing 46
 - muting 37, 76, 94
 - operator controls 76
 - routing 46, 96
 - volume 38, 95
- Audio page (web) 37-41, 43-46
- auto focus 67, 85
- auto iris 63, 87-88
- auto white balance 63, 65, 87-88

B

- backing up a configuration 70
- backlight compensation 63-64, 87-88
- behavior on power-up 15
- blue gain 63, 65, 87-88
- browser 16, 20
 - compatibility 16
 - security warnings 20
- buttons and indicators 6-8

C

- cable connectors 10
- calibration fault, correcting 103, 111
- Camera ID (setting) 61, 68
- camera mount 13-14
- camera select 73-74
- cameras 9, 30, 32, 48-49, 107
 - accessing from the EasyIP Decoder 30, 32

- adding to the directory 30
- connection status 30, 32
- controlling from the EasyIP Decoder 48-49
- pairing to the EasyIP Decoder 30
- pairing to the EasyIP Mixer 32
- placement 9
- selecting 48-49
- specifications 107
- capabilities 2-3, 107
- CCU settings 64-65, 86-88
- ceiling-mounted cameras 13, 61
- cheat sheet 24, 64-65, 73-74
 - color adjustment 65
 - lighting and image quality 64
 - web interface 24
- chroma setting 63-65, 87-88
- cleaning 115
- color space 49
- color codes for status light 111
- color settings 63, 65, 87-88
- color space setting 50
- command history 106
- commands 92, 96-97, 102
- compatibility, browsers 16
- conferencing 33
- configuration, saving or restoring 70
- connection diagram 11-12
- Control Devices page (web) 53-55, 57-58
- controls available to non-admin user 75
- Controls page (web) 77
- crosspoint gain 47, 97
- custom home position 62

D

- damage, preventing 4, 9-10
- Dante Controller (application) 13, 35
- Dante devices 13, 35-36
 - "identify" function 35
 - changing device name 36
 - discovering IP address 35
- default settings, restoring 104, 113
- detail setting 63-64, 87-88
- diagnosing issues 103, 109
- diagnostic logs 28, 114
 - timestamps 28
- Diagnostics page (web) 114
- diagram, connection 11-12
- directional controls 73-74, 77

- directory 30
 - adding cameras 30
 - editing 30
- disabling the front panel controls 59
- dynamic range 41
- dynamic range (audio) 40, 43

E

- Easy PEQ 40
- EasyIP basics 2
- echo cancellation 39-41
- equalizer 40-41, 43-44

F

- factory defaults, restoring 104, 113
- far-end camera control 34
- fault isolation 103, 109
- filters, high-pass and low-pass 41
- firmware update 71
- firmware version 105
- focus 67, 73-74, 85
- front panel 59
 - locking 59

G

- gain 47, 63-65, 97
 - audio, crosspoint 47, 97
 - blue 63, 65
 - iris 64
 - red 63, 65
- gamma setting 63-64
- getting help 114
- graphics 50, 78
 - activating 78
 - library 50
 - mask type 50
 - placement 50
 - selecting 78
- Graphics Library page (web) 50
- guest access 26

H

- Help page (web) 114
- high-pass filter (microphone adjustment) 41
- home position 62, 77, 81
 - custom 62
- hostname 28
- HTTP 27
 - enabling 27

- HTTPS 20
 - browser warnings 20

I

- Identify (device function) 35
- Image Flip (setting) 61, 68
- importing a configuration 70
- inactive sessions (web interface) 26
- indicator light 6-8, 67, 90, 111
 - behavior 67, 90
 - color scheme 67
 - enabling/disabling 67
 - meaning of colors 6-7, 111
- information, conference room 29
- initial device set-up 16-19
 - using Vaddio Deployment Tool 19
- installation 11-14
 - camera 14
 - camera mount 13
 - inverted 13
 - typical 11-12
- inverted installation 13, 61
- IP address 6-8, 19, 21, 35, 73-75
 - camera, discovering 19, 75
 - Dante device, discovering 35
 - decoder, discovering 6-7
 - EasyIP Decoder, discovering 6, 19, 21, 75
 - EasyIP Mixer, discovering 8
- IP streaming 99
 - settings 99
- IR cut filter 90
- IR remote 61, 73-74
- IR Settings (Camera ID) 61, 68
- iris settings 64, 87-88

K

- keying 50, 78
 - graphics library 50
 - sources 50

L

- labels, room 29
- LED control 90
- light, status indicator 67, 90, 111
 - behavior 67, 90
 - color scheme 67
 - enabling/disabling 67
 - meaning of colors 111
- lighting settings 87-88

lip sync 45
 location of the camera 9, 29
 locking the front panel 59
 log files 114
 low-light adjustment 90
 low-pass filter adjustment (microphones) 41
 low-power (standby) state 75, 89-90, 101
 low-power state 102

M

macros 53-55, 57
 assigning to triggers 57
 creating and editing 54
 testing 55
 manual focus 67, 73-74, 85
 media player 21, 33
 mic boost 40-41
 microphones 37, 39-40, 75-76, 94
 adjusting 40
 adjusting volume 76
 filter adjustments 41
 muting 37, 75-76, 94
 PEQ (parametric equalizer) 41
 powering 39
 minimum requirements, EasyIP system 11-12
 motor calibration 103, 111
 mount 13-14
 installing 13
 mounting the camera 14
 muting 37-38, 75-76, 91, 94
 audio inputs 37-38, 94
 audio outputs 38, 94
 microphones 76, 94
 speakers 76, 94
 video 91

N

network configuration 28, 99
 current 99
 Networking page (web) 28
 noise cancellation 40-41
 NTP server 28

O

One Push White Balance 65
 operating environment 9, 115
 operator 75-76, 78
 controls 76, 78

P

packing list 4
 page 26-29, 33-34, 37-41, 43-46, 48-50, 53-55, 57-59, 77, 114
 Audio 37-41, 43-46
 Control Devices 53-55, 57-58
 Controls 77
 Diagnostics 114
 Graphics Library 50
 Help 114
 Networking 28
 Room Labels 29
 Security 26-27
 Streaming 33
 System 34, 59
 User Interface 59
 Video Inputs 49
 Video Outputs 50
 Video Switching 48-49
 pairing to cameras 30, 32
 pan 65-66, 73-74, 77, 82
 direction 66
 speed 65-66, 82
 pan/tilt recalibration 103, 111
 parametric equalizer 40
 part numbers 4
 passwords 26
 PEQ (parametric equalizer) 41
 performance specifications 107
 phantom power 39
 physical and environmental specifications 107
 ping command 103
 PIP 50, 78, 92
 layout 50, 78
 source 50, 78, 92
 PIP screen 78
 point light compensation 64
 power down 102
 power on/power off 15, 73-74, 89, 101
 power up 102
 powering microphones 39
 precautions 4, 9
 for operating the system 9
 presets 62-63, 73-74, 76, 86
 clearing 74
 moving to 76, 86
 renaming 63

- setting 62, 74, 86
- Pro A/V status light color scheme 67
- product capabilities 2-3, 107
- puffy logo badge 6-8

Q

- quick reference 23-24, 30, 40, 64-65, 73-74
 - audio adjustments 40
 - new device system administration 23
 - remote control 73
 - system behaviors 30
 - Vaddio IR Remote Commander 74
 - web interface 24

R

- ready state 89, 101-102
- rebooting 72, 104
- recalibration, pan and tilt 103, 111
- red gain 63, 65, 87-88
- remote control 61, 68, 73-74
- requirements 2, 9-13
 - EasyIP system 2
 - installation 9-13
- reset 103, 111, See also rebooting; restoring
 - default settings
 - pan and tilt motors 103, 111
- restoring a configuration 70
- restoring default settings 104, 113
- Reverberant Room (audio setting) 40
- RJ-45 connectors 10
- room information 29
- Room Labels page (web) 29
- routing audio 46

S

- saving a configuration 70
- Security page (web) 26-27
- self-signed certificate 20
- settings, default, restoring 104, 113
- shelf-mounted cameras 14
- shelf, camera mount 13
- site requirements 9
- software update 71
- solving problems 109
- source 46
 - audio 46
- speaker 43
- speakers 44-45, 76, 94
 - adjusting for differing speech volumes 44

- adjusting volume 76
- equalizer 44
- muting 76, 94
 - synchronizing audio with video 45
- specifications 107
- Speech Enhancement (audio setting) 40
- speed 65-66, 73-74, 82-85
 - focus 85
 - Global Preset Non-Tri-Sync, setting 66
 - manual, setting 65
 - pan 65-66, 82
 - tilt 65-66, 83
 - zoom 65-66, 73-74, 84
- SSL certificate 27
- standby (low-power) state 89-90, 101
- standby state 59, 75, 102
 - behavior of connected devices 59
- status light 6-8, 67, 90, 111
 - behavior 6-7, 67, 90
 - color scheme 67
 - enabling/disabling 67
 - meanings of colors 111
- storage environment 115
- storing a configuration 70
- stream viewer 33
- streaming 33, 99
 - configuring 33
 - settings 33, 99
 - USB 33
- Streaming page (web) 33
- supported web browsers 16
- switch settings 13
- synchronizing audio with video 45
- syntax help, Telnet commands 106
- System page (web) 34, 59
- system time 28

T

- tablet 18
- technical specifications 107
- technical support 114
- Telnet 27
 - enabling 27
- Telnet commands 80-93, 98-99, 101, 103-106
 - syntax help 80, 106
 - typographical conventions 80
- Telnet session 80, 106
 - ending 106
 - history 106

temperature, operating and storage 115
 testing 55, 58
 macros 55
 triggers 58
 third-party control 80
 tilt 65-66, 73-74, 77, 83
 speed 65-66
 time zone 28
 trigger command, failure to execute 58
 trigger devices 53
 triggers 53, 57-58, 100
 defining 57
 deleting 57
 testing 58
 troubleshooting 103, 109

U

UC conferencing status light color scheme 67
 update 71
 uploading graphics files 50
 USB stream format 34
 USB streaming 33
 configuring 33
 User Interface page (web) 59
 user password 26
 changing 26

V

Vaddio Deployment Tool 17, 19
 accessing discovered devices 19
 check for the latest version 19
 features 17
 initial device set-up 19
 Vaddio Device Controller 17-18
 features 17
 Vaddio IR Remote Commander 73-74
 version, firmware 105
 video 49, 78, 92-93
 input source selection 92
 input type 93
 inputs 49
 PIP, configuring 78
 Video Inputs page (web) 49
 video mute 49, 75, 91
 Video Outputs page (web) 50
 Video Switching page (web) 48-49
 visual packing list 4
 visual parts identification 6-8

volume 76
 controls 76
 volume controls 38, 95

W

wall mount 13
 installing 13
 warranty 9
 web browsers supported 16
 web interface 16, 18-19, 21-22, 26-29, 33-34,
 37-40, 43-46, 48-50, 53-55, 57-59, 75,
 77, 114
 accessing 18-19, 21-22, 75
 Audio page 37-40, 43-46
 Control Devices page 53-55, 57-58
 Controls page 77
 Diagnostics page 114
 Graphics Library 50
 Help page 114
 Networking page 28
 Room Labels page 29
 Security page 26-27
 Streaming page 33
 System page 34
 User Interface page 59
 Video Inputs 49
 Video Outputs page 50
 Video Switching page 48-49
 wide dynamic range setting 64

Z

zoom 65-66, 73-74, 77, 84
 speed 65-66, 73-74, 84

Vaddio is a brand of Legrand AV Inc. · www.legrandav.com · Phone 800.572.2011 / +1.763.971.4400 · Fax +1.763.971.4464 · Email av.vaddio.support@legrand.com

Visit us at support.vaddio.com for firmware updates, specifications, drawings, manuals, technical support information, and more.

©2020 Legrand AV Inc.

Vaddio is a registered trademark of Legrand AV Inc. All other brand names or marks are used for identification purposes and are trademarks of their respective owners. All patents are protected under existing designations. Other patents pending.

A brand of  legrand®

Commercial AV Brands Chief | Da-Lite | Middle Atlantic | Projecta | Vaddio

vaddio®