

ZyPerUHD60

4K IP Video Distribution System

User Manual

Updated July, 2024

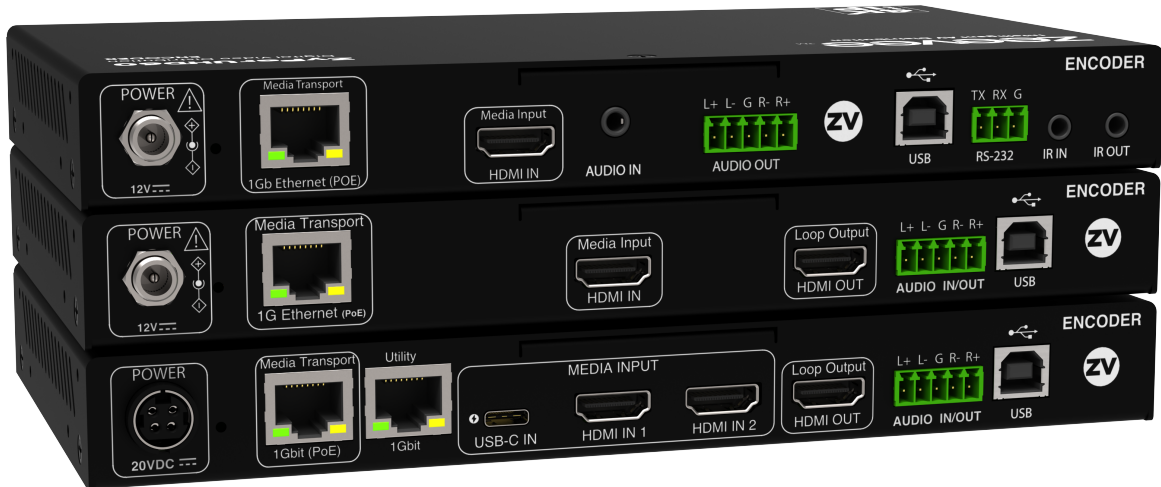

Important Note: Please see Appendix 3 regarding the use of PoE Switches and Shielded Ethernet cable.

Document symbol conventions:



Indicates an important piece of information affecting the operation of the unit. Retain this information.



Indicates a point of caution. Failure to heed this information may cause a hazard of some form to the operator or others in the field of operation.



Indicates a point regarding the electrical safety of the box. Failure to abide by the information presented may result in an electrical shock hazard to the operator or others in the field of operation.



Indicates a point affecting the RF performance of the box. Failure to heed or abide by the information presented may result in emissions or susceptibility that can affect the unit or nearby equipment. Performance conforming to the regulatory limit may be compromised or affected.

About ZeeVee:

ZeeVee is the leading manufacturer of high-quality encoder/modulator/decoder products for video distribution over any type of transmission media; be it RF coax, fiber, or copper ethernet.

Established in 2007, ZeeVee has been manufacturing industry-leading products while operating the company responsibly in compliance with the strictest levels of regulatory and environmental requirements. The standards by which we govern our corporate conduct are far higher than that required by law.

Our mission is to completely fulfill the toughest customer application requirements with the highest quality products we can produce. After the sale, we strive to support the customer with award-winning support and service. Our goal is that no customer shall ever be dissatisfied. It is both our mission and our passion.

ZeeVee, Incorporated
295 Foster Street, Suite 200
Littleton, Massachusetts
01460, USA

www.zeevee.com
support@zeevee.com
Phone: 1-877-493-3833

CONTENTS

System Description.....	1
ZyPerUHD60 Features	2
ZyPerUHD60 Part Numbers.....	3
Package Contents	6
System Elements	7
Encoder Function	7
Decoder Function	8
ZyPer Management Platform.....	9
ZyPer Management Platform Hardware.....	10
Detailed Interface Descriptions	11
Triple Input Dual LAN Encoder (Rev 2E, 2EA and 2EMP).....	11
Enclosure	11
Ports (Encoder Back).....	11
Ports (Encoder Front).....	12
USB-C Cable Requirements	13
Analog Audio.....	13
Single Input Single LAN Encoder (Rev 0E and 0EA)	14
Enclosure	14
Ports (Encoder Back).....	14
Ports (Encoder Front)	15
Analog Audio.....	15
Single Input Single LAN Encoder (Rev 1E and 1EA)	16
Enclosure	16
Ports (Encoder Back).....	16
Ports (Encoder Front).....	17
Analog Audio.....	17

Wallplate Encoder (Rev 1WE).....	18
Enclosure	18
Ports (Wallplate Encoder Front).....	19
USB-C Cable Requirements	20
Ports (Wallplate Encoder Back)	20
Dual LAN Decoder (Rev 2D and 2DA)	22
Enclosure	22
Ports (Decoder Back).....	22
Ports (Decoder Front)	23
Single LAN Decoder (Rev 1D and 1DA).....	24
Enclosure.....	24
Ports (Decoder Back)	24
Ports (Decoder Front)	25
Decoder “No Source Found” Background	26
Web Browser Interface	28
System Information Tab	28
Utilities Tab.....	29
Password Tab	30
Statistics Tab.....	30
Video Wall Tab.....	31
Network Tab	32
Function Tab.....	33
Routing.....	33
Video over IP.....	34
USB over IP	35
Serial over IP	36
Audio over IP	36
802.1X Tab.....	37

AES67 Tab	38
Preview Stream.....	39
HTTP Commands.....	40
Introduction	40
Basic Format	40
General Commands	40
Decoder Commands	42
Encoder Commands	42
Encoder Commands (UHD60-2E, 2EA and UHD60-2EMP).....	43
Dante AV-A.....	44
Dante Operation	46
Dante Related Console Commands.....	48
Decoder Dante Commands.....	48
Encoder Dante Commands	49
Dual Ethernet Port Dante Commands.....	51
Dual Port Dante Commands	52
AES67	54
Configuring Encoders for AES67.....	54
Configuring Decoders for AES67	58
Mounting Brackets	63
Power Save Mode	64
Switch Requirements	65
Configuring the ZyPerUHD60-2EMP	66
Setting up ZyPerUHD60	67
USB Details	68
Device Technical Specifications	69
Encoder and Decoder HDMI Video Specifications.....	69

Physical and Environmental	70
General Safety and Care Instructions	71
Safety	71
Cleaning	73
Encoder, Decoder and ZyPerMP Unit Cleaning Procedures	73
ZyPerMP Specific Cleaning Procedure.....	74
Important Siting and Application Considerations	75
ZyPerUHD60 Equipment Type and Uses	75
Installation Environment	76
Mounting Options	76
Ventilation	76
Water and moisture	77
AC Mains Connection	78
AC Power Cord.....	79
Responsibility and Stewardship	80
Reduction of Hazardous Substances (RoHS).....	80
Waste Electrical and Electronic Equipment	80
FCC Compliance Statement	82
EMC Information	83
Electromagnetic Emissions.....	83
Appendix 1.....	84
Known Good USB-C Cables	84
Appendix 2	85
USB-C Charging.....	85
USB-C Cable Requirements	85
Appendix 3	86
PoE Power and PoE Switches	86

Why Shielded Ethernet Cable Is Required	87
Appendix 4	89
Dual LAN Connection Options (Non-Dante UHD60 units).....	89
Appendix 5.....	91
Accessories	91
Disclaimers.....	92

System Description

The ZyPerUHD60 series of products from ZeeVee provide a means for transmitting and receiving audio-visual information across a standard IP network with outstanding quality at very low latencies.

A minimal system consists of:

- Video Source
- ZyPerUHD60 Encoder device
- CatX Cable
- ZyPerUHD60 Decoder device
- Video sink (display device)

A fully realized system consists of:

- (N) Video Sources
- (N) ZyPerUHD60 Encoder devices
- 1Gb Ethernet switching Infrastructure (> (N+M) ports of non-blocking capacity)
- (M) ZyPerUHD60 Decoder devices
- (M) Video sink (display devices)
- ZyPerMP control node

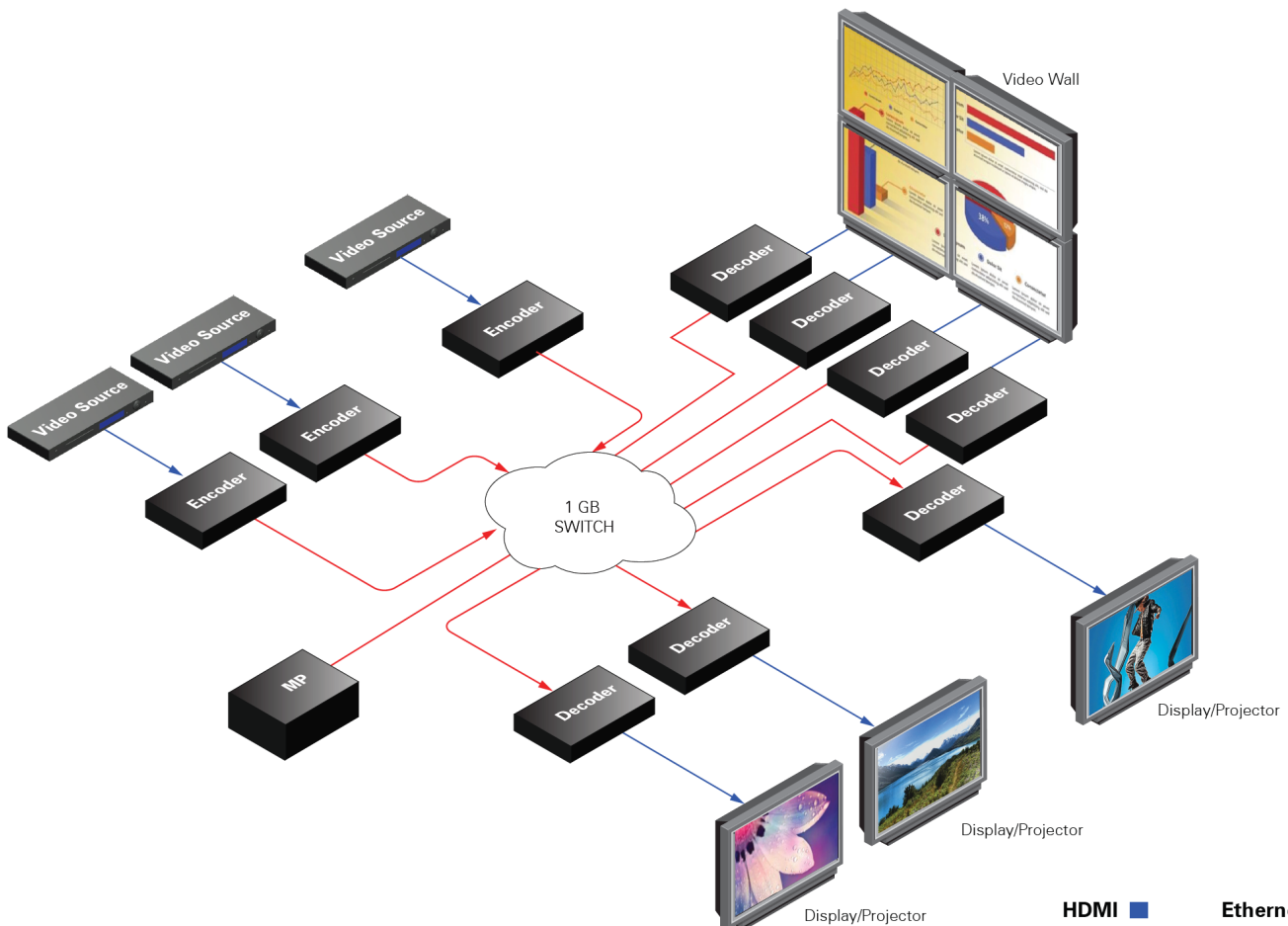

ZyPerUHD60 Features

- Distributes and switches 4K UHD AV signals via standard gigabit Ethernet networks
- Supports HDMI input and output resolutions up to 3840 x 2160@60Hz 4:4:4
- Supports USB-C Video input with resolutions up to 3840 x 2160@60Hz 4:4:4
- Supports streaming resolutions up to 3840 x 2160@60Hz 4:4:4
- Supports 7.1 channel audio
- Integrated Dante Embedded option with dedicated LAN port
- Supports independent analog audio input and output at 2 channels, 24 bits @48 kHz/channel
- HDCP 2.3 compliant
- Support Video walls up to 15 x 15 with bezel compensation
- Flexible routing policies, allowing audio, video together with IR, and USB signals to be routed separately or as a whole throughout the matrix system
- Capable of outputting IP streams that can easily be decoded and viewed on multiple decoders
- Allows AV, USB, IR, RS232 and power signals to be delivered up to 328 ft (100 m) over a single Cat 6 cable or above. (Cat 6a and above recommended)
- ~1 fps latency
- Supports independent balanced analog audio input and output at 2 channels, 24 bits@48 kHz/channel
- Supports bi-directional serial, allowing control of remote RS232 devices from both sides of encoders and IP controller
- Supports bi-directional IR, allowing control of remote source and display devices from both sides of encoders and decoders
- Encoder offers a USB-Host port directly connect to a PC and complies with USB 2.0 standard
- Decoder offers two USB type A ports to directly connect to a keyboard and a mouse and complies with USB 2.0 standard, providing +5 VDC at up to 500 mA to connected USB peripherals.
- Offers point-to-point, point-to-multipoint, multipoint-to-point, multipoint-to-multipoint applications
- Supports PoE to be remotely powered by compatible power source equipment such as a PoE-enabled Ethernet switch, eliminating the need for a nearby power outlet

ZyPerUHD60 Part Numbers

Part Number	Description
ZUHD60-0E	ZyPerUHD60, HDMI 2.0 input Encoder with phoenix connector for analog audio out, 3.5mm jack for audio input, with IP streaming via Gbit/copper. Supports HDMI 2.0a capable of up to 4KP60 4:4:4 with embedded audio and HDCP 2.3 encryption, USB, IR, RS-232 (via phoenix) and POE. Includes IR pigtail and wall mount brackets. Requires ZyPerUHD60 Decoder. Cables not included.
ZUHD60-0EA	ZyPerUHD60, HDMI 2.0 input Dante Enabled Encoder with phoenix connector for analog audio out, 3.5mm jack for audio input, with IP streaming via Gbit/copper. Supports HDMI 2.0a capable of up to 4KP60 4:4:4 with embedded audio and HDCP 2.3 encryption, USB, IR, RS-232 (via phoenix) and POE. Includes IR pigtail and wall mount brackets. Requires ZyPerUHD60 Decoder. Cables not included.
ZUHD60-1E	ZyPerUHD60, HDMI 2.0 input Encoder with phoenix connector for analog audio in/out, with IP streaming via Gbit/copper. Supports HDMI 2.0a capable of up to 4KP60 4:4:4 with embedded audio and HDCP 2.3 encryption, USB, IR, RS-232 (via phoenix), HDMI passthrough , and POE. Includes IR pigtail and wall mount brackets. Requires ZyPerUHD60 Decoder. Cables not included.
ZUHD60-1D	ZyPerUHD60, HDMI 2.0 output Decoder with phoenix connectors for analog audio, accepts IP streaming via Gbit/copper. Supports USB, IR, RS-232 (via phoenix), POE. Includes IR pigtail and wall mount brackets. Requires ZyPerUHD60 Encoder. Cables not included.
ZUHD60-1EA	ZyPerUHD60, HDMI 2.0 input Dante Enabled Encoder with phoenix connector for analog audio in/out, with IP streaming via Gbit/copper. Supports HDMI 2.0a capable of up to 4KP60 4:4:4 with embedded audio and HDCP 2.3 encryption, USB, IR, RS-232 (via phoenix), HDMI passthrough , and POE. Includes IR pigtail and wall mount brackets. Requires ZyPerUHD60 Decoder. Cables not included.
ZUHD60-1DA	ZyPerUHD60, HDMI 2.0 output Dante Enabled Decoder with phoenix connectors for analog audio, accepts IP streaming via Gbit/copper. Supports USB, IR, RS-232 (via phoenix), POE. Includes IR pigtail and wall mount brackets. Requires ZyPerUHD60 Encoder. Cables not included.
ZUHD60-1WE	ZyPerUHD60, HDMI 2.0 input Wall Plate Encoder with IP streaming via Gbit/copper. Supports HDMI 2.0a and USB-C video inputs capable of up to 4KP60 4:4:4 with embedded audio and HDCP 2.3 encryption, USB, and POE. Requires ZyPerUHD60 Decoder. Cables not included.

Part Number	Description
ZUHD60-2E	ZyPerUHD60, Switching triple input Encoder (Dual HDMI and USB-C) with phoenix connector for analog audio in/out, with IP streaming via Gbit/copper. Supports HDMI 2.0a capable of up to 4KP60 4:4:4 with embedded audio and HDCP 2.3 encryption, USB, IR, RS-232 (via phoenix), HDMI passthrough, and Dual 1G LAN ports (1 supporting POE). Includes IR pigtail and wall mount brackets. Requires ZyPerUHD60 Decoder. Cables not included. 20V supply available separately to supply charging over USB-C port.
ZUHD60-2D	ZyPerUHD60, HDMI 2.0 output Decoder with phoenix connectors for analog audio, accepts IP streaming via Gbit/copper. Supports USB, IR, RS-232 (via phoenix), Dual LAN ports (1 supports POE). Includes IR pigtail and wall mount brackets. Requires ZyPerUHD60 Encoder. Cables not included.
ZUHD60-2EMP	ZyPerUHD60, Switching triple input Encoder (Dual HDMI and USB-C) with phoenix connector for analog audio in/out, with IP streaming via Gbit/copper. Supports HDMI 2.0a capable of up to 4KP60 4:4:4 with embedded audio and HDCP 2.3 encryption, USB, IR, RS-232 (via phoenix), HDMI passthrough, and Dual 1G LAN ports (1 supporting POE). Includes IR pigtail and wall mount brackets. Requires ZyPerUHD60 Decoder. Cables not included. 20V supply available separately to supply charging over USB-C port. Includes integrated ZyPer Management Platform running on a dedicated processor capable of supporting up to 20 ZyPer endpoints.
ZUHD60-2EA	ZyPerUHD60, Dante Enabled Switching triple input Encoder (Dual HDMI and USB-C) with phoenix connector for analog audio in/out, with IP streaming via Gbit/copper. Supports HDMI 2.0a capable of up to 4KP60 4:4:4 with embedded audio and HDCP 2.3 encryption, USB, IR, RS-232 (via phoenix), HDMI passthrough, and Dual 1G LAN ports (1 supporting POE). Includes IR pigtail and wall mount brackets. Requires ZyPerUHD60 Decoder. Cables not included. 20V supply available separately to supply charging over USB-C port.
ZUHD60-2DA	ZyPerUHD60, HDMI 2.0 output Dante Enabled Decoder with phoenix connectors for analog audio, accepts IP streaming via Gbit/copper. Supports USB, IR, RS-232 (via phoenix), Dual LAN ports (1 supports POE). Includes IR pigtail and wall mount brackets. Requires ZyPerUHD60 Encoder. Cables not included.
ZUHD60RACK	6RU Rack mount chassis. Holds up to 10 ZyPerUHD60 encoders/decoders. Includes 4 blank panels.
ZUHD60BP	Spare blank panel for ZUHD60RACK
12V2APS	12 Volt, 2A Power Supply for UHD60 units. (Not compatible with 2E, 2EA, 2EMP and 1WE encoders) Not required if using PoE for power.

Part Number	Description
20V6APS	20 Volt, 6A Power Supply for UHD60 Encoder units. (Only compatible with 2E, 2EA and 2EMP units)
U60WPPS	ZyPerUHD60 20V 6A power supply with 2-pin phoenix connector for UHD60 Wallplate, with US power cable. (Only compatible with Wallplate Encoder)
U60WP-Black	Black decora face plate and black panels for ZUHD60-1WE. Note this is a spare set of black plastic panels. Both black and white sets ship in the box with UHD60 Wallplate Encoder. Spare set does not have ZeeVee silkscreen.

Package Contents

Triple Input Dual LAN Encoder

- 1 x ZUHD60-2E or ZUHD60-2EA
- 1 x Phoenix Port (Male, 3.5mm, 3 pins)
- 1 x Phoenix Port (Male, 3.5mm, 5 pins)
- 1 x 940nm IR Emitter (3.9 ft - 1.2m) 150mA Peak.
- 1 x IR Wideband Receiver (3.9 ft - 1.2m, 30kHz ~ 50 kHz)
- 2 x Mounting Ear and 4x Screws

Single Input Single LAN Encoder

- 1 x ZUHD60-0E, ZUHD60-1E, ZUHD60-0EA or ZUHD60-1EA
- 1 x Phoenix Port (Male, 3.5mm, 3 pins)
- 1 x Phoenix Port (Male, 3.5mm, 5 pins)
- 1 x 940nm IR Emitter (3.9 ft - 1.2m) 150mA Peak.
- 1 x IR Wideband Receiver (3.9 ft - 1.2m, 30kHz ~ 50 kHz)
- 2 x Mounting Ear and 4x Screws

Dual LAN Decoder

- 1 x ZUHD60-2D or ZUHD60-2DA
- 1 x Phoenix Port (Male, 3.5mm, 3 pins)
- 1 x Phoenix Port (Male, 3.5mm, 5 pins)
- 1 x 940nm IR Emitter (3.9 ft - 1.2m) 150mA Peak.
- 1 x IR Wideband Receiver (3.9 ft - 1.2m, 30kHz ~ 50 kHz)
- 2 x Mounting Ear and 4x Screws

Single LAN Decoder

- 1 x ZUHD60-1D or ZUHD60-1DA
- 1 x Phoenix Port (Male, 3.5mm, 3 pins)
- 1 x Phoenix Port (Male, 3.5mm, 5 pins)
- 1 x 940nm IR Emitter (3.9 ft - 1.2m) 150mA Peak.
- 1 x IR Wideband Receiver (3.9 ft - 1.2m, 30kHz ~ 50 kHz)
- 2 x Mounting Ear and 4x Screws

Wallplate Encoder

- 1 x ZUHD60-1WE
- 2 x Faceplate (1 White and 1 Black)
- 2 x Decora front cover options (White and Black)
- 1 x Phoenix Port (Male, 3.5mm, 3 pins)
- 1 x Phoenix Port (Male, 3.5mm, 5 pins)

System Elements

Encoder Function

The function of the ZyPerUHD60 Encoder Device (Encoder) is to accept audio and video data over a variety of interface types, and translate that data to a format suitable for transmission over a standard 1Gb Ethernet network.

Video data is segmented, compressed using JPEG2000, prepared for transmission, and sent by the Encoder unit. No unit other than those so designated by the control entity shall be able to receive the video stream sent by an Encoder.

The format of the IP data is fully in compliance with industry-standard IEEE 802.3 Ethernet networking practices. Any switch or device capable of passing 1Gb Ethernet traffic can be employed to carry ZyPerUHD60 A/V traffic.

Other ports on the Encoder devices are for the carriage of USB, IR, RS232 and audio data.

Interfaces on Triple Input Dual LAN Encoders: Rev 2E, Rev 2EA and Rev 2EMP

- Power Input (20VDC)
- RS232 Input/Output (Phoenix connector with supplied adapter)
- Analog Audio Input/Output (Phoenix connectors with supplied adapters)
- Infrared Input/Output
- 2x HDMI Inputs and 1x USB-C Video Input
- HDMI Output (loop-out)
- USB Host Type-B interface
- 1Gb Ethernet port (RJ45 with PoE)
- 1Gb Ethernet port (RJ45) Dante or Utility

Interfaces on Single Input Single LAN Encoders: Rev 0E and Rev 0EA

- Power Input (12VDC)
- RS232 Input/Output (Phoenix connector with supplied adapter)
- Analog Audio Input (3.5mm jack)
- Analog Audio Output (Phoenix connector with supplied adapter)
- Infrared Input/Output
- HDMI Input
- USB Host Type-B interface
- 1Gb Ethernet port (RJ45 with PoE)

Interfaces on Single Input Single LAN Encoders: Rev 1E and Rev 1EA

- Power Input (12VDC)
- RS232 Input/Output (Phoenix connector with supplied adapter)
- Analog Audio Input/Output (Phoenix connects with supplied adapter)
- Infrared Input/Output
- HDMI Input

- HDMI Output (loop-out)
- USB Host Type-B interface
- 1Gb Ethernet port (RJ45 with PoE)

Interfaces on Wallplate Encoders: Rev 1WE

- Power Input (12VDC)
- RS232 Input/Output (3.5mm jack)
- HDMI Input
- USB-C Video Input
- USB Host Type-C interface
- 1Gb Ethernet port (RJ45 with PoE)

Decoder Function

The function of the ZyPerUHD60 Decoder device (Decoder) is to accept 1Gb Ethernet traffic that represents the information to be decoded and displayed. When the appropriate IP stream is received the Decoder unit will decompress it, reformat the video and audio information for display and play it out its HDMI video output. Audio is also played out the appropriate port as included.

Other ports on the Decoder devices are for the carriage of USB, IR, RS232 and audio data.

Interfaces on Dual LAN Standard Decoders: Rev 2D and Rev 2DA

- Infrared Input/Output
- HDMI Output
- 1Gb Ethernet (RJ45 with PoE)
- 1Gb Ethernet (RJ45) Dante or Utility
- 2 USB Type-A Interfaces
- Analog Audio Output (Phoenix connector with supplied adapter)
- RS232 Input/Output (Phoenix connector with supplied adapter)
- Power Input (12VDC)

Interfaces on Single LAN Decoders: Rev 1D and Rev 1DA

- Infrared Input/Output
- HDMI Output
- 1Gb Ethernet (RJ45 with PoE)
- 2 USB Type-A Interfaces
- Analog Audio Output (Phoenix connector with supplied adapter)
- RS232 Input/Output (Phoenix connector with supplied adapter)
- Power Input (12VDC)

ZyPer Management Platform



Installations may require a ZyPer Management Platform (ZMP). This device controls the operation and manages the connectivity between endpoints. The management platform is a hardened controller node that must reside on the same logical network as the ZyPerUHD60 Encoders and Decoders. It runs a ZeeVee application as its sole function. The application presents an API to potential third party management platforms as well as hosting its own management application.

The purpose of the Management Platform is to interface user operational requests into the specific device-level control needed to effect connectivity changes, screen management, interface management, and distribute software and control data to all the endpoints of the overall system. The ZMP is the entity that insures all the endpoints, are accounted for, operating properly, and performing the correct operation at the correct time.

Further, the ZMP is the element that guarantees security, manages access to the overall system and prevents rogue listeners or observers from snooping or spoofing unwanted content.

Two ZMP devices may be deployed in a redundant configuration to provide for fault tolerant control of the greater ZyPerUHD60 overall system.

Operation of the ZMP, the management application, and the ZyPer-API are beyond the scope of this manual and are documented separately in far greater detail in the *ZyPer Management Platform User Manual*. Documentation can be downloaded from the ZeeVee website.

<https://www.zeevee.com/documentation-all-products>

ZyPer Management Platform Hardware

The ZyPer Management Platform (ZMP) is available from ZeeVee in three different hardware options. NUC, Rack Mount Server and ZyPerUHD60-2EMP. All versions have two network interfaces. It is important that the port labeled “Video Network” is connected to the LAN containing the ZyPerUHD60 encoder/decoder endpoints. The port labeled “Management Network” is available to separate the Video AV Network from a corporate or Control Network.

ZyPerUHD60-2EMP - Both Ethernet ports are for the same LAN. This product does not currently support the Management Network Port. It only supports the Video Network Port.

Rack Mount ProServer ZMP

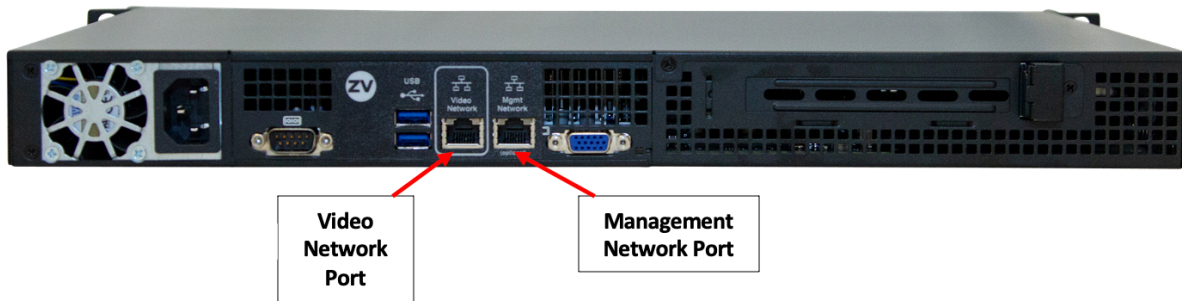

NUC ZMP

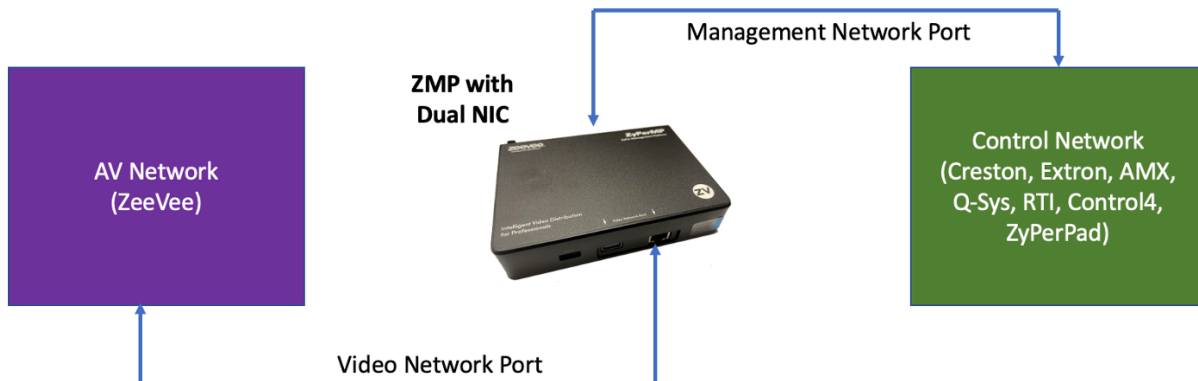
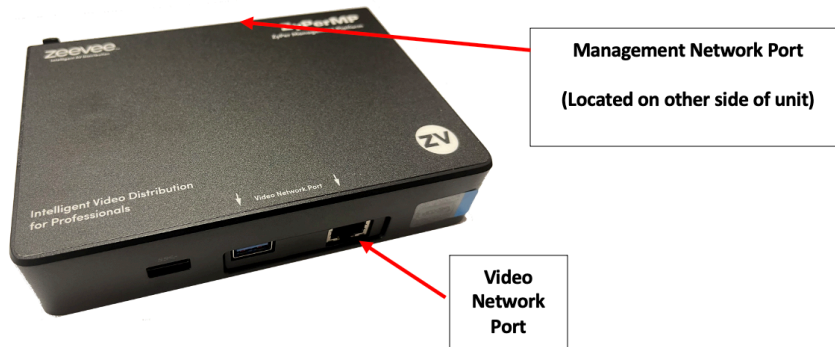

Detailed Interface Descriptions

Triple Input Dual LAN Encoder (Rev 2E, 2EA and 2EMP)

The function of the encoder is to accept raw video images, encode, encrypt and format them for transmission.

Enclosure

There is one size of the ZyPerUHD60 Encoder unit enclosure.

Input Function	Box Size
Dual HDMI and USB-C Video Input	215mm x 120m x 25mm

Ports (Encoder Back)

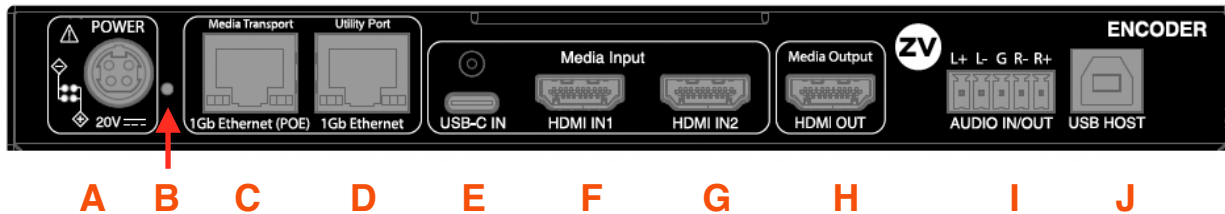

Port Name	Index	Definition
Power	A	20VDC from supply. (Only required to provide power out USB-C port)
Hardware Reset	B	Recessed hardware reset pin. Disconnect ZyPerUHD60 from network and delete unit from within ZyPer Management Platform. Then, fully power unit, press and hold pin for 10-15 seconds and the unit will reset to defaults. Reconnect to network and reconfigure in ZMP.
Ethernet (PoE)	C	1Gb Ethernet over Cat6 (or better) cabling. RJ45 with PoE. Important Note: If using PoE with ZyPerUHD60 units; the ZyPerUHD60 must have a path to the ground. This grounding can be accomplished by using a shielded network cable. See Appendix 3.
Ethernet	D	1Gb Ethernet over Cat6 (or better) cabling. RJ45. Dedicated port for Dante or Utility Port. Should not be used to “daisy chain” ZUHD60 units together.
USB-C	E	Full featured USB-C DisplayPort port (DP-Alt Mode) supporting both Video and USB Host functionality. Can support device charging only if 20V source connected to unit. Cannot charge if UHD60 using PoE power only.

Port Name	Index	Definition
HDMI Input #1	F	HDMI 2.0a input port capable of up to 4KP60 4:4:4 with embedded audio and HDCP 2.3 encryption.
HDMI Input #2	G	HDMI 2.0a input port capable of up to 4KP60 4:4:4 with embedded audio and HDCP 2.3 encryption.
HDMI Output	H	HDMI loop-out of video/audio received on active input port. (Either HDMI or USB-C)
Audio In/ Out	I	Audio Input/Output connector. Input/Output of balanced stereo audio on Phoenix connector.
USB Host	J	USB 2.0 Host port. Configuration and routing of USB handled by the ZyPer Management Platform configuration. Use this port for USB if HDMI is used for video input.

Ports (Encoder Front)



Port Name	Index	Definition
Power LED	A	LED illuminated when unit is powered. (Green)
Status LED	B	LED Illuminated when active video is being processed. Flashes when no video is connected (Green)
USB-C LED	C	LED illuminated when USB-C video input is active
HDMI In 1 LED	D	LED illuminated when HDMI Input #1 is active
HDMI In 2 LED	E	LED illuminated when HDMI Input #2 is active
RS232	F	RS232 Control Port for sending and receiving side-band serial traffic to/from decoders as directed by ZyPer Management Platform.
IR Input	G	Infrared Commands to be passed TO Decoders as configured by ZMP.
IR Output	H	Infrared Commands information passed FROM Decoders to Encoders as configured by ZMP. Max current 330mA.

Important USB-C information:

To ensure proper operation when using the USB-C input for video and/or USB-Host function and/or USB charging the USB-C cable must meet certain requirements.

USB-C Cable Requirements

1. Cable should be as short as possible
2. Must have USB-IF certification
3. Must be USB 3.2 Gen2 (2x1 or 2x2)
4. Current rating of 5A
5. Must support USB power delivery of 100W, 20V/5A
6. Data specs must be 10Gbps per lane (4K@60Hz) or above. (20Gbps cable)
7. USB Data specs must be 5Gbps (USB 3.0)
8. Must have built in E-Mark IC

Please see Appendix 1 near the end of this document for a list of known good USB-C cables.

ZeeVee is not responsible for damage to any equipment caused by poor or incorrect USB-C cables.

Analog Audio

The ZyPerUHD60 encoder supports a balanced analog audio input/output on a 5-pin phoenix connector. (Note than connector can be input or output but not both at the same time)

Analog output would be 2-channel down-mixed audio from HDMI input. (PCM audio only)

Analog audio input can be routed independently from any video input that is present on the HDMI port. Also note that it is not a requirement for HDMI video input to be present. The ZyPerUHD60 encoder analog audio input can be routed to the analog audio output of any ZyPerUHD60 decoder.

Single Input Single LAN Encoder (Rev 0E and 0EA)

The function of the encoder is to accept raw video images, encode, encrypt and format them for transmission.

Enclosure

There is one size of the ZyPerUHD60 Encoder unit enclosure.

Input Function	Box Size
HDMI Input	215mm x 120m x 25mm

Ports (Encoder Back)



Port Name	Index	Definition
Power	A	12VDC from supply. Center Post is + Ring is -
Hardware Reset	B	Recessed hardware reset pin. Disconnect ZyPerUHD60 from network and delete unit from within ZyPer Management Platform. Then, fully power unit, press and hold pin for 10-15 seconds and the unit will reset to defaults. Reconnect to network and reconfigure in ZMP.
Ethernet (PoE)	C	1Gb Ethernet over Cat6 (or better) cabling. RJ45 with PoE. Important Note: If using PoE with ZyPerUHD60 units; the ZyPerUHD60 must have a path to the ground. This grounding can be accomplished by using a shielded network cable (F/UTP)
HDMI Input	D	HDMI 2.0a input port capable of up to 4KP60 4:4:4 with embedded audio and HDCP 2.3 encryption.
Audio In	E	Audio Input connector. Input/Output of unbalanced stereo audio on 3.5mm connector.
Audio Out	F	Audio Output connector. Input/Output of balanced stereo audio on Phoenix connector.

Port Name	Index	Definition
USB Type B (Host)	G	USB 2.0 Host port. Configuration and routing of USB handled by the ZyPer Management Platform configuration.
RS232	H	RS232 Control Port for sending and receiving side-band serial traffic to/from decoders as directed by ZyPer Management Platform.
IR Input	I	Infrared Commands to be passed TO Decoders as configured by ZMP.
IR Output	J	Infrared Commands information passed FROM Decoders to Encoders as configured by ZMP. Max current 330mA.

Ports (Encoder Front)

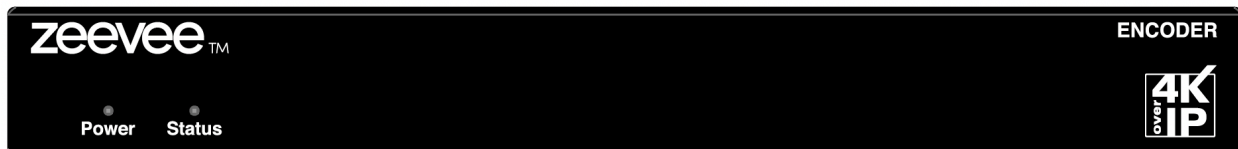

A B

Port Name	Index	Definition
Power LED	A	LED illuminated when unit is powered. (Green)
Status LED	B	LED Illuminated when active video is being processed. Flashes when no video is connected. (Green)

Analog Audio

The ZyPerUHD60 encoder supports a balanced analog audio input/output on a 5-pin phoenix connector. (Note than connector can be input or output but not both at the same time)

Analog output would be 2-channel down-mixed audio from HDMI input. (PCM audio only)

Analog audio input can be routed independently from any video input that is present on the HDMI port. Also note that it is not a requirement for HDMI video input to be present. The ZyPerUHD60 encoder analog audio input can be routed to the analog audio output of any ZyPerUHD60 decoder.

Single Input Single LAN Encoder (Rev 1E and 1EA)

The function of the encoder is to accept raw video images, encode, encrypt and format them for transmission.

Enclosure

There is one size of the ZyPerUHD60 Encoder unit enclosure.

Input Function	Box Size
HDMI Input	215mm x 120m x 25mm

Ports (Encoder Back)

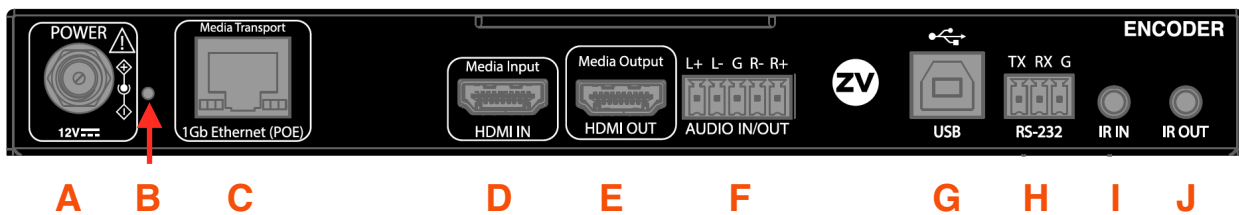

Port Name	Index	Definition
Power	A	12VDC from supply. Center Post is + Ring is -
Hardware Reset	B	Recessed hardware reset pin. Disconnect ZyPerUHD60 from network and delete unit from within ZyPer Management Platform. Then, fully power unit, press and hold pin for 10-15 seconds and the unit will reset to defaults. Reconnect to network and reconfigure in ZMP.
Ethernet (PoE)	C	1Gb Ethernet over Cat6 (or better) cabling. RJ45 with PoE. Important Note: If using PoE with ZyPerUHD60 units; the ZyPerUHD60 must have a path to the ground. This grounding can be accomplished by using a shielded network cable. See Appendix 3.
HDMI Input	D	HDMI 2.0a input port capable of up to 4KP60 4:4:4 with embedded audio and HDCP 2.3 encryption.
HDMI Output	E	HDMI loop-out of video/audio received on HDMI input port.
Audio In/Out	F	Audio connector. Input/Output of balanced stereo audio on Phoenix connector.

Port Name	Index	Definition
USB Type B (Host)	G	USB 2.0 Host port. Configuration and routing of USB handled by the ZyPer Management Platform configuration.
RS232	H	RS232 Control Port for sending and receiving side-band serial traffic to/from decoders as directed by ZyPer Management Platform.
IR Input	I	Infrared Commands to be passed TO Decoders as configured by ZMP.
IR Output	J	Infrared Commands information passed FROM Decoders to Encoders as configured by ZMP. Max current 330mA.

Ports (Encoder Front)

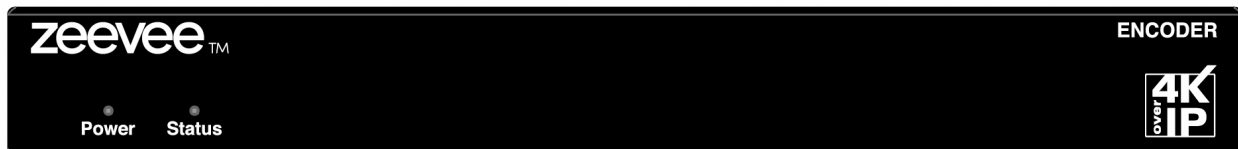

A B

Port Name	Index	Definition
Power LED	A	LED illuminated when unit is powered. (Green)
Status LED	B	LED Illuminated when active video is being processed. Flashes when no video is connected. (Green)

Analog Audio

The ZyPerUHD60 encoder supports a balanced analog audio input/output on a 5-pin phoenix connector. (Note than connector can be input or output but not both at the same time)

Analog output would be 2-channel down-mixed audio from HDMI input. (PCM audio only)

Analog audio input can be routed independently from any video input that is present on the HDMI port. Also note that it is not a requirement for HDMI video input to be present. The ZyPerUHD60 encoder analog audio input can be routed to the analog audio output of any ZyPerUHD60 decoder.

Wallplate Encoder (Rev 1WE)

The function of the encoder is to accept raw video images, encode, encrypt and format them for transmission.

Enclosure

There is one size of the ZyPerUHD60 Wallplate Encoder unit enclosure

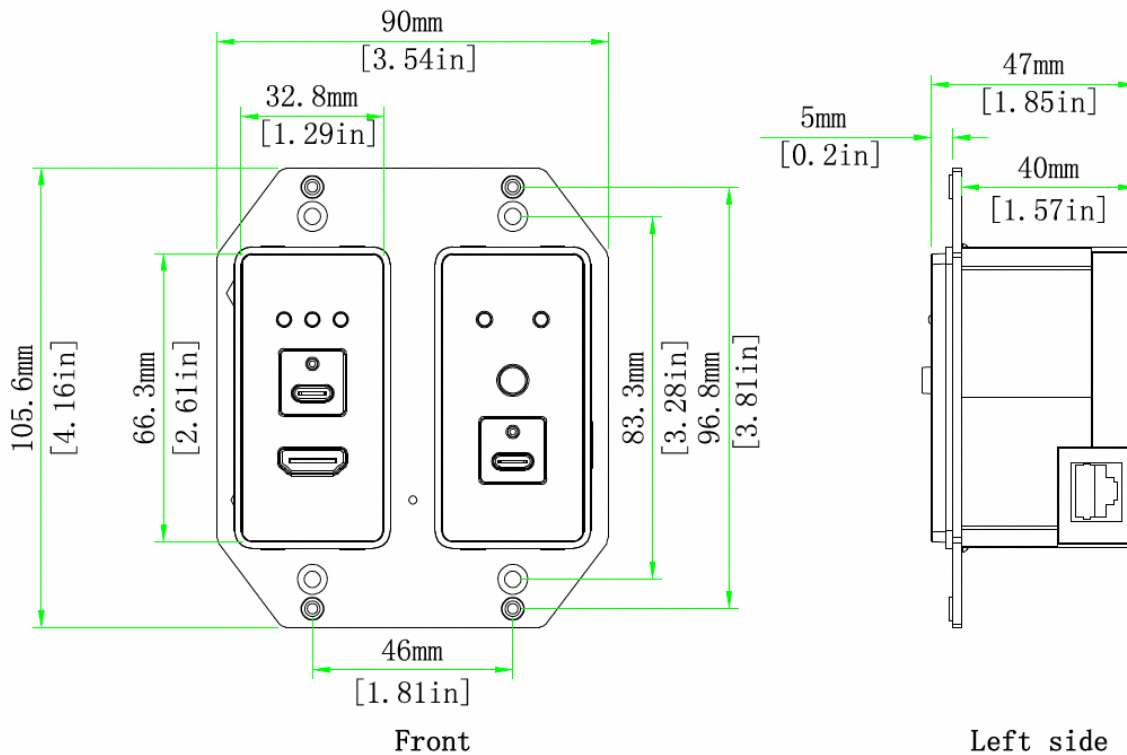

Input Function	Box Size
HDMI and USB-C Video Inputs	Standard 2-Gang box (90mm Wide x 105.6mm High x 47mm Deep)

Ports (Wallplate Encoder Front)

Cover plates removable. White and Black versions included in the box. White shown installed below:

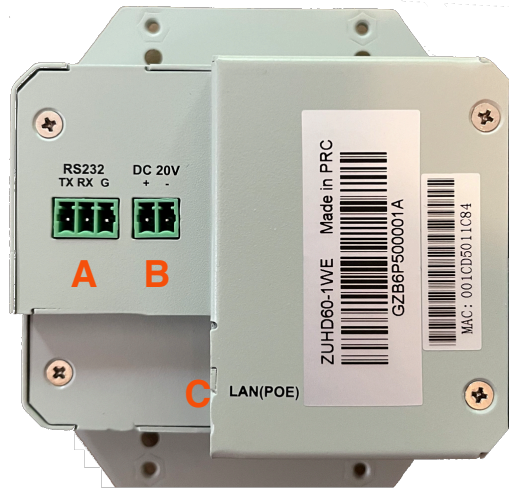
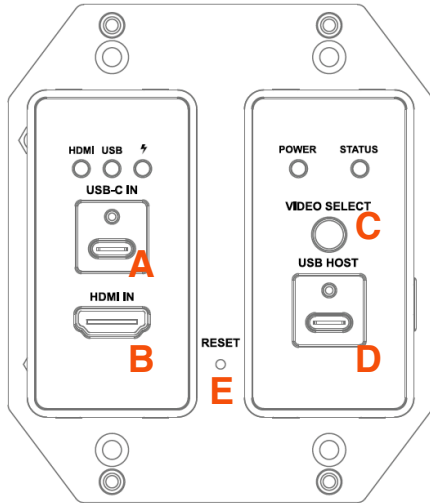

Port Name	Index	Description
USB-C IN	A	Full featured USB-C DisplayPort port (DP-Alt Mode) supporting both Video and USB Host functionality. Can support device charging only if 20V source connected to unit. Cannot charge if UHD60 using PoE power only.
HDMI	B	HDMI 2.0a input port capable of up to 4KP60 4:4:4 with embedded audio and HDCP 2.3 encryption.
Video Select	C	Button to select between USB-C and HDMI video inputs.

Port Name	Index	Description
USB-Host	D	USB 2.0 Host port in USB-C form factor. Configuration and routing of USB handled by the ZyPer Management Platform configuration. Use this port for USB if HDMI is used for video input.
Hardware Reset	E	Recessed hardware reset pin. To reset the device to factory defaults, unplug it from the network and power(if not using POE). Delete the unit from the ZyPer Management Platform. Reapply power and wait for the unit to fully boot. Once it is up, then push and hold the reset pin for 10-15 seconds. Then reconnect to the network and reconfigure it.

Important USB-C information:

To ensure proper operation when using the USB-C input for video and/or USB-Host function and/or USB charging the USB-C cable must meet certain requirements.

USB-C Cable Requirements

1. Cable should be as short as possible
2. Must have USB-IF certification
3. Must be USB 3.2 Gen2 (2x1 or 2x2)
4. Current rating of 5A
5. Must support USB power delivery of 100W, 20V/5A
6. Video Data specs must be 10Gbps per lane (4K@60Hz) or above. (20Gbps cable)
7. USB Data specs must be 5Gbps (USB 3.0)
8. Must have built in E-Mark IC

Please see Appendix 1 near the end of this document for a list of known good USB-C cables.

ZeeVee is not responsible for damage to any equipment caused by poor or incorrect USB-C cables.

Ports (Wallplate Encoder Back)

Port Name	Index	Description
RS232	A	RS232 Control Port for sending and receiving side-band serial traffic to/from decoders as directed by ZyPer Management Platform.
Power	B	DC 20V power. Only required if PoE not available or to provide up to 60W output power from USB-C Video Port. Power supply not included with unit.

Port Name	Index	Description
Ethernet (PoE)	C	1Gb Ethernet over Cat6 (or better) cabling. RJ45 with PoE. Important Note: If using PoE with ZyPerUHD60 units; the ZyPerUHD60 must have a path to the ground. This grounding can be accomplished by using a shielded network cable. See Appendix 3.

Dual LAN Decoder (Rev 2D and 2DA)

The function of the ZyPerUHD60 Decoder is to accept a 1Gb IP feed containing the video information to be displayed. It decodes and formats the video and audio information for display on the attached viewing device.

Enclosure

There is one size of the ZyPerUHD60 Decoder unit enclosure.

Input Function	Box Size
HDMI Output	215mm x 120mm x 25mm

Ports (Decoder Back)



Port Name	Index	Definition
Power	A	12VDC from supply. Center Post is + Ring is -
Hardware Reset	B	Recessed hardware reset pin. Disconnect ZyPerUHD60 from network and delete unit from within ZyPer Management Platform. Then, fully power unit, press and hold pin for 10-15 seconds and the unit will reset to defaults. Reconnect to network and reconfigure in ZMP.
Ethernet (PoE)	C	1Gb Ethernet over Cat6 (or better) cabling. RJ45 with PoE. Important Note: If using PoE with ZyPerUHD60 units; the ZyPerUHD60 must have a path to the ground. This grounding can be accomplished by using a shielded network cable or by making sure the ZyPerUHD60 itself or the connected HDMI display is grounded. (i.e. A 3-prong power connector on display) See Appendix 3.

Port Name	Index	Definition
Ethernet	D	1Gb Ethernet over Cat6 (or better) cabling. RJ45. Dedicated port for Dante or Utility. Should not be used to “daisy chain” ZUHD60 units together.
HDMI Out	F	HDMI 2.0a output port capable of up to 4KP60 4:4:4 with embedded audio and HDCP 2.3 encryption.
Audio Out	D	Audio Output connector. Output of balanced stereo audio on Phoenix connector.
RS232	E	RS232 Control Port for sending and receiving side-band serial traffic to/from decoders as directed by ZMP.
IR Input	G	Infrared Commands to be passed TO Encoders as configured by ZMP.
IR Output	H	Infrared Commands information passed FROM Encoders to Decoders as configured by ZMP. Max current 330mA.

Ports (Decoder Front)



A B

C

Port Name	Index	Definition
Power LED	A	LED illuminated when unit is powered. (Green)
Status LED	B	LED illuminated when active video is being processed. (Green)
USB	C	2 ports of USB 2.0 Type-A connectivity. Either port may be used and both operate simultaneously. Each port may provide up to 0.5A of power output (5V).

Single LAN Decoder (Rev 1D and 1DA)

The function of the ZyPerUHD60 Decoder is to accept a 1Gb IP feed containing the video information to be displayed. It decodes and formats the video and audio information for display on the attached viewing device.

Enclosure

There is one size of the ZyPerUHD60 Lite Decoder unit enclosure.

Input Function	Box Size
HDMI Output	215mm x 120mm x 25mm

Ports (Decoder Back)

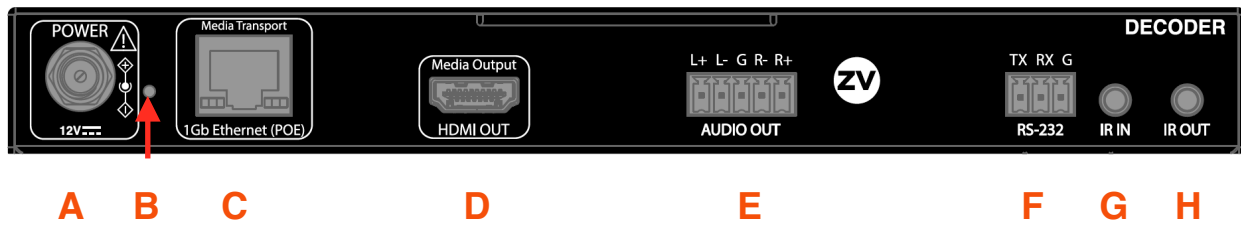

Port Name	Index	Definition
Power	A	12VDC from supply. Center Post is + Ring is -
Hardware Reset	B	Recessed hardware reset pin. Disconnect ZyPerUHD60 from network and delete unit from within ZyPer Management Platform. Then, fully power unit, press and hold pin for 10-15 seconds and the unit will reset to defaults. Reconnect to network and reconfigure in ZMP.
Ethernet (PoE)	C	1Gb Ethernet over Cat6 (or better) cabling. RJ45 with PoE. Important Note: If using PoE with ZyPerUHD60 units; the ZyPerUHD60 must have a path to the ground. This grounding can be accomplished by using a shielded network cable or by making sure the ZyPerUHD itself or the connected HDMI display is grounded. (i.e. A 3-prong power connector on display) See Appendix 3.

Port Name	Index	Definition
HDMI Out	D	HDMI 2.0a output port capable of up to 4KP60 4:4:4 with embedded audio and HDCP 2.3 encryption.
Audio Out	E	Audio Output connector. Output of balanced stereo audio on Phoenix connector.
RS232	F	RS232 Control Port for sending and receiving side-band serial traffic to/from decoders as directed by ZMP.
IR Input	G	Infrared Commands to be passed TO Encoders as configured by ZMP.
IR Output	H	Infrared Commands information passed FROM Encoders to Decoders as configured by ZMP. Max current 330mA.

Ports (Decoder Front)



Port Name	Index	Definition
Power LED	A	LED illuminated when unit is powered. (Green)
Status LED	B	LED Illuminated when active video is being processed. (Green)
USB	C	2 ports of USB 2.0 Type-A connectivity. Either port may be used and both operate simultaneously. Each port may provide up to 0.5A of power output.(5V)

Decoder “No Source Found” Background

The ZyPerUHD60 decoder will output a default screen when no active video source is routed from an encoder to the decoder. This default background can be changed to any custom background desired.

The default background looks something like this:

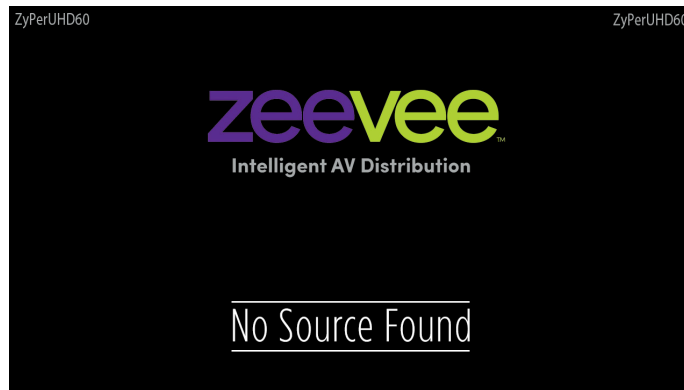

The default background can be changed from the ZyPer Management Platform GUI in the **Display Grid** page **Config** tab.

				Actions	Port Mode		
Icon	Name	Model	IdleImage	Restart	Defaults	Video	Analog Audio
	Z4K-XSenc	Zyper4KXS	NA	Restart	Defaults	hdmi	hdmi out
	Decoder_1	ZyperUHD	IdleImage	Restart	Defaults	hdmi	analogAudio
	UHDdec	ZyperUHD	IdleImage	Restart	Defaults	hdmi	hdmi out
	Z4Kdec1	Zyper4K	NA	Restart	Defaults	hdmi	hdmi out
	ZVconnTrans	Zyper4K	NA	Restart	Defaults	hdmi	hdmi out

For the desired decoder, select the “**IdleImage**” option. Here you can upload a new background. The uploaded file must meet these requirements.

Size: 1280 x 720 (Firmware 5.6 or older) or 1920 x 1080 (Firmware 5.7 or newer)
 Format: JPEG

Select IdleImage and you can upload a new file or select from a previously uploaded “saved” file. **Important note:** The image file itself cannot have any spaces in the file name.

IdleImage	Power Save	Flash LEDs
Set ✓	Set ✓	Set ✓
IdleImage ▼	Upload File	
IdleImage ▼	Saved Files ▼	
IdleImage ▼	disabled ▼	FlashLE...

?	Model	Secured	IdleImage
			Set ✓
			IdleImage ▼
			IdleImage ▼
			IdleImage ▼

Drop file or Click here

Cancel OK

Once a file is selected, the ZyPerUHD60 unit will reboot itself in order for this change to take effect.

Web Browser Interface

All ZyPerUHD60 Encoders and Decoders can be accessed directly via a web browser interface. Note that this feature is password protected.

Important note: Changes made in browser interface may get overwritten if the ZMP is connected to the system. The ZMP should always be used if possible to make changes to UHD60 configuration.

To access the web browser interface you will need to enter the IP address of the encoder or decoder into the browser address bar. Units can be discovered in a wide range of manners including via UPNP and Bonjour.

The encoder/decoder will require you to login. The default login/password are admin / admin.

Important note: The encoder/decoder will force you to change the password after the first login. It will not allow you to select the current password of “admin” as the new password. You go back in a later an change the password to “admin” if desired. A factory reset of the encoder/decoder will also reset the password.

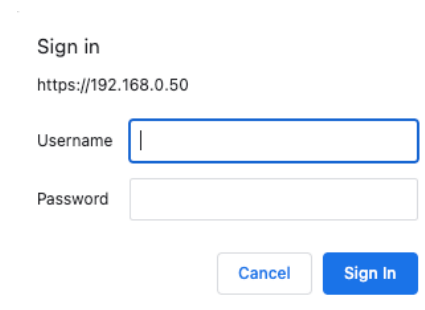

Sign in

https://192.168.0.50

Username

Password

System Information Tab

After login you will be taken to the System Information Tab.

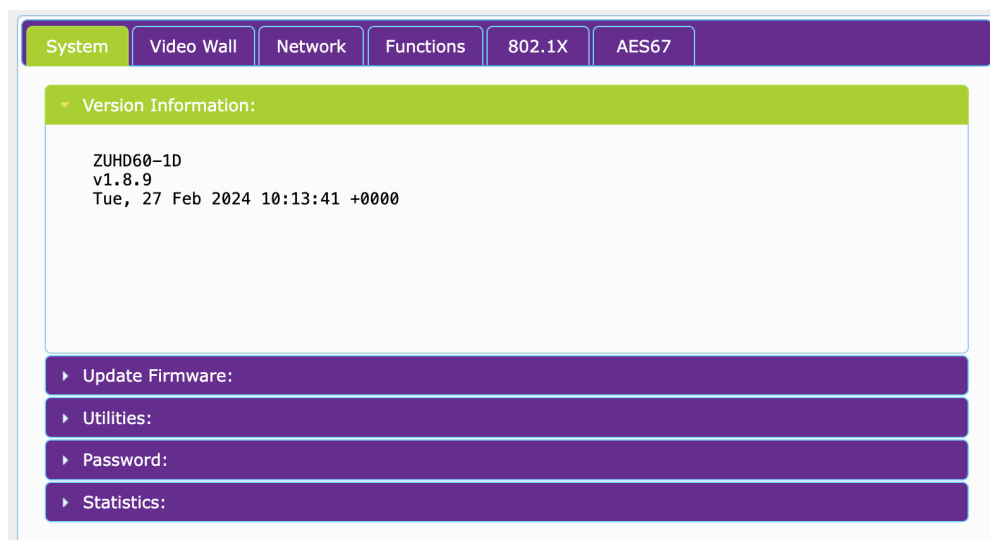

The System Tab will show Version Information by default. In the example above, the unit is a ZUHD60-1D (Single LAN Decoder). Firmware version and date of firmware are also shown here. (This version may not match the version number shown in the ZyPer Management Platform)

The Update Firmware tabs allows you to update the firmware for the encoder or decoder.

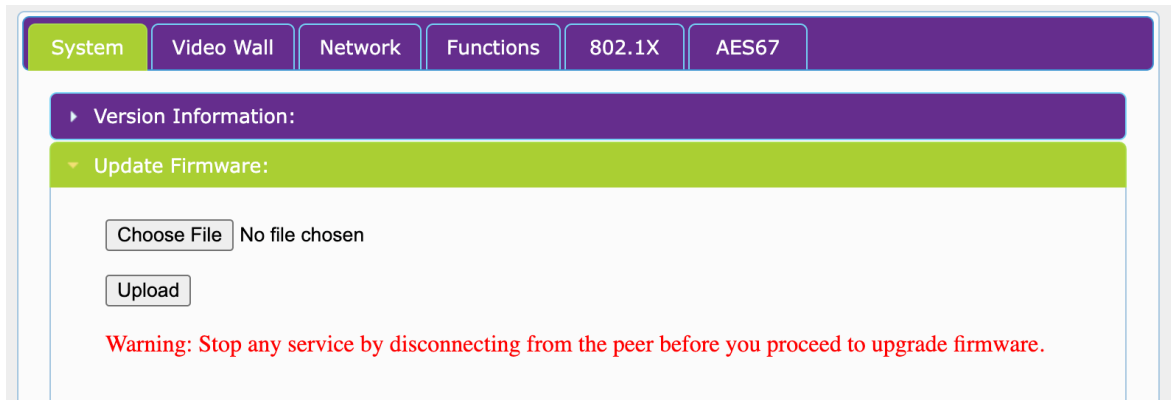

Choose the appropriate firmware update file that you have obtained from ZeeVee and press the Upload button. Note this process will force the encoder or decoder unit to reboot.

Utilities Tab

The Utilities Tab shows some basic information about the unit and allows to change the Device name. You can Factory Default or Reboot of the unit. The **Console API Command** can be used to adjust settings on Dante enabled units. See Dante section later in this document.

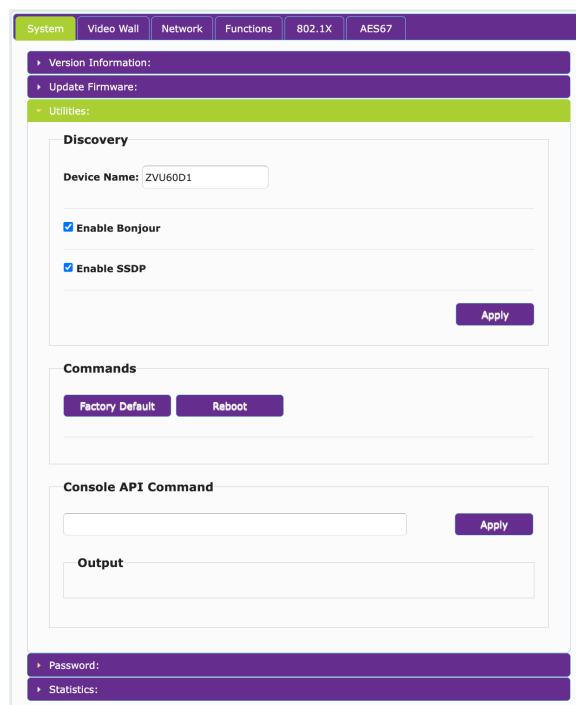

Password Tab

The Password tab will allow you to change the password.

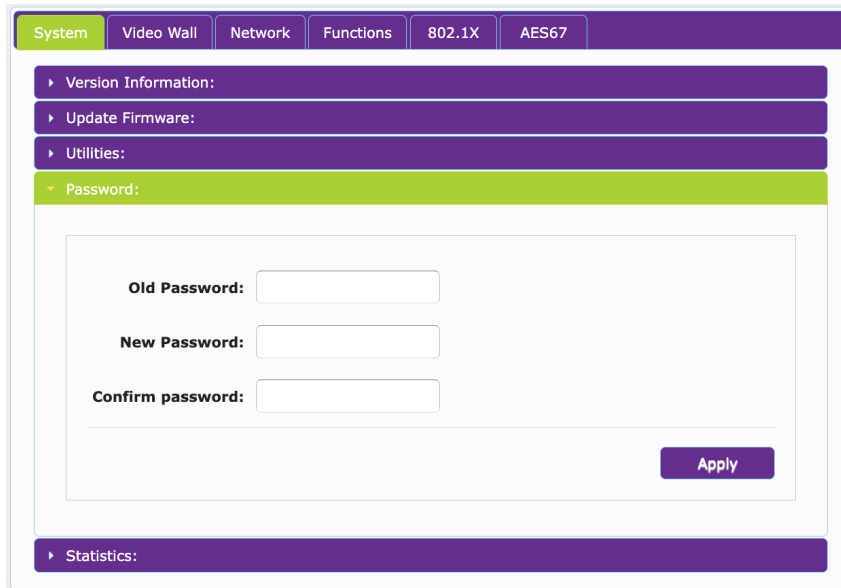

Statistics Tab

The Statistics tab will show you a lot of basic information about the encoder or decoder.

This includes current IP address, MAC address, Status, Output information from a decoder, Input information for an encoder as well as EDID information for the endpoint.

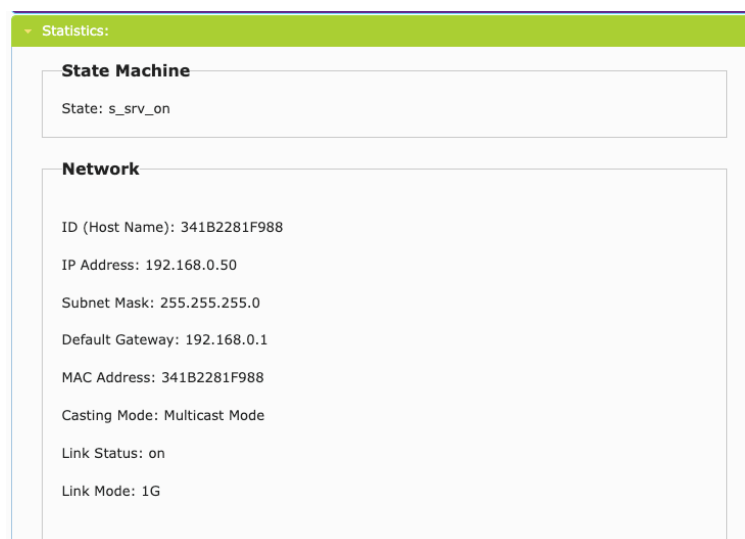

Video Wall Tab

The Video Wall tab is available on the Decoder side only. It allows you to set the size/ configuration of a Video wall and select what display this decoder represents in the wall.

Horizontal and Vertical Monitor Count determine the video wall size. Row Position and Column position determine location in the wall. Note that location 0,0 is the Top Left most position.

Preferences allows you to modify positioning and rotate the image in the wall if desired.

Bezel and Gap Compensation allow modification of borders to correct for display bezels.

The screenshot displays the 'Video Wall' configuration tab within a software interface. The top navigation bar includes 'System', 'Video Wall', 'Network', 'Functions', '802.1X', and 'AES67'. The main content area is titled 'Basic Setup:' and is divided into three sections:

- Bezel and Gap Compensation:** This section contains four input fields for OW, OH, VW, and VH, each with the value '1'. To the right is a diagram of a single monitor panel with dashed lines indicating the overall width (OW), overall height (OH), video width (VW), and video height (VH). Below the diagram, it states 'UNIT: 0.1mm'.
- Wall Size and Position Layout:** This section features four dropdown menus: 'Vertical Monitor Count' (set to 1), 'Horizontal Monitor Count' (set to 1), 'Row Position' (set to 0), and 'Column Position' (set to 0). To the right is a diagram showing a grid of monitor panels with dashed lines indicating the 'Horizontal Monitor Count' and 'Vertical Monitor Count'. Below the diagram, it states 'UNIT: Panel'.
- Preferences:** This section includes two dropdown menus: 'Stretch Type' (set to 'Fit In') and 'Rotate and Flip' (set to '0° Clockwise Rotate').

At the bottom of the configuration area, there is an 'Apply To: "All" device(s) in the list' section with a dropdown menu set to 'All' and an 'Apply' button. Below this is a checkbox labeled 'Show OSD' which is currently unchecked.

Network Tab

The Network tab allows you to set the IP address of the endpoint. Options include Auto IP, DHCP and Static. Default setting is DHCP. Note that if a DHCP server is not found, the units will assign themselves a Link-Local address.

The screenshot displays the Network configuration interface. At the top, there is a navigation bar with tabs: System, Video Wall, Network (highlighted), Functions, 802.1X, and AES67. Below the navigation bar, the interface is divided into two main sections: IP Setup and Casting Mode.

IP Setup

IP Mode: Three buttons are shown: Auto IP, DHCP (highlighted), and Static.

IP Address: 192.168.0.37

Subnet Mask: 255.255.255.0

Default Gateway: 192.168.0.1

An **Apply** button is located at the bottom right of the IP Setup section.

Casting Mode

Two buttons are shown: Multicast (highlighted) and Unicast.

Auto select USB operation mode per casting mode (recommended)

An **Apply** button is located at the bottom right of the Casting Mode section.

Always be careful when assigning Static addresses to units. It is important to never duplicate a Static address.

Function Tab

The Function Tab allows you to enable / disable many features of the encoder or decoder. One important feature of the Decoder is the ability to select the encoder to route video/audio from.

Routing

The connected Encoder (Identified by MAC address is shown here)

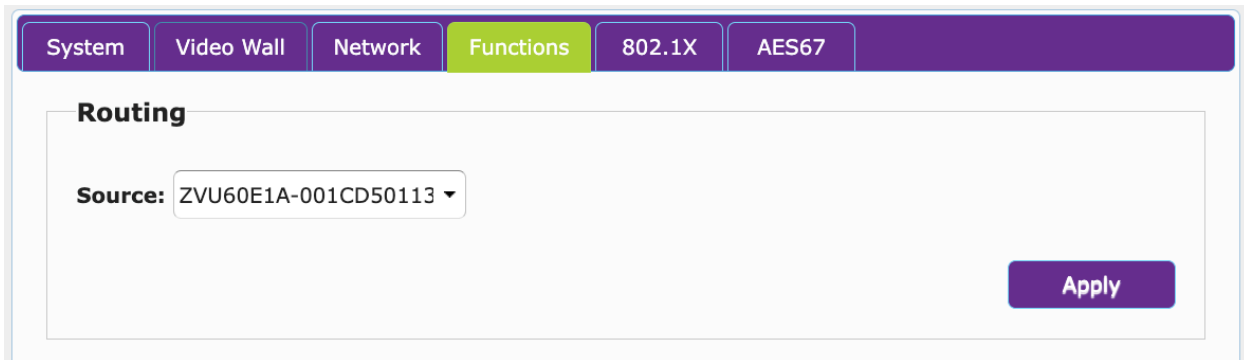

If you click on the small down arrow in this Source box you will bring up a listing of all available encoders on the network. Selecting a different encoder will cause all video/audio/USB etc.. signals to switch to this new encoder.

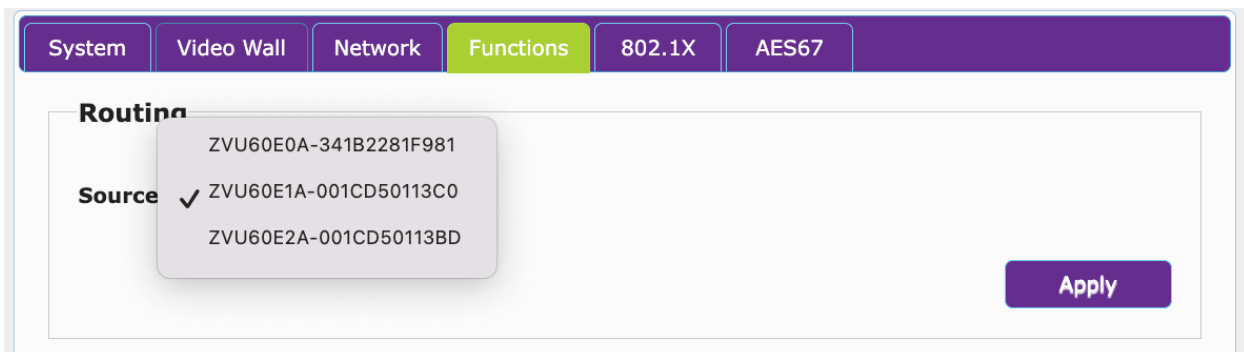

Video over IP

The Video over IP section allows the user to enable or disable certain features. Note that most changes will require a reboot of the encoder/decoder before being implemented.

Turn off screen feature will cause decoder to not output the “Source Not Found” screen.

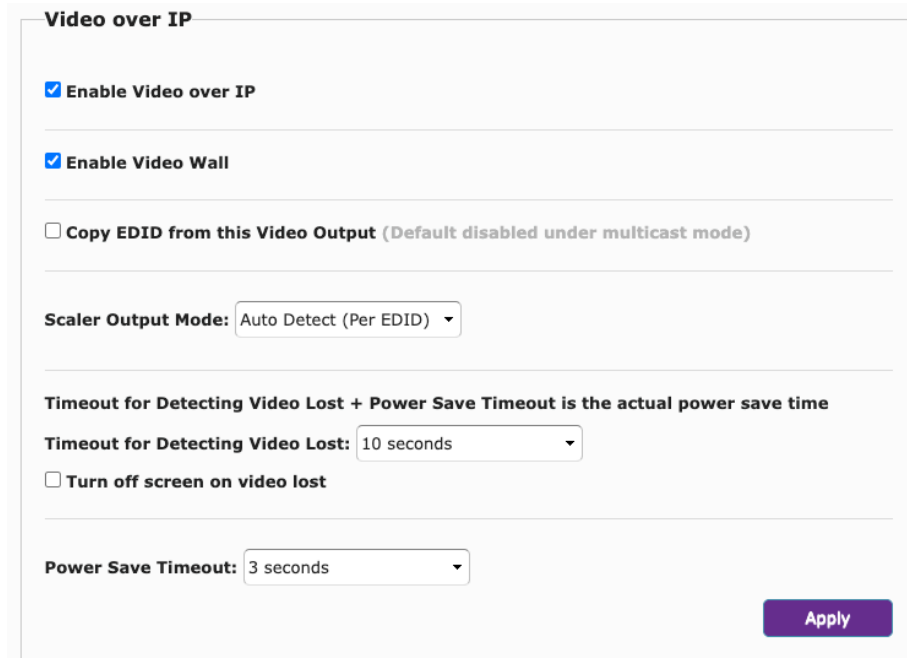

Scaler Output Mode: This feature is used to set the output resolution from the UHD60 Decoder. Default is to use resolution specified by the display EDID. “Auto Detect (Per EDID)”.

The user can manually select other options to force the decoder to ignore the display EDID.

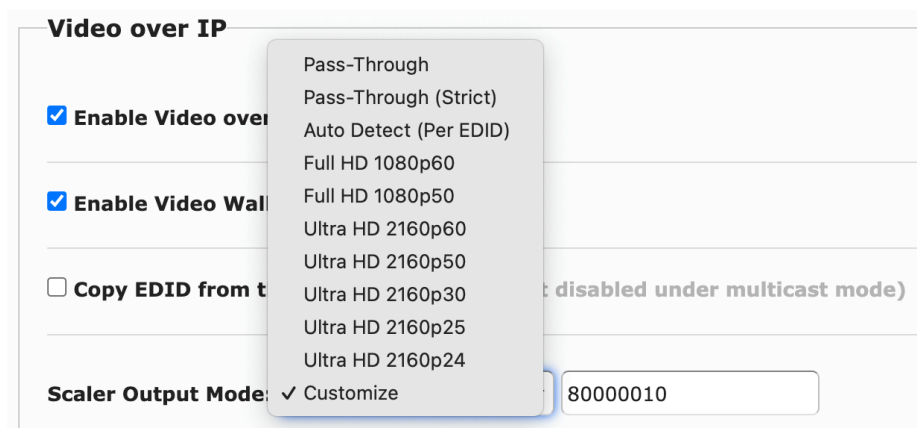

Most of the options are self explanatory for setting a resolution such as Full HD (1920 x 1080) or Ultra HD (3840 x 2160). There is however an option to provide a custom or non-standard resolution. Below is a chart of example options for the *Customize* field.

Setting	Output Resolution
80000004	HD 1280 x 720 @60Hz
80000013	HD 1280 x 720 @50Hz
8000003E	HD 1280 x 720 @30Hz
8000003D	HD 1280 x 720 @25Hz
8000003C	HD 1280 x 720 @24Hz
81004048	WXGA 1366 x 768 @60Hz
81004021	WXGA+ 1440 x 900 @60Hz
81004032	WUXGA 1920 x 1200 @ 60Hz
8100401D	SXGA+ 1400 x 1050 @60Hz
8100404E	Custom 1600 x 900 @ 60Hz

Important Note: The settings above are only valid when a ZyPer Management Platform is NOT connected to the system. The ZMP will automatically override any of the settings above with whatever setting is programmed to the ZMP. Contact ZeeVee support if other custom settings are needed.

USB over IP

This section allows you to make modifications to the USB functionality. Recommended in most cases to leave at defaults.

USB over IP

Enable USB over IP

Operation Mode:

Auto select mode (Recommended, choose per network casting mode)
 Active on link (Unicast network's default mode)
 Active per request (Multicast network's default mode)

Compatibility Mode:

K/M over IP (Uncheck when mouse/keyboard/touch panel not working as expected)

Serial over IP

This section allows you to set the baud rate, data bits, stop and parity bits for serial communications.

Serial over IP

Enable Serial over IP

Operation Mode:

Type 1 (Need extra control instruction. For advanced usage.)

Type 2 (Recommended. Dumb redirection.)

Type 1 guest mode

Type 2 guest mode

Baudrate Setting for Type 2:

Baudrate: 115200

Data bits: 8

Parity: None

Stop bits: 1

Apply

Audio over IP

This section allows you to enable or disable audio as well as enable AES67 functionality.

Audio over IP

Enable Audio Over IP

Enable Audio Return Path

ADDON Configuration:

ADDON Type:

AES67

Audio Output Selection:(Choose which stream to output)

ADDON(Dante/AES67)

Enable ADDON Bridge Mode (ASPEED <--> ADDON)

Apply

802.1X Tab

The 802.1X Tab allows the user to enable and configure 802.1X Authentication. Please note this this feature is intended to be used to experienced Network Engineers that are already familiar with 802.1X.

The screenshot shows the configuration page for 802.1X authentication. The '802.1X' tab is selected in the top navigation bar. The configuration area contains the following elements:

- Configuration** section header.
- Enable 802.1X Authentication**
- Validate Server Certificate**
- CA certificate:** A file selection field with a 'Choose File' button, the text 'No file chosen', and an 'Upload' button.
- Authentication Method:** A dropdown menu currently showing '- Select -'.
- An **Apply** button at the bottom right of the configuration area.

The user can select a Certificate Authority certificate (Provided by the user) and an authentication method.

This screenshot shows the same configuration page as above, but with the following changes:

- Enable 802.1X Authentication**
- Validate Server Certificate**
- The **Authentication Method** dropdown menu is open, displaying the following options:
 - ✓ - Select -
 - EAP-PEAP (MSCHAPv2)
 - EAP-TLS
- The **Apply** button remains at the bottom right.

AES67 Tab

The AES67 Tab allows you to see AES67 Transmitter information for the specific encoder or decoder. It also allows a search for compatible AES67 streams available on the network and if set to Receive mode can allow you to select an AES67 stream to receive.

System
Video Wall
Network
Functions
802.1X
AES67

AES67 Transmitter

AES67 Transmitter information

```

v=0
o=- 164365245 164365246 IN IP4 192.168.0.37
s=-001CD5010965
c=IN IP4 239.69.0.37/15
t=0 0
m=audio 5004 RTP/AVP 98
a=rtpmap:98 L24/48000/2
a=clock-domain:PTPv2 0
a=sync-time:0
a=framecount:48
a=ptime:1
a=ts-refclk:ptp=IEEE1588-2008:00-1C-D5-FF-FE-01-09-65:0
a=mediaclk:direct=0
a=recvonly
                    
```

AES67 Receiver Configuration

Connect To: Connect

Search

AES67 Source SAP Search Result

AES67 RX:

0:192.168.0.31
▼

```

v=0
o=- 1223218293 1223218294 IN IP4 192.168.0.31
s=-001CD50113BD
c=IN IP4 239.69.0.31/15
t=0 0
m=audio 5004 RTP/AVP 98
a=rtpmap:98 L24/48000/2
a=clock-domain:PTPv2 0
a=sync-time:0
a=framecount:48
a=ptime:1
a=ts-refclk:ptp=IEEE1588-2008:00-1D-C1-FF-FE-91-D5-83:0
a=mediaclk:direct=0
a=recvonly
Q
                    
```

Preview Stream

The ZyPerUHD60 encoder has the ability to output a Motion JPEG preview stream. This stream can be accessed easily from a browser. Note this stream does not contain audio.

To view the stream in a browser point the browser to the IP Address of the ZyPerUHD60 encoder with /stream.

Example: <http://192.168.0.61/stream>

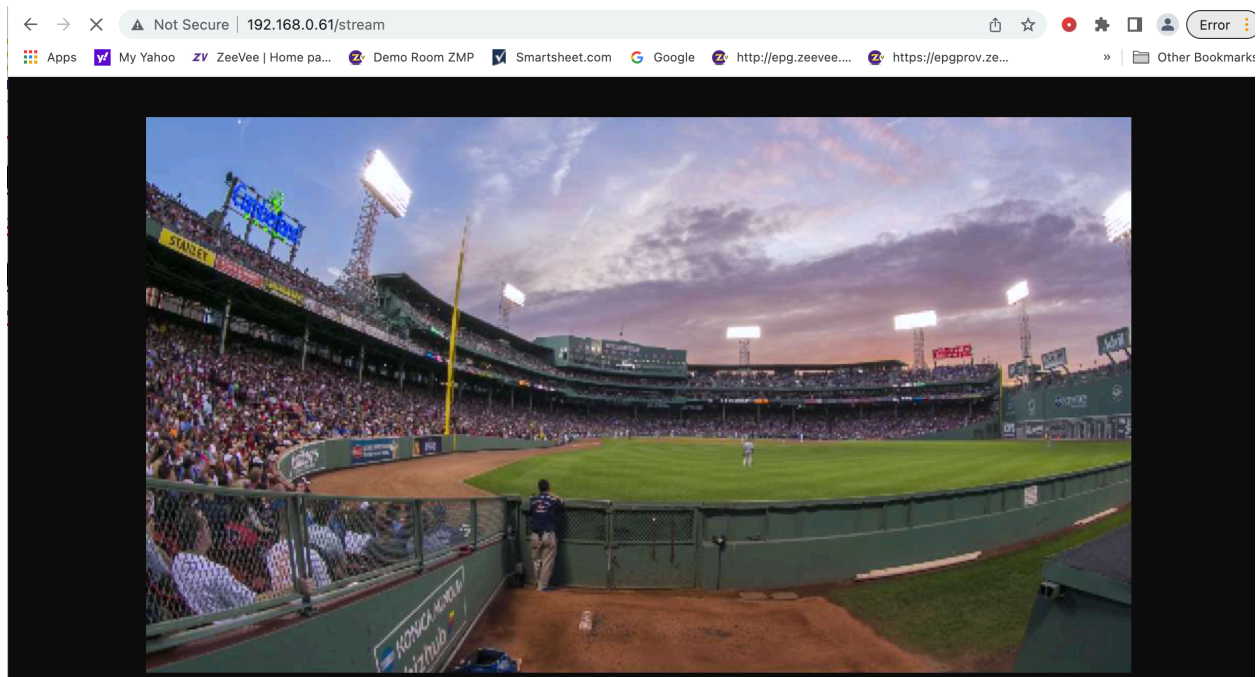

Note: You can also view the stream using VLC

Open Network Stream and enter full address: <http://192.168.0.61/stream> in this case.

Another option for the browser allows you to change the resolution and frame rate of the preview stream. Min/max will depend on input resolution and ability of browser:

Example: <http://192.168.0.61:8080/?action=stream&w=640&h=350&fps=2&bw=1000&as=0>

In this example resolution is 640 x 350 with a frame rate of 2 fps.

HTTP Commands

Introduction

The ZyPerUHD60 supports simple configuration and status access commands using the HTTP protocol. Any HTTP capable application such as web browsers or cURL can be used to issue commands and receive outputs from the unit directly.

Basic Format

Given the IP address of the ZyPerUHD60 unit, the basic command syntax is:

<http://ipaddr/cgi-bin/query.cgi?cmd=xxxx>

ipaddr = IP Address of the encoder or decoder.

Spaces are not allowed in the http command string. They must be replaced with '+' characters.

When using a command shell to invoke utilities such as cURL, the http input string should be encased in quotes. Otherwise, some of the special characters such as '+' may cause problems with the shell interpreter.

General Commands

Note: In example below the application cURL is used to issue commands from a Terminal prompt. The commands can also be entered directly into a browser such as Chrome.

1. Show input/output status of Encoder or Decoder

curl <http://ipaddr/cgi-bin/query.cgi?cmd=gbstatus>

Example on **Encoder**:

```
curl http://192.168.0.75/cgi-bin/query.cgi?cmd=gbstatus
```

```
hdmi in active: true
resolution: 1920x1080
hdmi in frame rate: 60
color space: YCbCr
chroma sampling: 4:4:4
color depth: 8
hdr: SDR
hdcv: none
audio input format: LPCM
audio sample rate: 44.1 KHz
audio bitrate: 2822 Kbps
```

Example on **Decoder**:

```
curl http://192.168.0.52/cgi-bin/query.cgi?cmd=gbstatus
```

```
hdmi out active: true
hdmi out resolution: 3840x2160
hdmi out frame rate: 60
color space: RGB
chroma sampling: 4:4:4
color depth: 8
hdr: SDR
hdcp: 2.2
audio output format: LPCM
audio sample rate: 44.1 KHz
audio bitrate: 2822 Kbps
```

2. Reboot the device

```
curl http://ipaddr/cgi-bin/query.cgi?cmd=reboot
```

Example: `curl http://192.168.0.52/cgi-bin/query.cgi?cmd=reboot`

3. Find Device/Flash Status LED

```
curl http://ipaddr/cgi-bin/query.cgi?cmd=e+e_find_me::X
      X is number of seconds to flash Status LED.
      Range is 0-60. 0 means stop flashing.
```

Example: `curl http://192.168.0.61/cgi-bin/query.cgi?cmd=e+e_find_me::25`

4. RS-232 Serial Control

```
curl "http://ipaddr/cgi-bin/query.cgi?cmd=soip2+-f+/dev/ttyS0+-b+b-dps+-r+-n+-H+-s+"
DATA"
```

b is the baud rate, 115200 recommended

d is number of data bits, usually 8

p is parity, 'n' for none, 'e' for even, 'o' for odd

s is stop bits, usually 1

-r is optional. This specifies a <CR> is appended at the end of the output.

-n is optional. This specifies a <LF> is appended at the end of the output.

DATA is the hex values to send.

Example: send the values "33 44 ab cd", 115200 baud, 8 data bits, no parity, 1 stop bit

```
curl "http://ipaddr/cgi-bin/query.cgi?cmd=soip2+-f+/dev/ttyS0+-b+115200-8n1+-H+-s+"
3344ABCD"
```

Note: There are no spaces between the Hex Data values above. Hex values can use upper or lower case.

Decoder Commands

1. Decoder Join A/V to an Encoder with MAC AABBCCDDEEFF.

```
curl http://ipaddr/cgi-bin/query.cgi?cmd=e+e_reconnect::AABBCCDDEEFF
```

Important Note: Mac Address must be in all Upper Case

Example:

```
curl http://192.168.0.50/cgi-bin/query.cgi?cmd=e+e_reconnect::341B2281F97F
```

Encoder Commands

1. Enable/Disable HDCP. (Note this only changes how the Encoder reports to the connected device. Enabled means the UHD60 tells connected device it supports HDCP 2.2. Disabled means the UHD60 tells the connected device it does not support HDCP at all.)

```
curl http://ipaddr/cgi-bin/query.cgi?cmd=e+e_adj_hdcp::enabled
```

```
curl http://ipaddr/cgi-bin/query.cgi?cmd=e+e_adj_hdcp::disabled
```

Important Note:

Source must already be connected to the UHD60 Encoder for this command to work.

2. Control analog audio direction. Set analog audio port to be an input or output. Does not apply to the UHD60-0E or UHD60-0EA

```
curl http://ipaddr/cgi-bin/query.cgi?cmd=e+e_a_direction::in
```

```
curl http://ipaddr/cgi-bin/query.cgi?cmd=e+e_a_direction::out
```

3. Select Analog audio input or HDMI audio input. Note this command is only valid if both audio sources are connected at the same time.

```
curl http://ipaddr/cgi-bin/query.cgi?cmd=e+e_a_input::hdmi
```

```
curl http://ipaddr/cgi-bin/query.cgi?cmd=e+e_a_input::analog
```

Encoder Commands (UHD60-2E, 2EA and UHD60-2EMP)

1. Switch input to Manual Mode
curl http://ipaddr/cgi-bin/query.cgi?cmd=e+e_v_mode_in::manual
2. Switch input to HDMI1
curl http://ipaddr/cgi-bin/query.cgi?cmd=e+e_v_switch_in::hdmi1
3. Switch input to HDMI2
curl http://ipaddr/cgi-bin/query.cgi?cmd=e+e_v_switch_in::hdmi2
4. Switch input to USB-C
curl http://ipaddr/cgi-bin/query.cgi?cmd=e+e_v_switch_in::usb-c
5. Switch input to Auto Mode
curl http://ipaddr/cgi-bin/query.cgi?cmd=e+e_v_mode_in::auto

Dante AV-A

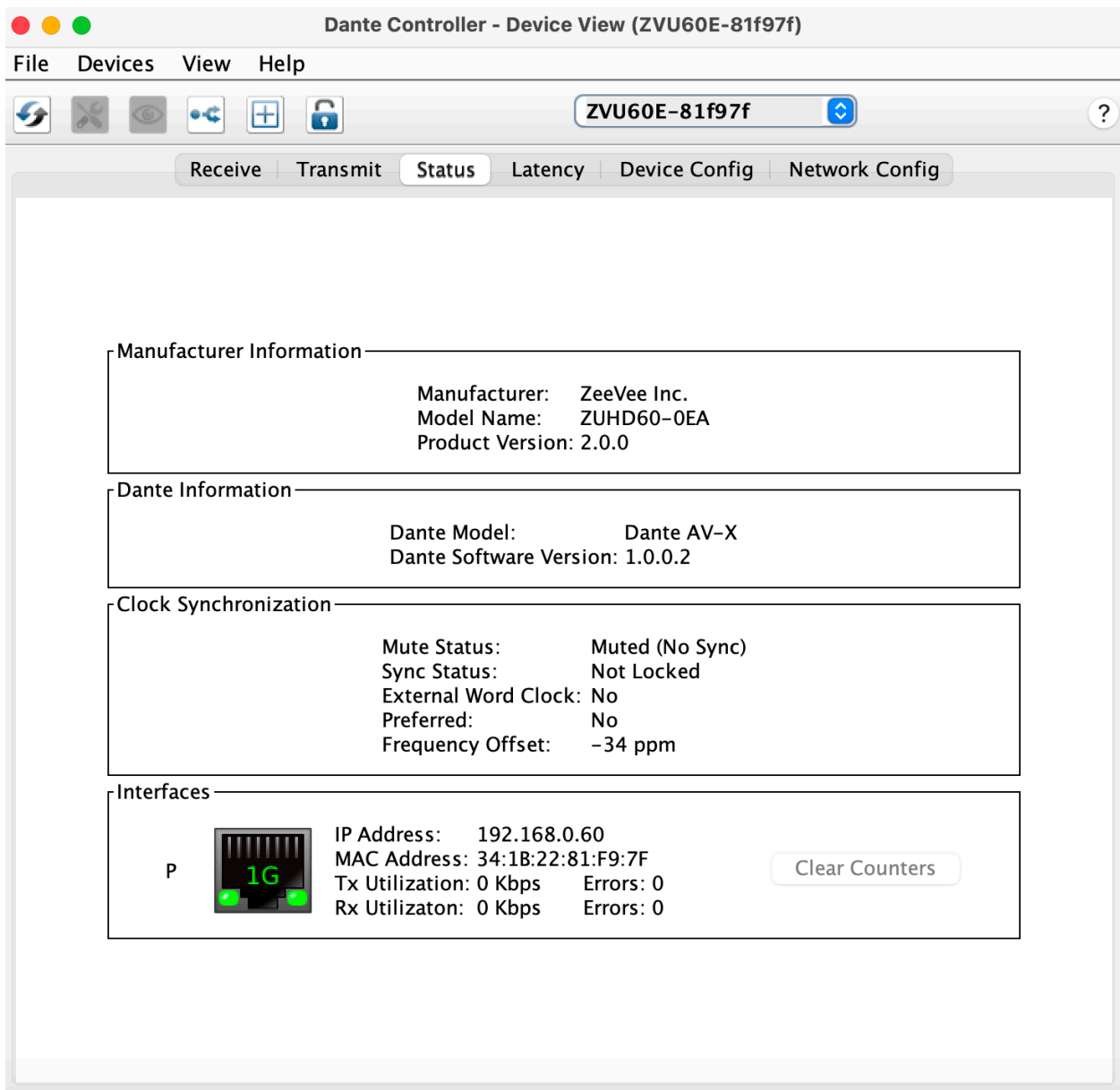

Some ZyPerUHD60 Encoders and Decoders support Dante AV-A. This means every endpoint can be configured to support both Dante transmission and receive functionality.

Feature	Supported/Description
Dante Audio channels	2x2 (input x output)
Sample rate	44.1, 48, 88.2, 96 kHz
Audio format	LPCM only
PCM sample format	Signed 32-bit little endian

UHD60 Encoder	Dante transmitter	HDMI-in or local analogue audio input
	Dante receiver	To UHD60 audio network Note: Cannot extract from encoder analog audio port.
UHD60 Decoder	Dante transmitter	From UHD60 audio network
	Dante receiver	HDMI-out and local analogue audio output.

Important Note

Dante AV-A can be implemented on both single and dual LAN ZyPerUHD60 units. In a single LAN configuration, the Dante function and standard UHD60 AV function share the same LAN. Dante will share the same IP address as the ZyPerUHD60 unit itself. This IP address cannot be changed in Dante Controller.

For a Dual LAN configuration, Dante AV-A requires its own IP Address that is different and independent from the IP Address of the ZyPerUHD60 itself. This could include the Dante AV-A IP address being on a different subnet. Customers that are using a DHCP server to generate IP Addresses must ensure the pool of available IP Addresses accounts for any ZyPerUHD60 endpoints with Dante Embedded in the system.

If no DHCP server is available, Dante AV-A will assign itself a Link-Local address. However, if there is a DHCP server, but there are not enough addresses available in the pool, Dante connections may fail.

Critical Note

For Dual LAN configuration. The Dante LAN port and Primary UHD60 LAN port should never be on the same subnet. This will cause IP conflicts that could result in video not properly flowing on the network. (Note this means that you cannot have both ports set to a Link-Local address. You must manually configure one of the two ports to a different subnet)



Dante Operation

It is expected that the user is familiar with Dante and the use of Dante networks. It is beyond the scope of this document to provide Dante training.

The Dante Transmitter found in the ZyPerUHD60 encoder/decoder will insert the *analog audio* or *HDMI audio* stream that it is receiving onto the Dante Network. Note that the audio must be unencoded/unencrypted. Only raw PCM audio can be inserted onto the Dante network. It is possible the AV video network and the Dante audio network are in fact the same network. It is not possible to route Dante audio traffic from one VLAN onto another VLAN.

By default if only HDMI audio is available, this audio stream will be inserted onto the Dante network. If Analog audio is available via the Analog audio input port; then this audio stream will be inserted onto the Dante network instead of any available HDMI audio.

Network settings are the same as standard ZyPerUHD60 encoders/decoders. Some switches may require additional settings to work with a Dante network. For example the Netgear M4300 series requires settings detailed at the following location:

<https://kb.netgear.com/000060205/M4300-Configuration-Guide-for-Dante-Audio-Devices>

The user should consult the documentation for the switch provider being used.

In Dante Controller the device will appear as a Transmitter and Receiver with the name ZVU60E-YYYYYY (Encoder units) or ZVU60D-YYYYYY (Decoder units)

YYYYYY - Represents the final bytes of the ZyPerUHD60 MAC Address

Note that the device can be renamed in Dante Controller software. A factory reset of the ZyPerUHD60 will restore the default Dante name.

Important Note: ZyPerUHD60 Dante devices should never be made the Dante Clock Leader. Please select another Dante device as the Clock Leader (Preferred Leader)

Below are screen shots from *Dante Controller*.

Important Note: The **Sample Rate** must be set to the correct rate of the incoming audio.

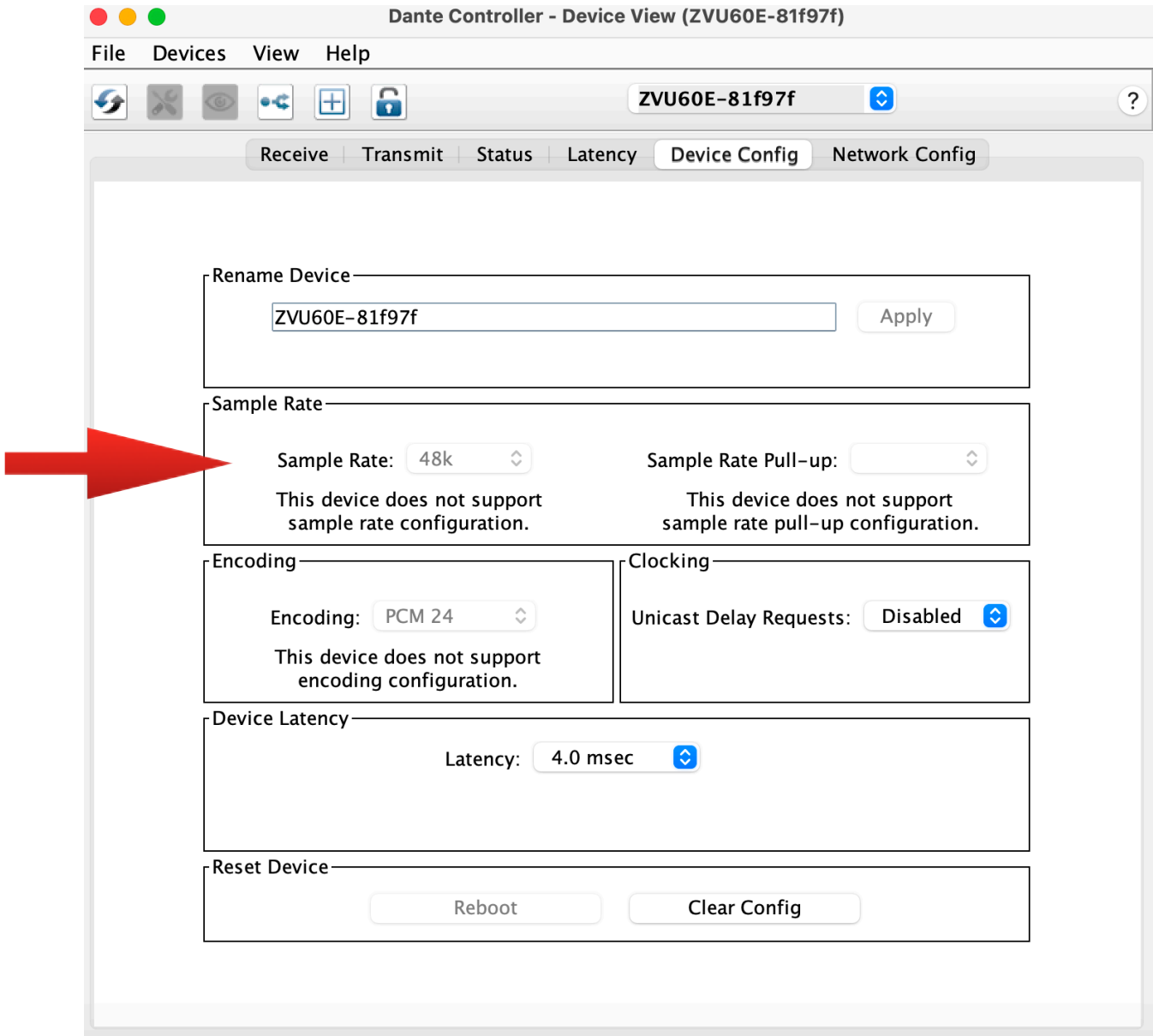

Incorrect setting of the **Sample Rate** field will cause a Dante Transmitter to not see audio as available to transmit.

Incorrect setting of the **Sample Rate** field will cause a Dante Receiver to not receive audio from a Dante Transmitter.

Dante Related Console Commands

The ZyPerUHD60 encoder and decoder units that support Dante can be configured as either a Dante Transmitter or Receiver device. There are various console commands to change this functionality. Note that some commands require a Reboot of the endpoint to be implemented.

Console commands are entered in the System/Utilities tab:

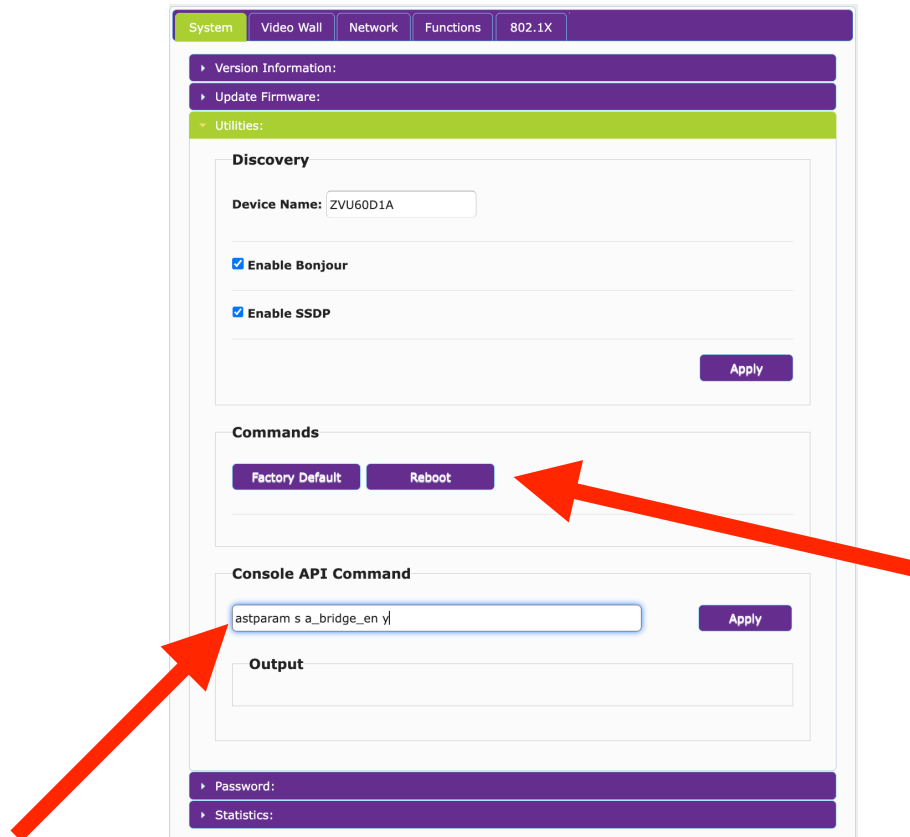

Decoder Dante Commands

1. Set Decoder for Dante Receive function
 - a. `astparam s a_bridge_en n`
 - b. `astparam save`
 - c. Reboot via the Reboot command button
2. Set Decoder for Dante Transmit function
 - a. `astparam s a_bridge_en y`
 - b. `astparam save`
 - c. Reboot via the Reboot command button

3. Set HDMI audio output to the received Dante stream. (RX mode)
 - a. `e e_a_out_src_sel::addon`
 4. Set HDMI audio output to the native stream received from encoder. (TX or RX mode)
 - a. `e e_a_out_src_sel::native`
-

Encoder Dante Commands

1. Set Encoder to Dante Transmit mode
 - a. `astparam s a_bridge_en n`
 - b. `astparam save`
 - c. Reboot via the Reboot command button
2. Audio Select in Transmit mode (Default is Auto)
 - a. `e e_a_input::SOURCE`
SOURCE values can be “auto | hdmi | analog”
3. Set Encoder to Dante Receive mode. (Receive Dante and output to UHD60 domain)
 - a. `astparam s a_bridge_en y`
 - b. `astparam save`
 - c. Reboot via the Reboot command button

Note: If Encoder is in the Receive mode, the UHD60 will not have any audio feed to send unless the encoder is actively receiving Dante audio from another source.

Important Notes:

The following command can be used on either an encoder or decoder to check the status of the a_bridge_en setting. Please note the setting is reversed between an encoder and a decoder.

```
astparam g a_bridge_en
```

This will report back either “y” or “n”

Console API Command

Output

```
y
```

a_bridge_en setting	UHD60 Encoder	UHD60 Decoder
y	Dante Receiver	Dante Transmitter
n	Dante Transmitter	Dante Receiver

Dual Ethernet Port Dante Commands

The dual ethernet port ZyPerUHD60 encoder and decoder units that support Dante can be configured to have the Dante transport stream output on either ethernet port.

Note that both ports can be independent LANS or part of the same LAN.

The Ethernet ports are identified as either “eth0” or eth1”
eth0 is the primary 1G PoE port on the ZyPerUHD60-2EA or 2DA unit.
eth1 is the secondary 1G port on the ZyPerUHD60-2EA or 2DA unit.

By default and after a factory reset, the Ethernet ports are independent LANs and Dante will be located on the eth1 port. Both ethernet ports are set to DHCP after a factory reset. If DHCP server is not available, the ports will both take Link-Local Addresses.

Critical Note

For Dual LAN configuration. The Dante LAN port and Primary UHD60 LAN port should never be on the same subnet. This will cause IP conflicts that could result in video not properly flowing on the network. (Note this means that you cannot have both ports set to a Link-Local address. You must manually configure one of the two ports to a different subnet)

There are various console commands to change this functionality. Note that some commands require a Reboot of the endpoint to be implemented.

Console commands are entered in the System/Utilities tab:

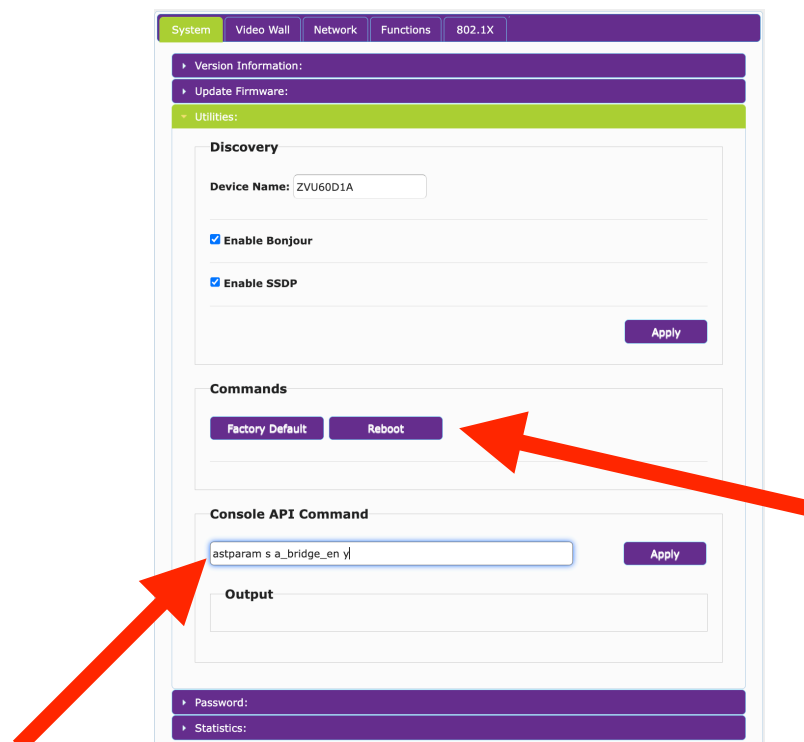

Dual Port Dante Commands

1. Set IP Address Mode of “eth1” port
 - a. `astparam s dante_ip_mode MODE`
MODE values can be “static | dhcp”
 - b. `astparam save`
 - c. Reboot via the Reboot command button

2. Set Static IP Address of “eth1” port (Assumes mode is set to Static above)
 - a. `astparam s dante_ipaddr IPADDRESS`
 - b. `astparam s dante_netmask NETMASK`
 - c. `astparam save`
 - d. Reboot via the Reboot command button

3. Set Dante port to either “eth0” or “eth1”
 - a. `astparam s dante_port PORT`
PORT value can be “eth0 | eth1”
 - b. `astparam save`
 - c. Reboot via the Reboot command button

Example of setting the port and IP address for Dante operation on “eth1”

```
astparam s dante_ip_mode static
```

```
astparam s dante_ipaddr 192.168.0.25
```

```
astparam s dante_netmask 255.255.255.0
```

```
astparam s dante_port eth1
```

```
astparam save
```

reboot via the reboot command button.

Important Notes

If the Dante port is set to eth0, the IP Address is always set via the normal procedure either in the ZyPer Management Platform or the Network Tab of the Web Browser Interface.

The Dante IP Address cannot be set from Dante Controller.

The following command can be used on either an dual LAN encoder or dual LAN decoder to check the status of the dante_port setting.

astparam g dante_port

Console API Command

Output

```
eth0
```

The command *astparam dump* will provide an output of many settings.

Console API Command

Output

```
CRC = 0xE87A8DD7
web_ui_cfg=nexvausrb
dante_ip_mode=dhcp
dante_ipaddr=169.254.35.22
dante_netmask=255.255.0.0
soip_feedback_ip=0.0.0.0
soip_feedback_port=11000
ip_mode=static
ipaddr=192.168.0.65
netmask=255.255.255.0
gatewayip=192.168.0.1
dante_backup_config=H4sIAAAAAACA+2Uv27DIBCHmXkK8gBNfQbjrVOVKWN25NoksmoMwh/
dante_port=eth0
v_switch_mode=auto
v_switch_in=hdmi1
v_switch_pri=hdmi1:hdmi2:usb-c
a_io_select=hdmi
```

AES67

Every ZyPerUHD60 encoder or decoder can be configured as an AES67 endpoint. Encoders can act as AES67 Transmitters and Decoders can act as AES67 Receivers.

Important note: ZyPerUHD60 endpoints must be on firmware revision 5.7.1 or higher to enable AES67 functionality. ZyPer Management Platform must be on version 3.2.40013 or later.

If using ZyPer Embedded Management Platform(ZyPerUHD60-2EMP) It must be on version 3.2.1.40008 and all endpoints must be on firmware version 5.8 or higher.

Wallplate Encoders must be on version 5.9 or higher.

Currently AES67 is only supported via the primary Ethernet port. The secondary utility port cannot be configured as a separate LAN for purposes of AES67.

If no ZMP is being used in the deployment, please contact the ZeeVee support team (support@zeevee.com) to obtain the needed Firmware updates.

Configuring Encoders for AES67

Any ZyPerUHD60 encoder can be configured to be an AES67 transmitter. Note this is in addition to being able to route normal UHD60 audio traffic to any UHD60 decoder.

Use the following steps to configure the encoder for AES67 mode.

Enter the Encoder browser GUI interface using the appropriate IP address for the encoder and then username and password.

Select the “Functions” Tab.

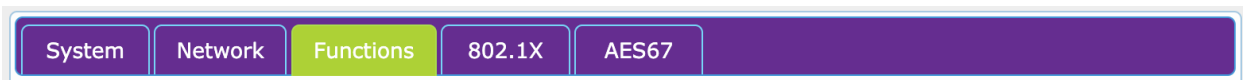

Scroll down to the bottom of the this window to the “Audio over IP” section.

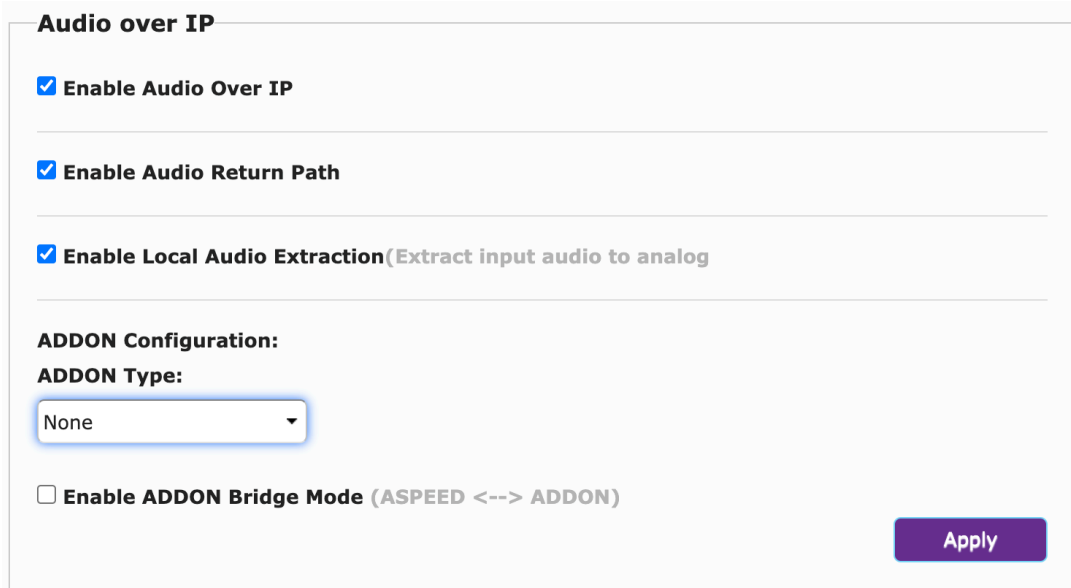

Audio over IP

Enable Audio Over IP

Enable Audio Return Path

Enable Local Audio Extraction (Extract input audio to analog)

ADDON Configuration:
ADDON Type:
None

Enable ADDON Bridge Mode (ASPEED <--> ADDON)

Apply

Change the ADDON Type from None to AES67

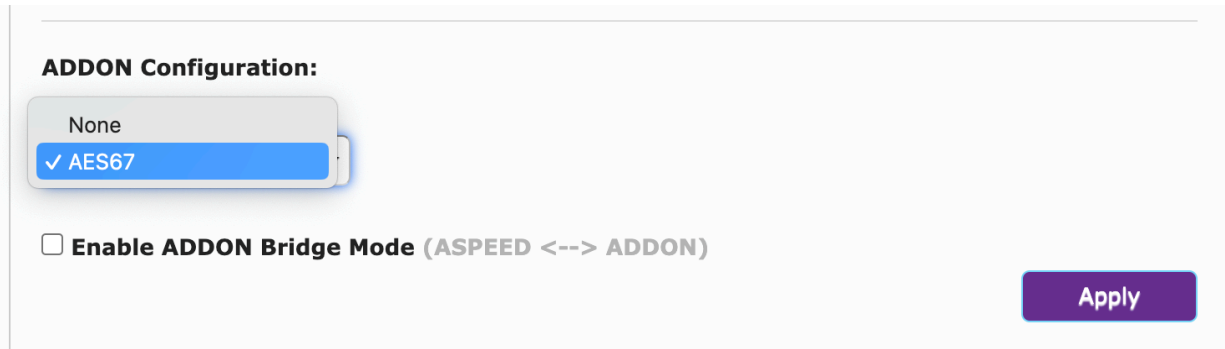

ADDON Configuration:

None
✓ AES67

Enable ADDON Bridge Mode (ASPEED <--> ADDON)

Apply

Click the Apply button

Now switch to the “System” Tab.



System Network Functions 802.1X AES67

Then to the “Utilities” section.



System Network Functions 802.1X AES67

▸ Version Information:

▸ Update Firmware:

▾ Utilities:

Issue the command “astparam save” and hit the Apply button.

Console API Command

Output

Now hit the “Reboot button” in the Commands area of the “Utilities” section

Commands

After the ZyPerUHD60 Encoder reboots it will be in AES67 Transmit mode. You can now go the AES67 Tab to see information related to the AES67 Transmitter. SAP data dump.

System
Network
Functions
802.1X
AES67

AES67 Transmitter

AES67 Transmitter information

```

v=0
o=- 95909825 95909826 IN IP4 192.168.0.3
s=-001CD50113C0
c=IN IP4 239.69.0.3/15
t=0 0
m=audio 5004 RTP/AVP 98
a=rtpmap:98 L24/48000/2
a=clock-domain:PTPv2 0
a=sync-time:0
a=framecount:48
a=ptime:1
a=ts-refclk:ptp=IEEE1588-2008:00-1D-C1-FF-FE-91-D5-83:0
a=mediaclk:direct=0
a=recvonly
                    
```

Important Notes: If the ZyPerUHD60 is a Dante unit; enabling AES67 mode will disable Dante function. The unit can be Dante or AES67 but it cannot be both.

Encoder units can only be AES67 transmitters. They cannot be AES67 receivers.

Configuring Decoders for AES67

Use the following steps to configure the decoder for AES67 mode.

Enter the Decoder browser GUI interface using the appropriate IP address for the decoder and then username and password.

Select the “Functions” Tab.

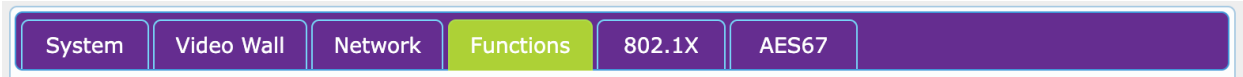

Scroll down to the bottom of the this window to the Audio over IP section.

Audio over IP

Enable Audio Over IP

Enable Audio Return Path

ADDON Configuration:

ADDON Type:

None ▼

Audio Output Selection: (Choose which stream to output)

Native Format ▼

Enable ADDON Bridge Mode (ASPEED <--> ADDON)

Apply

Change the ADDON Type to AES67 and the Audio Output Selection to ADDON/(Dante/AES67) and hit the Apply button.

Important Note: If you route normal UHD60 audio data from a UHD60 encoder to the decoder it will automatically change the Audio Output Selection back to Native Format. It would be wise to configure all joins via the API to be “Video Only” if using AES67 audio.

ADDON Configuration:

ADDON Type:

AES67 ▼

Audio Output Selection: (Choose which stream to output)

ADDON(Dante/AES67) ▼

Enable ADDON Bridge Mode (ASPEED <--> ADDON)

Apply

Now switch to the “System” Tab.

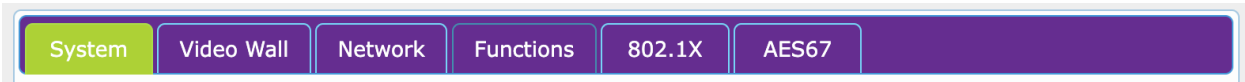

Then to the “Utilities” section.

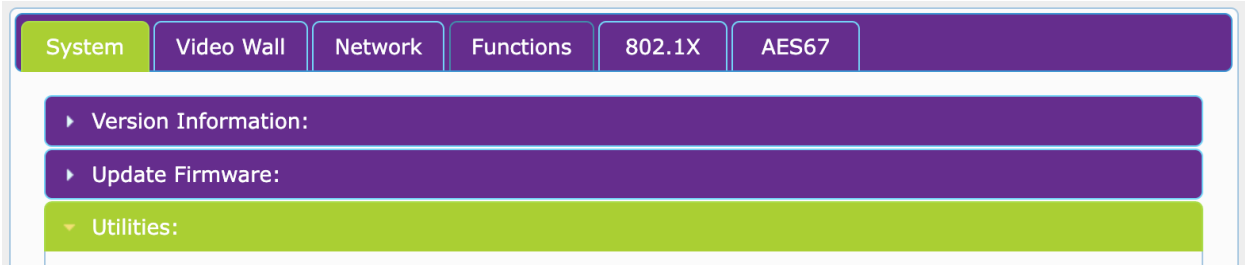

Issue the command “astparam save” and hit the Apply button.

Console API Command

astparam save

Apply

Output

Now hit the “Reboot button” in the Commands area of the “Utilities” section.

Commands

Factory Default Reboot

After the ZyPerUHD60 Decoder reboots it will be in AES67 Receive mode. You can now go the AES67 Tab to see information related to the AES67 Receiver.

System Video Wall Network Functions 802.1X **AES67**

Skip past the Transmitter information as the UHD60 Decoder does not act as an AES67 transmitter.

Go to the AES67 Receiver Configuration.

AES67 Receiver Configuration

Connect To: **Connect**

Search

AES67 Source SAP Search Result

AES67 RX:

N/A

Here you can search for any AES67 streams available on the network. Note that any streams must have appropriate SAP to be discovered by the UHD60 Decoder.

In the example below; the UHD60 Decoder has discovered three available AES67 streams.

AES67 Source SAP Search Result

AES67 RX:

- ✓ - Select -
- 0:192.168.0.3
- 1:192.168.0.5
- 2:192.168.0.17

To have a stream received by the UHD60 Decoder you need to connect to it. Manually type in the IP address of the stream and press the Connect button.

AES67 Receiver Configuration

Connect To:

AES67 Source SAP Search Result

AES67 RX:

```
v=0
o=- 1307654290 1307654291 IN IP4 192.168.0.5
s=-001CD50113BD
c=IN IP4 239.69.0.5/15
t=0 0
m=audio 5004 RTP/AVP 98
a=rtpmap:98 L24/48000/2
a=clock-domain:PTPv2 0
a=sync-time:0
a=framecount:48
a=ptime:1
a=ts-refclk:ptp=IEEE1588-2008:00-1D-C1-FF-FE-91-D5-83:0
a=mediaclk:direct=0
a=recvonly
```

Important Notes: If the ZyPerUHD60 is a Dante unit; enabling AES67 mode will disable Dante function. The unit can be Dante or AES67 but it cannot be both.

Decoder units can only be AES67 receivers. They cannot be AES67 transmitters.

Mounting Brackets

The ZyPerUHD60 units come with mounting brackets in the box. These brackets can be used to securely attach a ZyPerUHD60 to a wall, ceiling, table etc.. It is up to the installer to provide the appropriate screws or bolts to affix the unit to whatever surface it is to be mounted.

Remove the 2 brackets and 4 screws from the package



Mount the brackets on either side of the ZyPerUHD60 unit using provided screws.

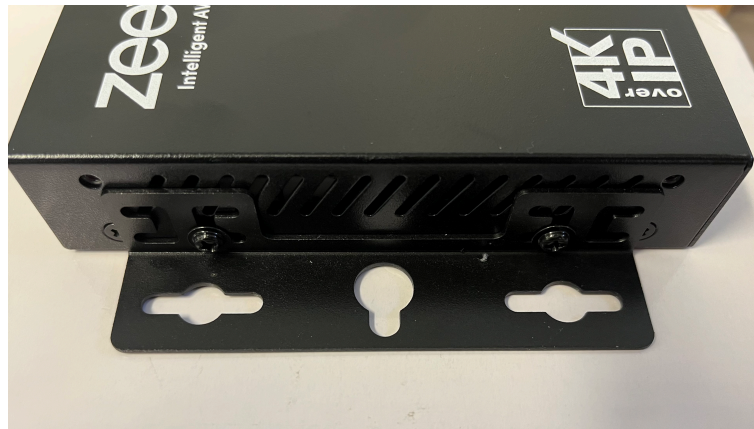

Power Save Mode

The ZyPerUHD60 decoders can be put into a power save mode when not receiving an active stream. By default when not receiving a video stream the decoder will output a backslash screen indicating no source found. This can be disabled by entering power saving mode. This will disable all video output.

Note: This functionality is often needed when connecting a ZyPerUHD60 decoder to a Zoom or Teams room hardware. These devices require the decoder output to completely discontinue output after a call is ended.

The command is found in the ZyPer Management Platform User Guide.

Syntax

```
set decoder id powerSave arg
```

id is the identification of the Decoder
arg is the argument. Either enabled or disabled.

Examples:

```
set decoder UHD60dec powerSave enabled
set decoder UHD60dec powerSave disabled
```

Power Save mode can also be set using the ZyPer Management Platform GUI. (Version 3.0 or greater) The setting can be found in the Display Grid - Config Tab.

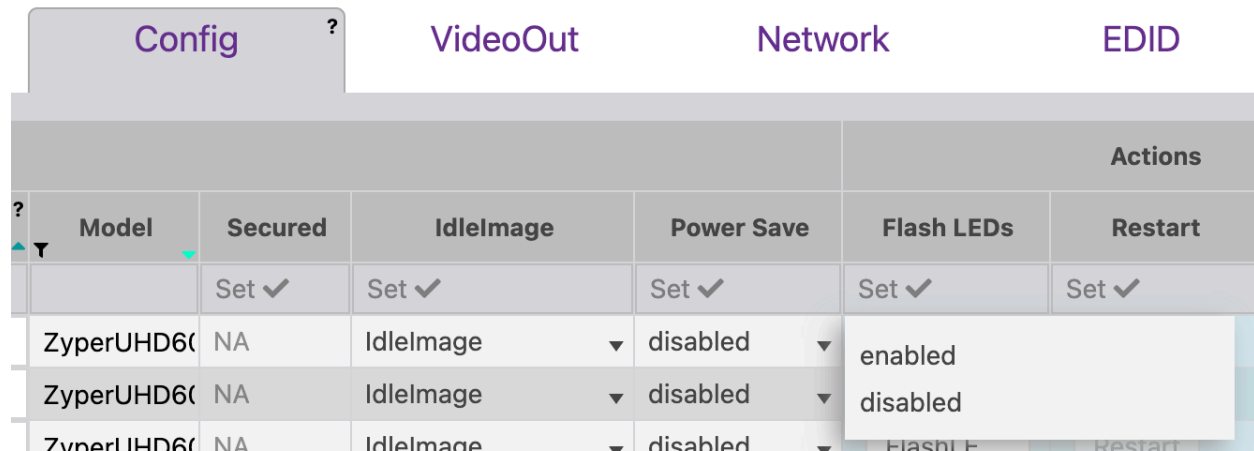

Config						VideoOut	Network	EDID
							Actions	
Model	Secured	IdleImage	Power Save	Flash LEDs	Restart			
ZyperUHD60	Set ✓	Set ✓	Set ✓	Set ✓	Set ✓			
ZyperUHD60	NA	IdleImage	disabled	enabled				
ZyperUHD60	NA	IdleImage	disabled	disabled				
ZyperUHD60	NA	IdleImage	disabled	Flash LEDs	Restart			

Switch Requirements

When the ZyPerUHD60 series deliver video, transfer rates can vary between 400 Mbps and 900 Mbps, which requires a gigabit Ethernet switch. (Data rates and compression depend on the resolution, color space and refresh rate of the input video stream.)

Switches must support the following features:

- Multicast forwarding or filtering
- IGMP Snooping
- IGMP snooping fast leave
- Jumbo frame(9000 bytes or larger)

Configure switches features based on the table below:

Feature of Switch	Parameters
Green or energy-saving feature	Disable
Multicast forwarding or filtering	Enable
IGMP Snooping	Enable
IP address of IGMP Querier	Must be assigned a valid value
IGMP Querier	Disable
IGMP snooping fast leave	Enable
Validate IGMP IP Header	Disable
Dynamic multicast router port	Disable
Jumbo Frame or (Frame Size)	Enable or set to 9000 bytes or larger

Note: Different brands of models of switches may have different names of the previous features.

Configuring the ZyPerUHD60-2EMP

The ZyPerUHD60-2EMP has a built in ZyPer Management Platform (ZMP) capable of configuring and controlling **up to 20 ZyPer endpoints**.

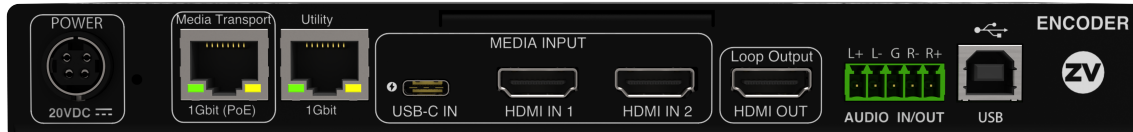

The ZMP within the ZyPerUHD60-2EMP has the same functionality as any other form factor ZMP as well as the functionality of a UHD60 Encoder. (Except for the V.A.M. feature)

The ZyPerUHD60-2EMP must be plugged into the Video Network using the primary Media Transport 1Gbit (PoE) port.

The ZMP does not have a default IP Address. It will either acquire an IP Address from the local DHCP Server or it will take a Link-Local address.

From a command prompt you can find the IP Address of the integrated ZMP by using the command ***ping zyper.local***

Example:

```
TC157:~ artweeks$ ping zyper.local
PING zyper.local (192.168.0.24): 56 data bytes
64 bytes from 192.168.0.24: icmp_seq=0 ttl=64 time=3.285 ms
```

In the example above, the ZMP has been discovered and has an IP Address of 192.168.0.24

Please consult the ZyPer Management Platform User Guide for additional details on configuring the ZMP.

<https://www.zeevee.com/documentation/>

Important Note: The ZyPerUHD60-2EMP comes with firmware version 5.8 installed. You must update all encoders and decoders in the system to version 5.8 or newer to maintain compatibility with the ZyPerUHD60-2EMP.

Setting up ZyPerUHD60

A many to many, or switched environment involves connecting many sources to many displays. ZyPerUHD60 allows you a flexible and scalable amount of input-output options without limitations.

For example, in a 24-port configuration, you can configure a 1x23, 6x18, or 4x20 (and so on) system. A network switch is needed in these many to many configurations. These environments also require configuration through the ZyPerUHD management software.

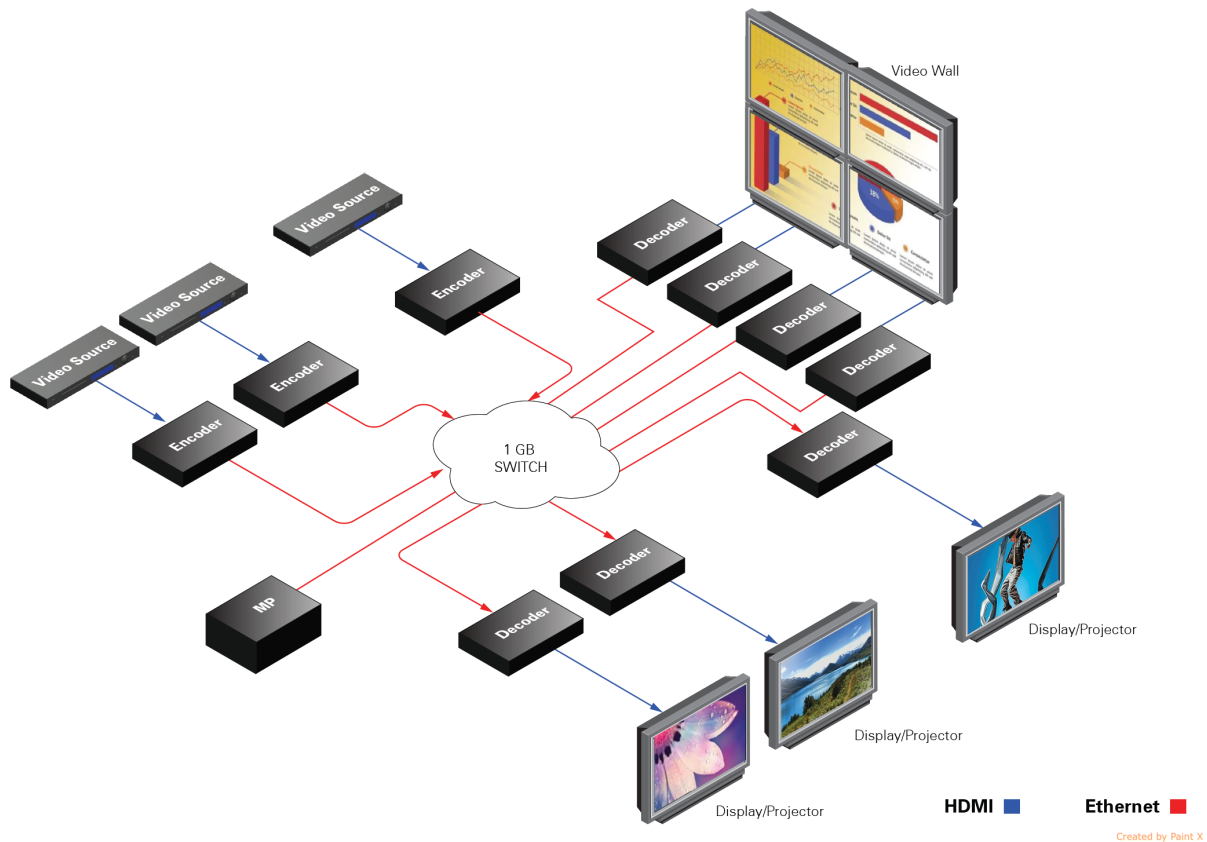

To set up ZyPerUHD60 in a many to many environment, you have to:

- Install ZyPerUHD60 management software (Optional in some configurations)
- Connect all Encoders and Decoders to the 1Gb network switch
- Switch (or route) video from sources to displays

Please consult the *ZyPer Management Platform User Manual* for additional details on switching/routing video from sources to displays.

<https://www.zeevee.com/documentation-all-products>

To set up ZyPerUHD60 in a point-to-point environment, you have to:

- Connect the Encoder and Decoder to each other via the network cable. Video and audio will automatically begin streaming.

USB Details

The ZyPerUHD60 provides for USB-over-LAN communications.

The ZyPerUHD60 Encoder contains a USB Hub while the ZyPerUHD60 decoder contains a USB Host.

Device types include the following:

USB Keyboard
 USB Mouse
 USB Touch Panels
 USB Cameras
 USB Pen Table & Signature Pad
 USB Card Readers
 USB Flash Memory
 USB Hard Disk
 USB CD-ROM

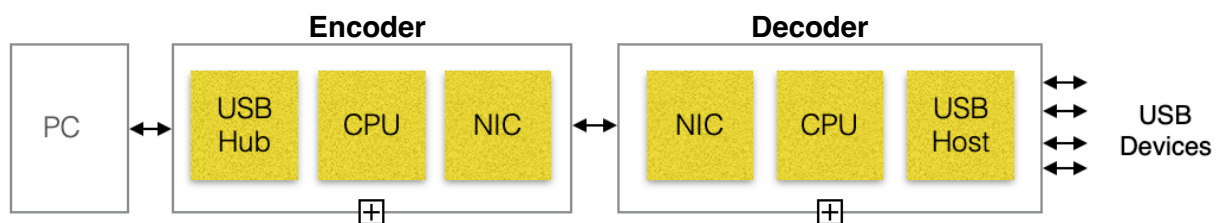

A ZyPerUHD60 System can support an unlimited number of decoders connected to an encoder for USB Connections. However, there are practical and bandwidth limitations based on the 1G network.

The maximum number of USB Hops allowed is 7. However the ZyPerUHD60 itself counts as 2 Hops making the real Hop limit = 5.

Note: Only the UHD60 Encoder counts against Hop limit. Encoder = 2 Hops, Decoder = 0 Hops.

Device Technical Specifications

Encoder and Decoder HDMI Video Specifications

All encoders and decoders have at least one exposed HDMI port. There is an input and output on the encoder and an output on the decoder. All the parameters in terms of the formats of video and audio carried are the same for either.

HDMI	ZyPerUHD60		
	Enc	Dec	
HDMI Standard Port	✓	✓	HDMI 2.0 with HDR and HDCP2.3 Support
Direction	✓		Input
	✓	✓	Output
Connector	✓	✓	Type-A receptacle (female)
HDMI Resolutions	✓	✓	<p>Supports all major VESA resolutions and variations including:</p> <p>640x480 (p/i) 720x576 (25Hz/50Hz)(p/i) 800x600 (p) 1024x768 (p) 1280x720 (p/i) 1280x1024 (p) 1366x768 ⊕ 1440x1080 (p) 1600x1200 (p) 1920x1080 (p/i) 3440x1440 (p) 3840x2160 (p) 4096x2160 (p)</p> <p>Note: 3840x2160@60Hz 4:4:4 for encoder inputs Note: 3840x2160@60Hz 4:4:4 for decoder outputs</p> <p>all at 24/25/29.97/30/50/59.94/60Hz refresh rates except where noted.</p>
HDMI Audio	✓	✓	<p>Encoded audio format and LPCM2.0/LPCM2.1/ LPCM5.1/LPCM 7.1</p> <p><i>Additional restrictions may result from the audio supported at encoder's input.</i></p>

Physical and Environmental

The following parameters apply to all encoders and decoders unless specifically stated otherwise.

Type	Parameter
A/C Adapter	100-1240VAC 50-60Hz 0.7-0.45A draw on AC Mains Output Max: 12VDC 2.0A Output Max: 20VDC 6.0A (1WE, 2E, 2EA and 2EMP models only)
Encoder power consumption	7-9W Powered via either PoE or power adapter. Power consumption of 1WE, 2E, 2EA and 2EMP up to additional 60W if supplying power out the USB-C port.
Decoder power consumption	7-8W in normal operation. Up to 13W max if powering USB devices. Powered via either PoE or power adapter.
Dimensions	Encoder/Decoder: 215mm Wide x 120mm Deep x 25mm High Wall-plate Encoder: Standard 2-Gang box size 91mm Wide x 105.6mm High x 40mm Deep
Weight	705 grams
Operating Temperature	0° C to +45° C (32° F to 113° F)
Non-Operating Temp	-20° C to +70° C (-4° F to +158° F)
Humidity (op/ storage)	10% to 90% (Non-Condensing)
ESD Protection	HBM +/- 8 kV (air-gap discharge) +/- 4 kV (contact discharge)
Surge Protection	Voltage: +/- 1kV
Group Pulse Protection	Voltage: +/- 2kV
Certification	CE, FCC, RoHS compliant

General Safety and Care Instructions

Safety

WARNING: When using electronic products, basic precautions should always be followed, including:

- Keep these instructions.
- Heed all warnings.
- Follow all instructions.
- Do not use this apparatus near water.
- Clean only with in accordance with cleaning instructions included in this manual.
- Do not block any ventilation openings. Install in accordance with the manufacturer's instructions for spacing and clearance to allow proper airflow.
- Do not install or place this product near any heat sources such as radiators, heat registers, stoves, or other apparatus (including amplifiers) that produce heat.
- Do not defeat the safety purpose of the grounding-type plug. A grounding type plug has two blades and a third grounding prong. The third prong is provided for your safety. If the provided plug does not fit into your outlet, consult an electrician for replacement of the obsolete outlet.
- Power cord must be accessible to allow for the removal of the power from the unit.
- Protect the power cord from being walked on or pinched, particularly at plugs, convenience receptacles, and the point where cords exit from the apparatus.
- Unplug this apparatus during lightning storms.
- Unplug this apparatus when unused for long periods of time.
- Only use attachments/accessories supplied or specified by the manufacturer.
- Refer all servicing to qualified service personnel. Servicing is required when the apparatus has been damaged in any way, such as power-supply cord or plug is damaged, liquid has been spilled or objects have fallen into the apparatus, the apparatus has been exposed to rain or excessive moisture, does not operate normally, or has been dropped.



WARNING: To reduce the risk of fire or electric shock do not operate this apparatus in a position where it is exposed to dripping or splashing liquids, rain, moisture, or excessively high humidity. Objects containing liquid shall not be placed in proximity to the unit such that they present a risk of spillage onto the apparatus.

Shock and Fire Hazard:

The unit's metal case, power supply, and grounding terminals and lugs are essential in containing radio energy as well as safeguarding the user from any risk of electrical shock. The metal shell of the unit protects the internal circuitry from environmentally induced over stress conditions and is an integral part of the compliant system.



WARNING: Do not open the box or in any way expose the internal circuitry.



WARNING: There are no user-serviceable parts inside the unit. Opening or damaging the ZyPerUHD unit in any way voids the warranty and immediately nullifies any assertion of regulatory compliance made by ZeeVee. Any required service shall be performed by trained and qualified service personnel authorized by ZeeVee.



Cleaning

Encoder, Decoder and ZyPerMP Unit Cleaning Procedures

Before cleaning:



1. Switch off or fully disconnect the AC power from the external supply unit connector to the ZyPer unit.
2. If the state of the AC power cannot be established, disconnect the DC input plug from the ZyPer unit before proceeding.

Cleaning Procedure:

1. Any unused cable receptacles should be covered with the supplied rubber plugs or a piece of tape to prevent cleaner from entering and possibly affecting operation.
2. Clean the exterior of the unit with a soft cotton cloth that has been lightly moistened with an approved and recognized cleaning agent.

The exterior of the unit has been tested for compatibility with, and resistance to, the following products:

- ◆ Alcohol (Isopropyl and Ethyl)
- ◆ Ammonia-based cleaners (Windex)

In case none of the above cleaning products is available, water may be used.

Care should be taken to not spray cleaner directly on to the unit or into the vents to avoid liquid ingress and damage to the internal electronics.



CAUTION: Do not apply or spray liquid directly on to the unit's exterior as excess liquid may cause damage to internal electronics. Apply the liquid to the cleaning cloth first.

3. Repeat with water-moistened cloth only.
4. Wipe with a dry cloth
5. Air vents shall be checked to make sure that they are free of accumulated lint or blockages.

Should the air vents appear clogged use a vacuum cleaner with a soft-bristle brush attachment to loosen and draw the debris out of the vents and away from the unit.

Do not loosen and blow the debris in to the unit as internal buildup of debris will degrade the ability of the unit to cool itself and reliability may be adversely affected.

Do not apply power if there is any evidence of fluid in the interior of the unit.

ZyPerMP Specific Cleaning Procedure



The ZyPerMP control unit is not designed to be placed in an environment that would subject it to impurities that require as frequent cleaning as the encoder and decoder units. Should the ZyPerMP unit need cleaning, the same procedures apply as enumerated above, only a very sparing amount of cleaner should be applied to the cleaning cloth.

Important Siting and Application Considerations

ZyPerUHD60 Equipment Type and Uses

ZyPerUHD60 Intended Uses

- Equipment is intended for the distribution of Audio Visual Information in and around a facility.
- Equipment is intended to distribute Human Interface and control information over the same network as the Audio Visual information following the same or different logical distribution paths.
- Equipment does not generate video information itself, but accepts and distributes video information from industry-standard devices which generate such audio visual information.
- Equipment is intended for the sophisticated display and presentation of decoded information that has been distributed by companion ZyPerUHD equipment.
- Equipment is intended to be controlled from a central control node (the ZyPerMP) which ties in to a customer control system for sophisticated presentation and management of the information flow and direction.



WARNING: The installer should test and validate a complete setup with the actual devices before deploying to a final production installation.

Installation Environment

The general area where the ZyPerUHD60 unit is to be installed shall be clean and free of obstructions or clutter.

Mounting Options

- Unit may be mounted horizontally
- Unit may be bolted to a horizontal surface using the provided L-brackets
- Unit may be mounted vertically only if appropriate clearance is provided around the grille work for adequate airflow. The appropriate ZyPerUHD60 rack mount kits insure that airflow space is sufficient when mounting vertically.
- Units may be stacked in a horizontal orientation providing stack is no higher than 3 units
- In all cases, insure that the units are rigidly held in place and will not be subject to impact and there is no possibility of toppling.
- Do not stack any other equipment or devices on top of the unit weighing more than 3Kg and only if sufficient bracing is provided to protect against toppling.



WARNING: Failure to adhere to these recommendation could result in unsafe operation, damage to the equipment, or injury to the operators.

Ventilation

Ambient environmental temperature and humidity shall not exceed that specified in the Detailed Specifications portion of this document.

Ambient temperature in this case refers to the temperature of air entering the device through the ventilation grille. Care should be taken to not enclose the device or deploy in a fashion where airflow loops or local “hot spots” can cause the inlet air to rise above the specified limit for normal operation.

In general 25mm (\approx 1inch) of clearance should be provided around the ventilation openings unless an external air mover insures that the inlet temperature is at or below the specified limit.

If the equipment is mounted in an enclosed cabinet, it is the job of the installer to insure that within the cabinet or enclosure the ZyPerUHD60 equipment does not experience local temperatures in excess of that specified in the Detailed Specifications portion of this document.

Water and moisture

Never expose the ZyPerUHD60 unit to direct rain, moisture, or excessively high humidity.

Never use the device near water - e.g. near a bathtub, basin, pool, sink, or in a wet basement.

Clean only in accordance with the instructions in this manual.

AC Mains Connection

The ZyPerUHD60 Encoder and Decoder units are powered through an external AC/DC converter unit or via the Ethernet PoE feature.

If PoE is not available, the Encoder and Decoder units must be powered and connected using an external AC/DC converter. (Available separately) The voltage supplied to the Triple Input Encoder units from the external supply is 20VDC at 6.0A. All other Encoder and Decoder units, power from external supply is 12VDC at less than 2.0A.

- Do not substitute the supplied AC/DC power supply unit with another component. The overall system compliance is dependent on each of the provided elements being present and operational.



INFORMATION: The introduction of a foreign, non-ZeeVee element nullifies any claim of regulatory compliance asserted by ZeeVee.

The AC/DC power supply shall be powered from the appropriately rated AC mains voltage which allows for a wide range of input, generally from 100VAC through 240VAC.

Only use a power cord with an appropriately rated protective earth connection. The protective earth connection is essential to the overall safety of the system.



WARNING: Bypassing or omitting the protective earth connection increases the risk of electrical shock and radio emissions



Install the equipment in such a manner as the IEC power cord ingress in to the AC/DC adapter is accessible as this is the boundary of the AC mains system and the point at which the ZyPerUHD60 equipment is disconnected from the AC mains power if needed.

The equipment should be installed as near as is practicable to an AC outlet.

- Do not substitute or extend the DC cable from the AC/DC unit.

The ZyPerUHD60 system is intended and rated for continuous operation

Should the ZyPerUHD60 equipment be unused for an extended period of time it should be disconnected from the AC mains at the AC inlet to the external AC/DC converter in order to protect the equipment from transient over-voltage conditions.

AC Power Cord

Connect the external AC/DC supply unit to the AC mains with a UL-listed detachable power cord, 3-wire, type SJ or equivalent, 18 AWG min., rated 250 V min., plug 5-15P configuration for 120V application, or 6-15P for 240V application.

AC/DC converter inlet side of AC cord shall be of type IEC320C13



- Do not overload wall outlets and extension cords.

Power cords should be routed so that they are not likely to be walked upon or pinched by items placed upon or compressing them.

Match the rating of the power cord to the voltage of the power outlet in accordance with the specific requirements and in compliance with safety standard of your particular country.

Responsibility and Stewardship

ZeeVee is committed to using the planet's resources efficiently and having as little negative impact on the environment and health of mankind as possible.

Our products consume very little energy and attempt to provide the highest level of function for the smallest investment in resources.

Reduction of Hazardous Substances (RoHS)

RoHS Directive 2011/65/EC, Directive 2002/95/EC, Directive 2003/11/EC

Product Lines:

ZyPer Products supplied by ZeeVee, Inc.

Be advised that based on the information available to ZeeVee from our component and sub-assembly providers, the product lines listed above do not contain as intentional additives, any of the referenced materials at the levels indicated, as referenced in the subject EU directives. To the best of our knowledge, none of these materials are generated during production and the supplied component parts of the ZeeVee products do not contain the listed materials. Since we do not expect these materials to be present, we do not specifically run a complete analysis on all finished goods, excepting for periodically auditing the finished goods and component materials in certain circumstances.

This information is believed to be accurate and refers to the laws, regulations and products at the date of issue. However, ZeeVee makes no express or implied representations or warranties with respect to the information contained herein. It is the responsibility of our customers to determine that their use of ZeeVee products is safe, lawful, and technically suitable for their applications. Because of possible changes in the laws and regulations, we cannot guarantee that the status of the listed products will remain unchanged.

Waste Electrical and Electronic Equipment

WEEE Directive 2012/19/EU on waste electrical and electronic equipment

The WEEE Directives (2008/98/EC and 2012/19/EU) place an obligation on electrical equipment manufacturers and importers to recycle electronic products at the end of their useful life.

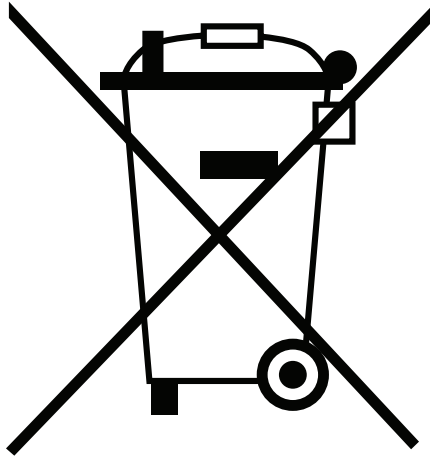

ZeeVee products that are marked with the WEEE symbol (see left) indicate that the product must NOT be disposed of with other household waste. Instead, it is the user's responsibility to dispose of their waste electrical and electronic equipment by handing it over to an approved re-processor or by returning it to an authorized agent of ZeeVee or their distributor for recycling. To prevent possible harm to the environment or human health from uncontrolled waste disposal, please separate these items from other types of waste and recycle them responsibly.

For more information about the recycling of this product, please contact your local waste disposal authorities or local municipal waste disposal service.

For specific questions related to WEEE compliance of ZeeVee products contact: support@zeevee.com

This information is believed to be accurate and refers to the laws, regulations and products at the date of issue. However, ZeeVee makes no express or implied representations or warranties with respect to the information contained herein. It is the responsibility of our customers to determine that their use of ZeeVee products is safe, lawful, and technically suitable for their applications. Because of possible changes in the laws and regulations, we cannot guarantee that the status of the listed products will remain unchanged.

ZeeVee, Inc.
295 Foster Street, Littleton, MA 01460

FCC Compliance Statement

The ZyPerUHD family of devices has been tested and found to comply with the limits for Class A Digital Devices pursuant to Part 15 of the FCC Rules. Operation is subject to the following conditions: 1) these devices may not cause harmful interference, and 2) these devices must accept any interference received including interference that may cause undesired operation.

This equipment generates, uses, and can radiate radio frequency energy and, if not installed or used in accordance with the instructions, may cause harmful interference to radio communications. However there is no guarantee that interference will not occur in a particular installation.

If this equipment does cause harmful interference to radio or television reception, which can be determined by turning the equipment off and on, the user is encouraged to try to correct the interference by one or more of the following measures:

1. reorient or relocate the receiving antenna
2. increase the separation between the equipment and the receiver
3. connect the equipment to an outlet on a circuit different from that to which the receiver is connected
4. consult the dealer or an experienced radio/TV technician for help.

Any changes or modifications not expressly approved by the party responsible for compliance could void the user's authority to operate the equipment. Where shielded interface cables have been provided with the product or specified additional components or accessories elsewhere defined to be used with the installation of the product, they must be used in order to ensure compliance with FCC regulations.



In order to insure compliance with the referenced FCC regulations, only deploy the equipment with provided or approved accessories in the manner indicated in this and other pertinent manuals.

Use only approved and properly shielded cables of good quality.

Address any inquiries to:

ZeeVee, Inc.
295 Foster Street, Suite 200
Littleton, MA 01462

EMC Information

The ZyPerUHD devices should be mounted and operated in accordance with the guidelines specified in this guide to maintain the integrity of the expected EMC characteristics.

The supplied Power Supply (AC/DC Conversion unit) should be used. Any other AC/DC supply has not been tested or verified to perform at the levels indicated in this manual.

Media cables are not provided and the ZyPerUHD devices are generally fairly tolerant of different types and manufacture styles.

- Media cables should be of good quality and rated for the performance levels of the interface to which they are connected.
 - e.g. 4K HDMI ports should only be connected to HDMI cables rated for 4K operation at the desired resolutions.
- HDMI cables shall be of the type incorporating integral Ferrite cores in order to achieve rated compliance levels and the cleanest electromagnetic environment in the vicinity of the unit.

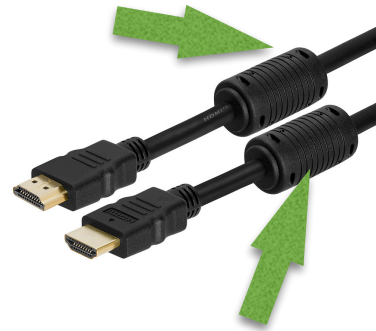

Electromagnetic Emissions

Test	Compliance Level	Notes
RF emissions: CISPR 11	Group 1	ZyPerUHD emissions are very low and not expected to cause unintentional interference.
RF emissions: CISPR 11	Class A	Commercial equipment for use in commercial environments.
Harmonic emissions: IEC 61000-3-2	Class D	Suitable for use in all commercial and domestic low-voltage environments.
Voltage fluctuations/ flicker emissions: IEC 61000-3-3	Compliant	

Appendix 1

Known Good USB-C Cables

The following USB-C cables have been tested with the ZyPerUHD60 units for simultaneous support of the following features: 3840 x 2160 video at 60Hz. Audio. USB Data for Webcam video transfer. 60W power charging. (External power supply to ZyPerUHD60 required)

Manufacturer / Part Number	Length	Link
BTX BTX-USB4G3CMM1M	1.0m	https://www.btx.com/usb4-g3x2-usb-c-m-m-40g-5a-240w-1m
BTX BTX-USB4CMM2M	2.0m	https://www.btx.com/usb-4-0-gen-2x2-20-gbps-240w-2-meters
Comprehensive USB10G-CC-3PROBLK	3 ft	https://comprehensiveco.com/products/pro-av-it-integrator-series-certified-ultra-flexible-10g-usb-c-to-c-male-4k-av-and-data-cable-3ft.html
Comprehensive USB10G-CC-6PROBLK	6 ft	https://comprehensiveco.com/products/pro-av-it-integrator-series-certified-ultra-flexible-10g-usb-c-to-c-male-4k-av-and-data-cable-6ft.html
Comprehensive USB10G-CC-10PROBLKA	10 ft	https://comprehensiveco.com/products/pro-av-it-integrator-series-certified-ultra-flexible-10g-usb-c-to-c-male-4k-av-and-data-cable-10ft.html
Comprehensive USB10G-CC-15PROBLKA	15 ft	https://comprehensiveco.com/products/pro-av-it-integrator-series-certified-ultra-flexible-10g-usb-c-to-usb-c-male-4k-av-and-data-cable-15ft.html
Cables to Go C2G28885 C2G28886 C2G28887	0.5m 0.8m 2.0m	https://www.cablestogo.com/usb-and-pc/usb-c-cables-adapters-and-hubs/thunderbolt-cables/6ft-2m-thunderbolt-4-usb-c-active-cable-40gbps/p/cg-c2g28887?text=28887
iVANKY VBD10	1.0m	https://www.amazon.com/Thunderbolt-Compatible-Tablets-Samsung-More-3-3ft/dp/B088627SLY?th=1
Lindy No. 43348	3.0m	https://www.lindy.co.uk/cables-adapters-c1/usb-c449/3m-usb-3-2-gen-2-c-c-active-cable-p14214
Lindy No. 43308	5.0m	https://www.lindy.co.uk/cables-adapters-c1/usb-c449/5m-usb-3-2-gen-2-c-c-active-cable-p13340
Plugable TBT3-40G80CM	0.8m	https://www.amazon.com/dp/B07R43LPCX?ref=ppx_yo2ov_dt_b_product_details&th=1

Appendix 2

USB-C Charging

The ZyPerUHD60 Encoders with USB-C input are capable of charging devices over the attached USB-C cable if the external 20V power supply is connected to the ZyPerUHD60 Encoder.

Charging level is controlled by the attached device such as a MacBook. This ensures that the ZyPerUHD60 is not providing more power to the connected device than is called for.

Examples:

MacBook (2016) Power supplied while “charging” = Approximately 24-25W
 Power supplied while fully charged in sleep mode: Less than 1W

MacBook Pro (2018) Power supplied while “charging” = Approximately 52W
 Power supplied while fully charged in sleep mode: Less than 1W

How seen by MacBook or MacBook Pro:

AC Charger Information:

Connected:	Yes
ID:	0x0000
Wattage (W):	60
Family:	0xe000400a
Charging:	Yes

Important note: The USB-C cable must be capable of carrying the required current. Low quality cables present a danger of possible cable fire. See Appendix 1 for recommended cables.

USB-C Cable Requirements

1. Cable should be as short as possible
2. Must have USB-IF certification
3. Must be USB 3.2 Gen2 (2x1 or 2x2)
4. Current rating of 3A or 5A
5. Must support USB power delivery of 60W 20V/3A or 100W, 20V/5A
6. Video Data specs must be 10Gbps per lane (4K@60Hz) or above. (20Gbps cable)
7. USB Data specs must be 5Gbps (USB 3.0)
8. Must have built in E-Mark IC

ZeeVee is not responsible for damage to any equipment caused by poor or incorrect USB-C cables.

Appendix 3

PoE Power and PoE Switches

It is important to remember that the ZyPerUHD60 is a device that requires a 1Gb network. Therefore any PoE injector must also support 1Gb data transfer.

To support PoE the following **minimum** Ethernet cable requirements must be met.

- Must be Cat5e 24AWG Solid Copper Twisted Pair.
- Cat6a is strongly recommended.
- **Must be shielded**
- Maximum Length 328ft (100m)
- DC Loop Resistance per Pair < 25Ω
- DC Resistance Unbalance per Pair 3% or < 200mΩ

Recommended Cables:

ZeeVee has validated and can recommend Ethernet cables from Siemon Cable.

North America Link:

<https://ecatalog.siemon.com/en/Copper/Cable/Category-6A-Shielded-Cable-North-America>

International Link:

<https://ecatalog.siemon.com/en/Copper/Cable/Category-6A-Shielded-Cable-International>

Important Note

If using a Network Switch to provide PoE power to the ZyPerUHD60 devices, it is important that the switch itself be protected against electrical surges that could be caused by something like a lightning strike. An appropriate surge protector should be placed between the Network Switch and AC power source.

Why Shielded Ethernet Cable Is Required

Shielded cable must be used with PoE systems to provide the ZyPerUHD60 endpoint a path to ground when another path is not available. Shielded cable options include: F/UTP, S/UTP, F/FTP, S/FTP, SF/UTP and SF/FTP.

Unshielded Example:

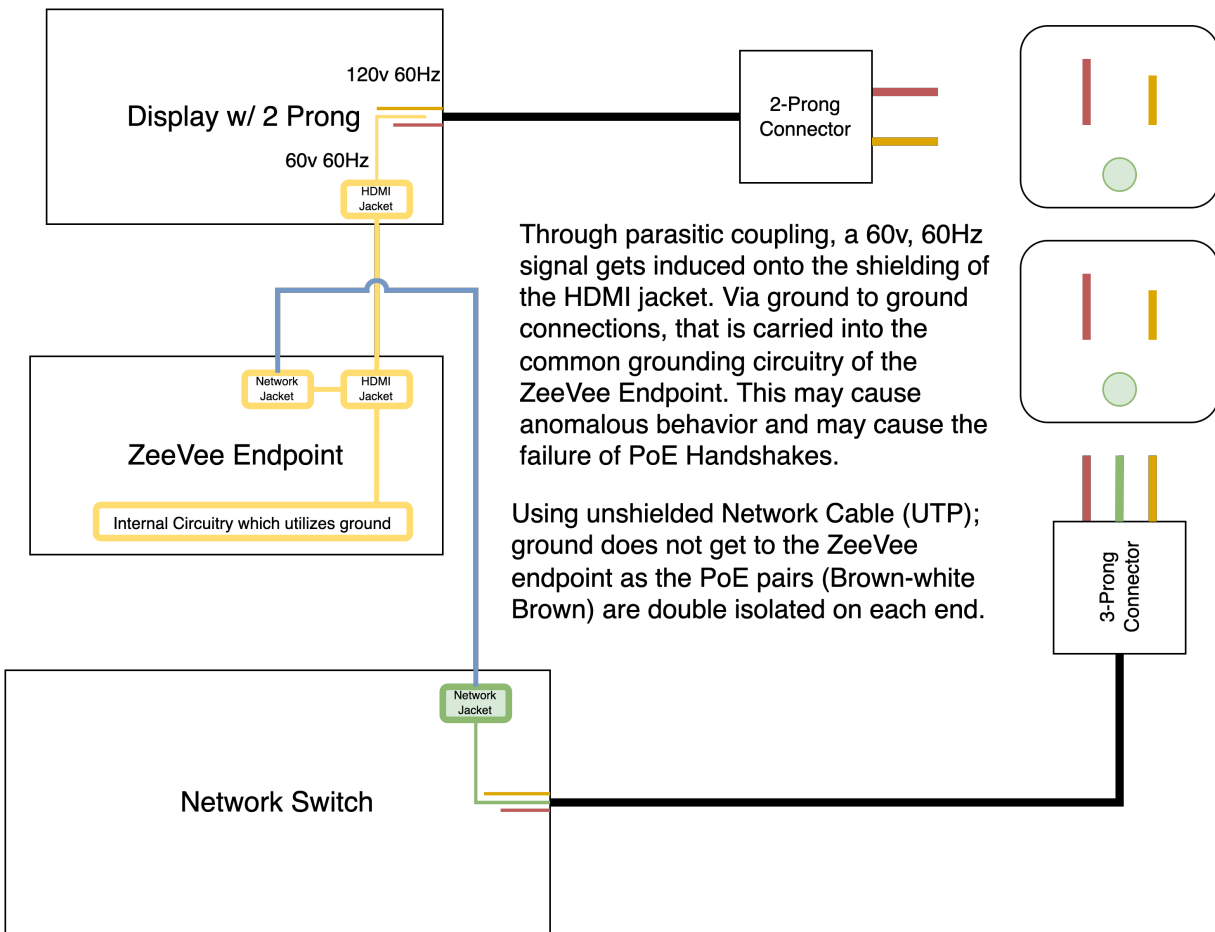

Shielded Example (F/UTP, S/UTP, F/FTP, S/FTP, SF/UTP or SF/FTP)

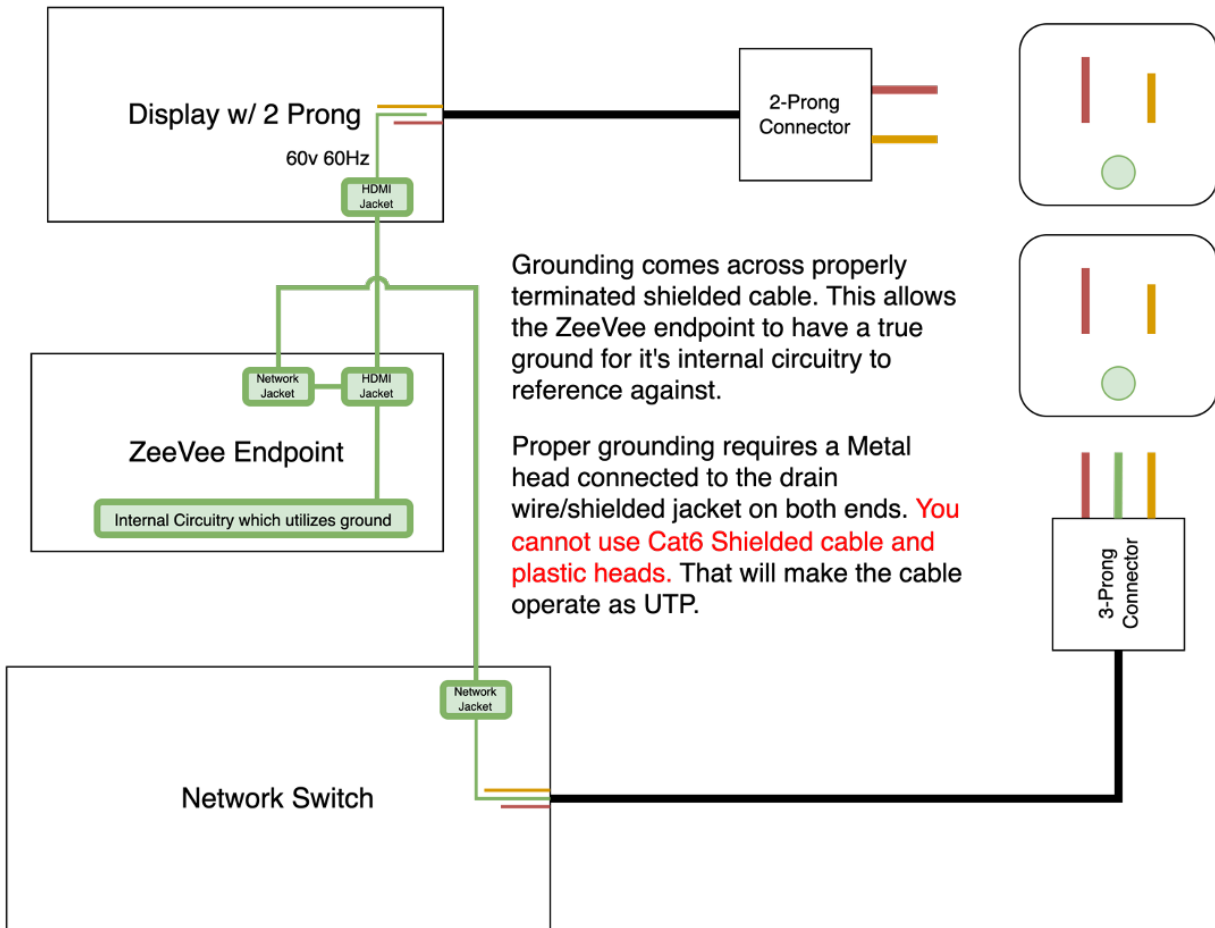

Appendix 4

Dual LAN Connection Options (Non-Dante UHD60 units)

The following are examples of how the secondary or utility LAN port can be used with a ZyPerUHD60 encoder or decoder. Please note these examples are for the Non-Dante enabled UHD60 units.

Green connections are valid. Red connections are not valid.

Computer/Laptop

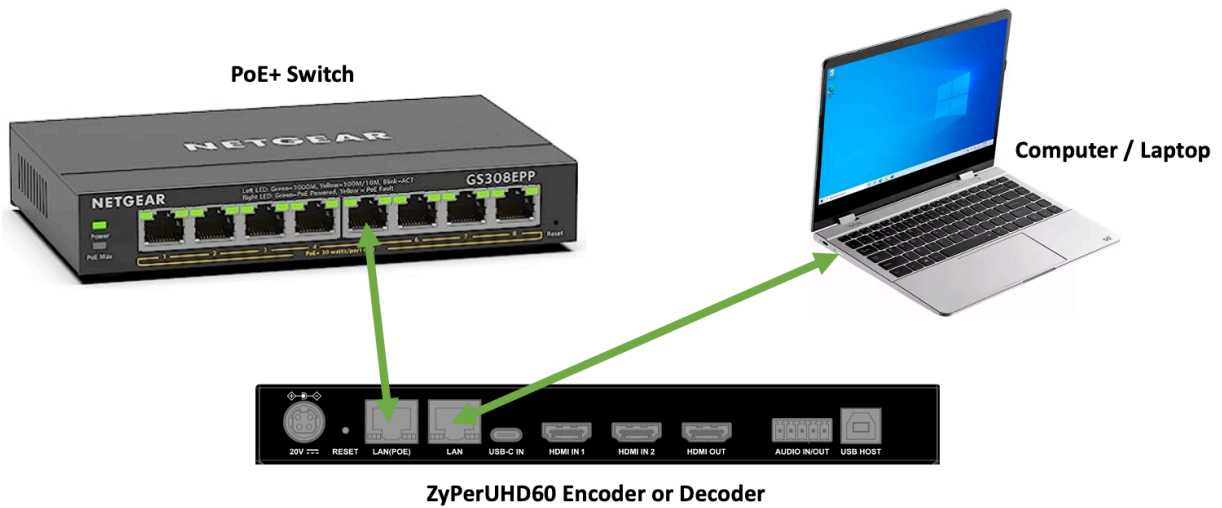

Display/Monitor

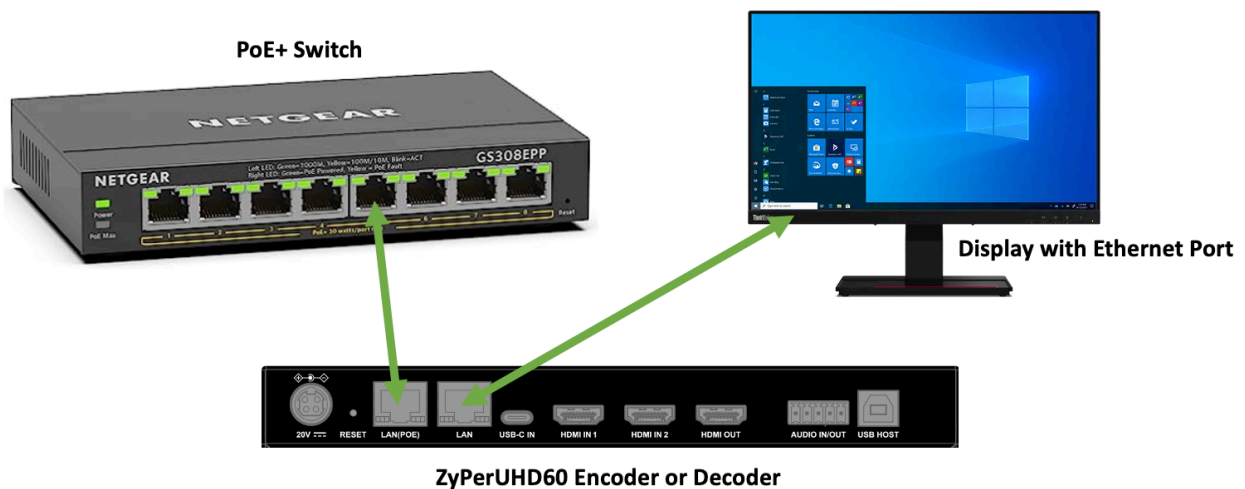

Dante Devices (Speaker, Microphone etc..)

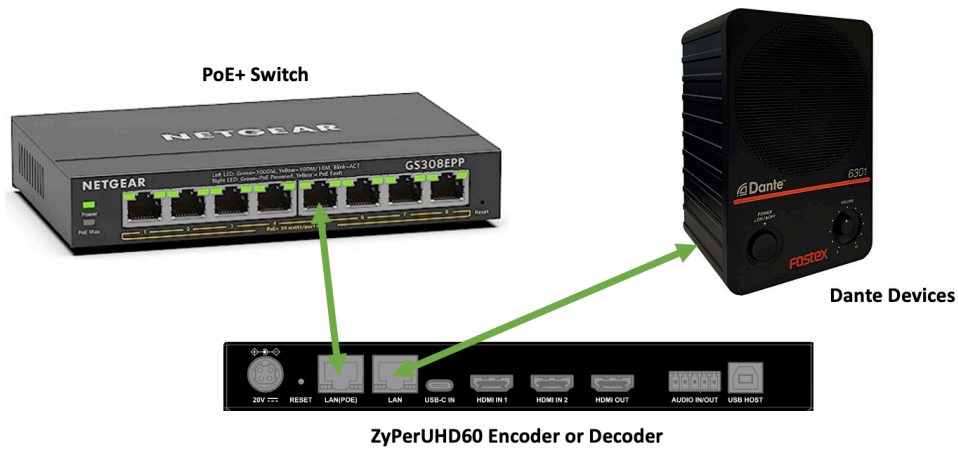

Other ZyPerUHD60 Endpoints (Not allowed)

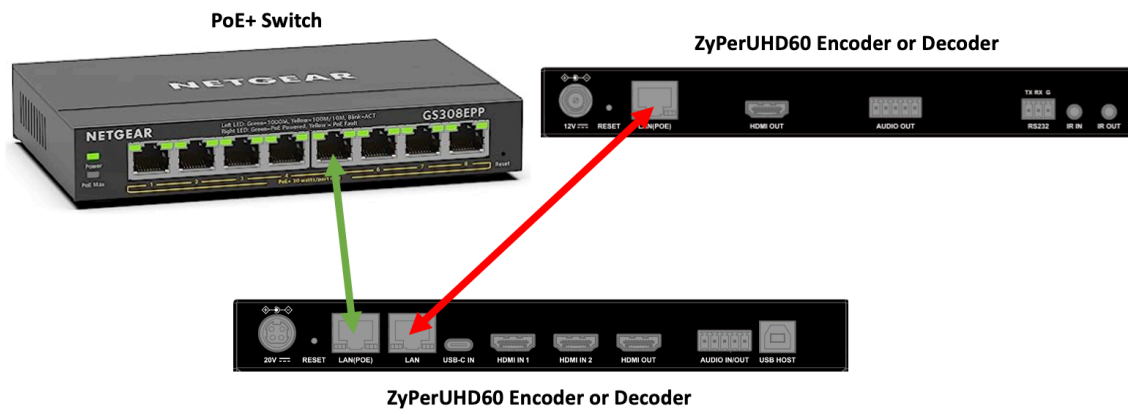

Back to the same LAN (Not allowed)

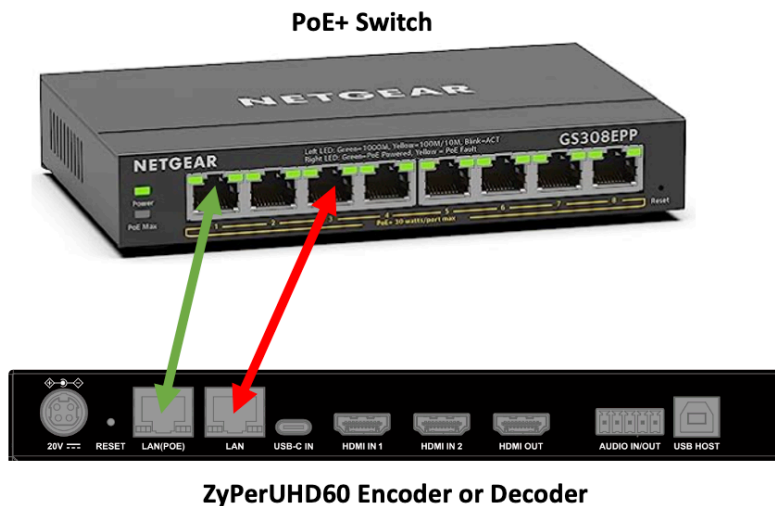

Appendix 5

Accessories

Part Number	Description
ZUHD60RACK	ZyPerUHD60 6RU Rack mount. Holds up to 10 ZyPerUHD60 encoders/decoders. Includes 4 blank panels.
ZUHD60BP	ZyPerUHD60 Spare blank panel for ZUHD60RACK.
12V2APS	ZyPerUHD60 12 Volt Power Supply is a 12 Volt, 2A Power Supply for UHD60 units. Includes US, UK, EU and AU adapters. (Not compatible with 2E, 2EA, 2EMP and 1WE encoders)
20V6APS	ZyPerUHD60 20 Volt Power Supply is a 20 Volt, 6A Power Supply for UHD60 Encoder units. (Only compatible with 2E, 2EA and 2EMP units)
U60WPPS	ZyPerUHD60 20V 6A power supply with 2-pin phoenix connector for UHD60 Wallplate, with US power cable. (Only compatible with Wallplate Encoder)
U60WP-Black	Black decora face plate and black panels for ZUHD60-1WE. Note this is a spare set of black plastic panels. Both black and white sets ship in the box with UHD60 Wallplate Encoder. Spare set does not have ZeeVee silkscreen.
ZYPERPAD	ZyPerPad is a 10-button IP enabled keypad controller which provides a simple means of sending commands to the ZyPer Management Platform (ZMP). With built-in PoE, it can receive power from a PoE enabled ethernet switch. It supports individual button configuration via a simple to use web user interface.

Disclaimers

ZeeVee has striven to ensure that this document is accurate and represents the described products fully. Although, ZeeVee assumes no responsibility for errors found, should any be found, please contact support@zeevee.com and corrections will be issued as appropriate.

ZeeVee hardware designs are property of ZeeVee.

Components, sub-assemblies, and methods utilized in the designs are free of any encumbrances or appropriate licenses and rights have been obtained by ZeeVee for the use in the described products in the intended manner.

ZeeVee software is the sole property of ZeeVee except within the restrictions and guidelines of any open-source or public-license component utilized. ZeeVee represents that normal usage of the product in a typical customer installation is fully within the granted rights and privileges of any licensed component. Visit www.zeevee.com for further details.

The specifications of the described products may change at any time without notice.

ZeeVee forbids unauthorized disassembly, reverse-engineering, duplication, or any other attempt to recreate all or portions of the hardware or software outside of any use explicitly authorized in writing by ZeeVee.

Trademarks

All trademarks are the property of their respective owners.

Copyright

This document is copyrighted with all rights reserved. This document or any portion contained may not be reproduced or copied by any means - graphically, mechanically, or electronically - without express written authorization of ZeeVee.

© 2022 ZeeVee, Inc. All rights reserved.