

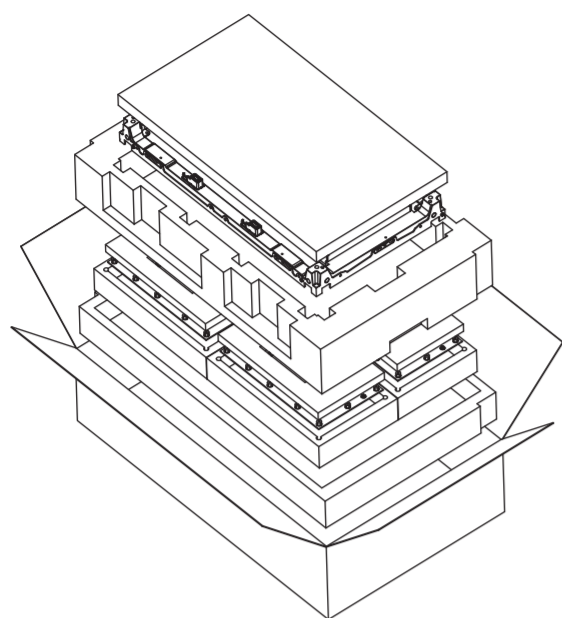

Contents



LAN cable
(RJ45, CAT-5)



Power cable
(daisy chain)



Quick start guide

* Differences according to regions.
Display design and accessories may differ from those illustrated above.



Not included:



1 Unpacking



Notes:

1. After unpacking, ensure that the modules are in good condition. If anything is damaged or broken, please contact your local service center immediately.
2. Use a pair of scissors to cut vacuum packaging, then take the modules out of the package. Be extremely careful not to damage the module when using the scissors.
3. It is required to wear anti-static gloves before handling the cabinet.
4. Do not place the display vertically on the floor, as it may fall down and get damaged. (The damage will not be covered by warranty)

Rear/top/side/bottom views

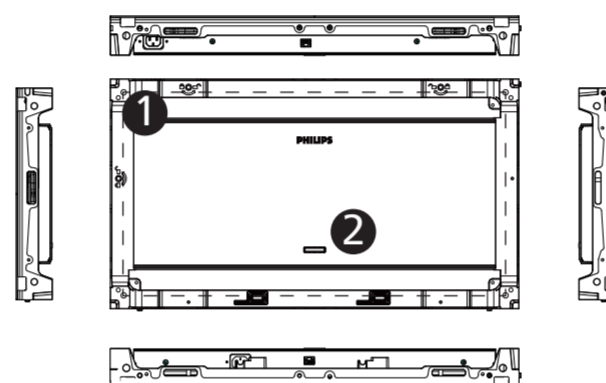

- 1 Mounting holes for screw bolt
- 2 CHECK button

2 Connections

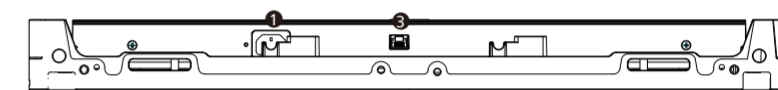
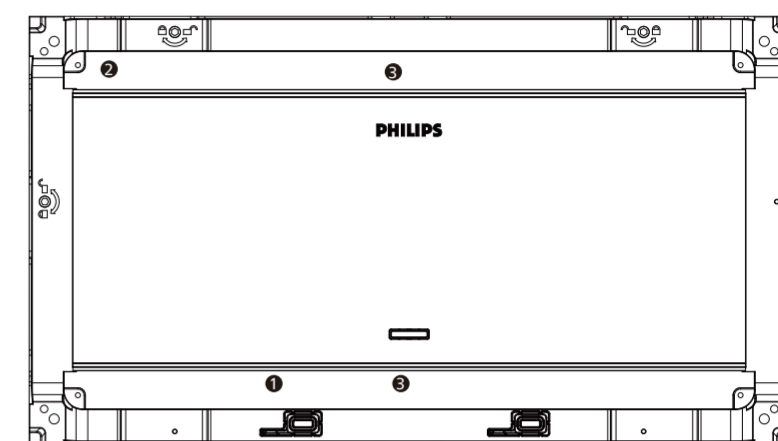
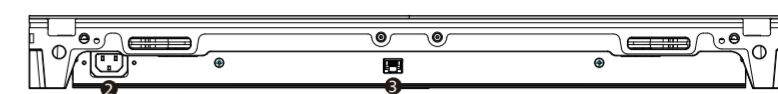

- 1 POWER IN connector
- 2 POWER OUT connector
- 3 DATA connector

3 Mounting the LED panels/cabinets

a

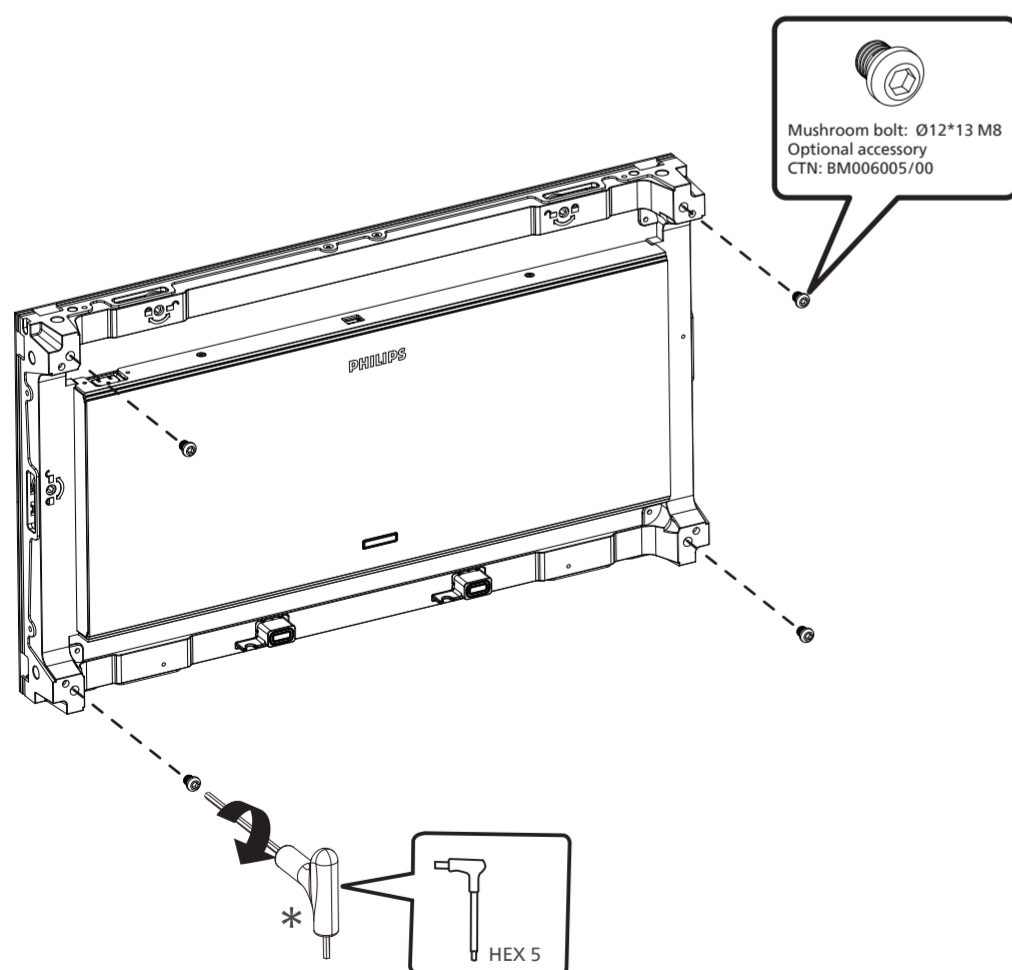

Mushroom bolt: Ø12*13 M8
Optional accessory
CTN: BM006005/00

HEX 5

* Not included

b

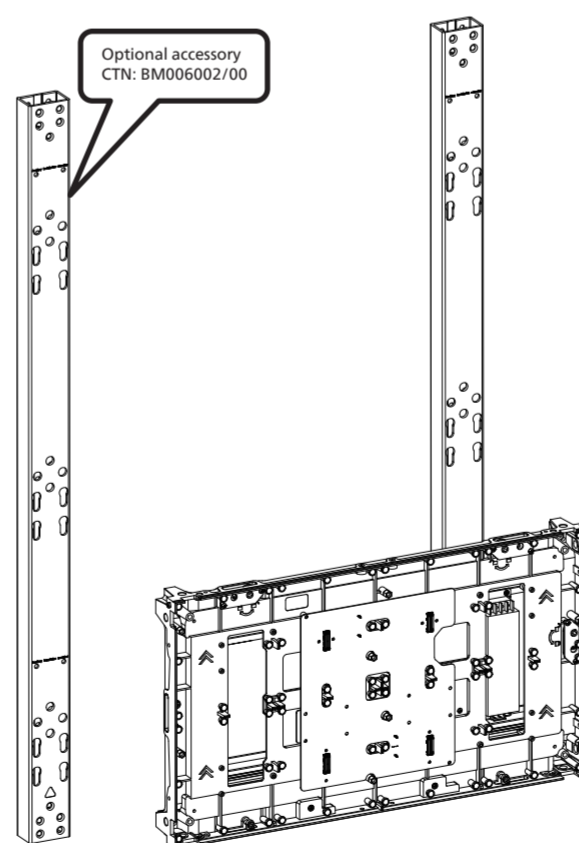

Optional accessory
CTN: BM006002/00

c

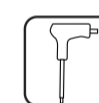
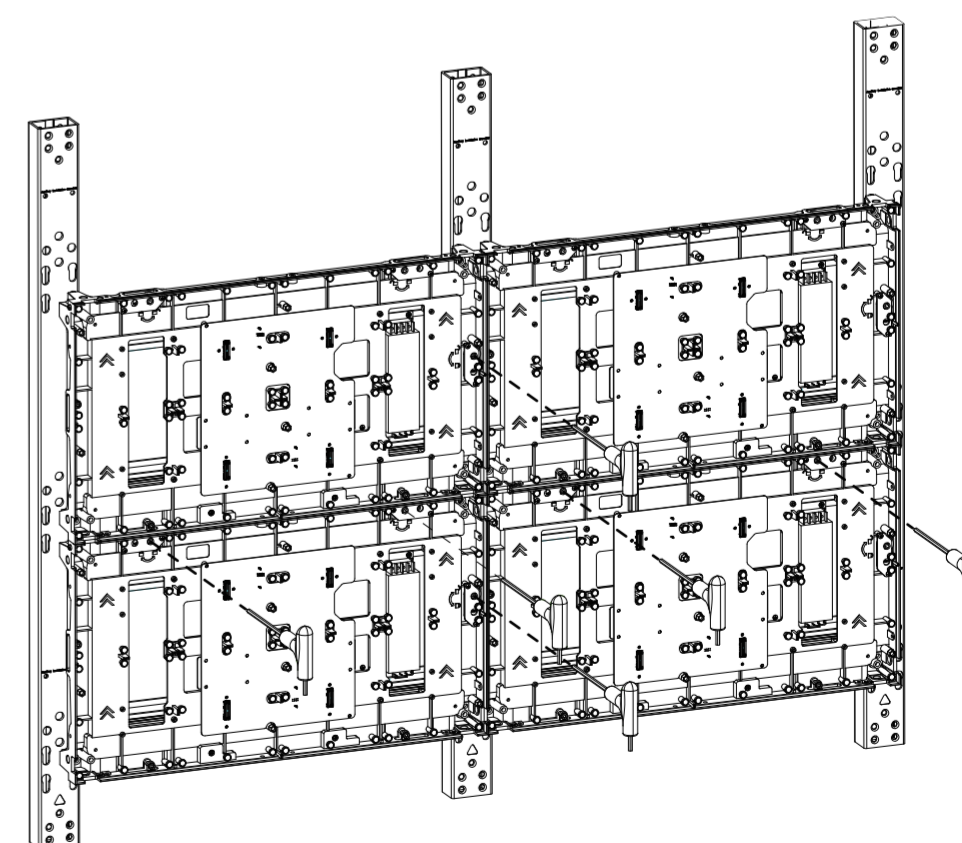

4 Connecting the data and power cables

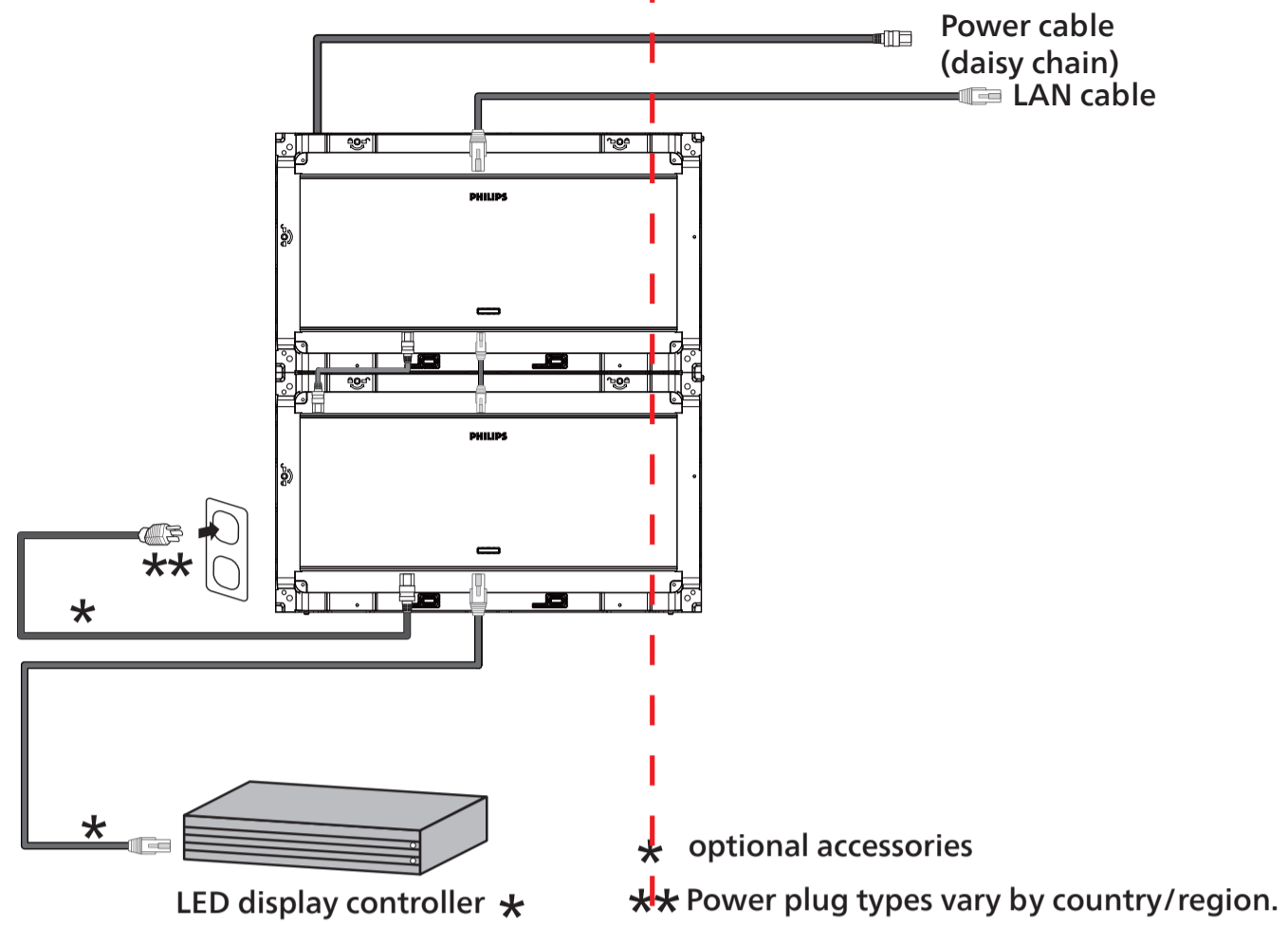
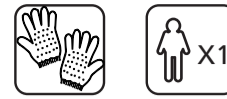

⚠ Plug the power plug into the electric outlet only when the cables are properly wired.

Note: More cable wiring scheme and mounting scheme can be found in the User's Manual.

PHILIPS

Professional Display Solutions

L Line

27BDL61xxL

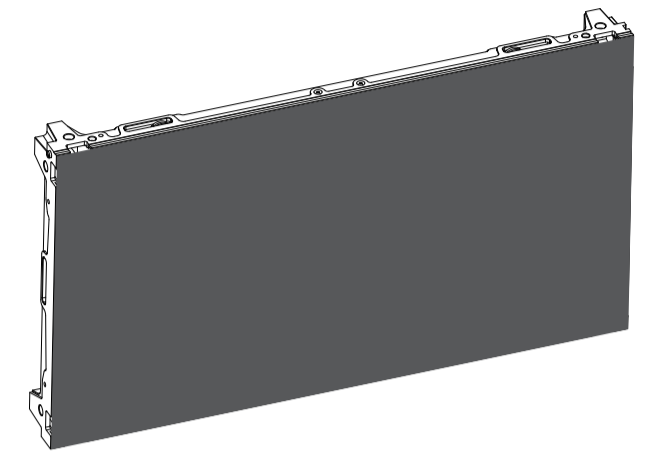

Quick start



For more information, please visit:
https://www.philips.co.uk/p-m-pr/signage-solutions/latest#filters=L_LINE_SERIES_SU

5 Installing the LED modules

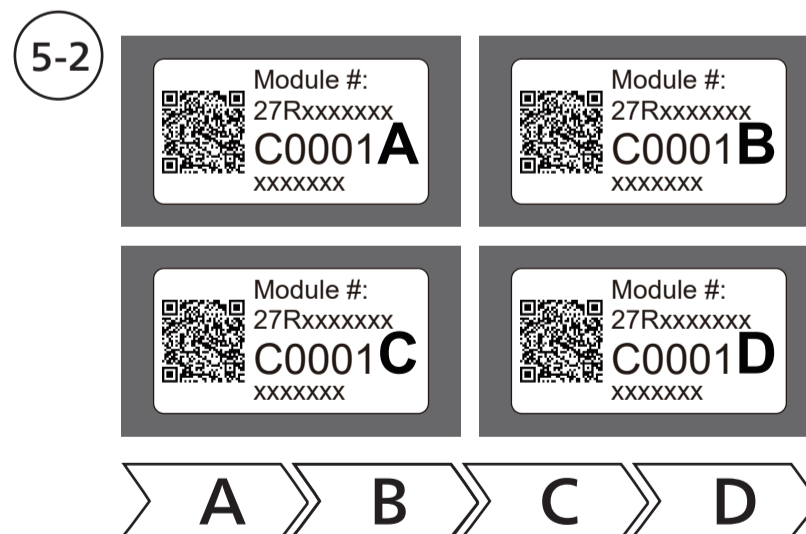
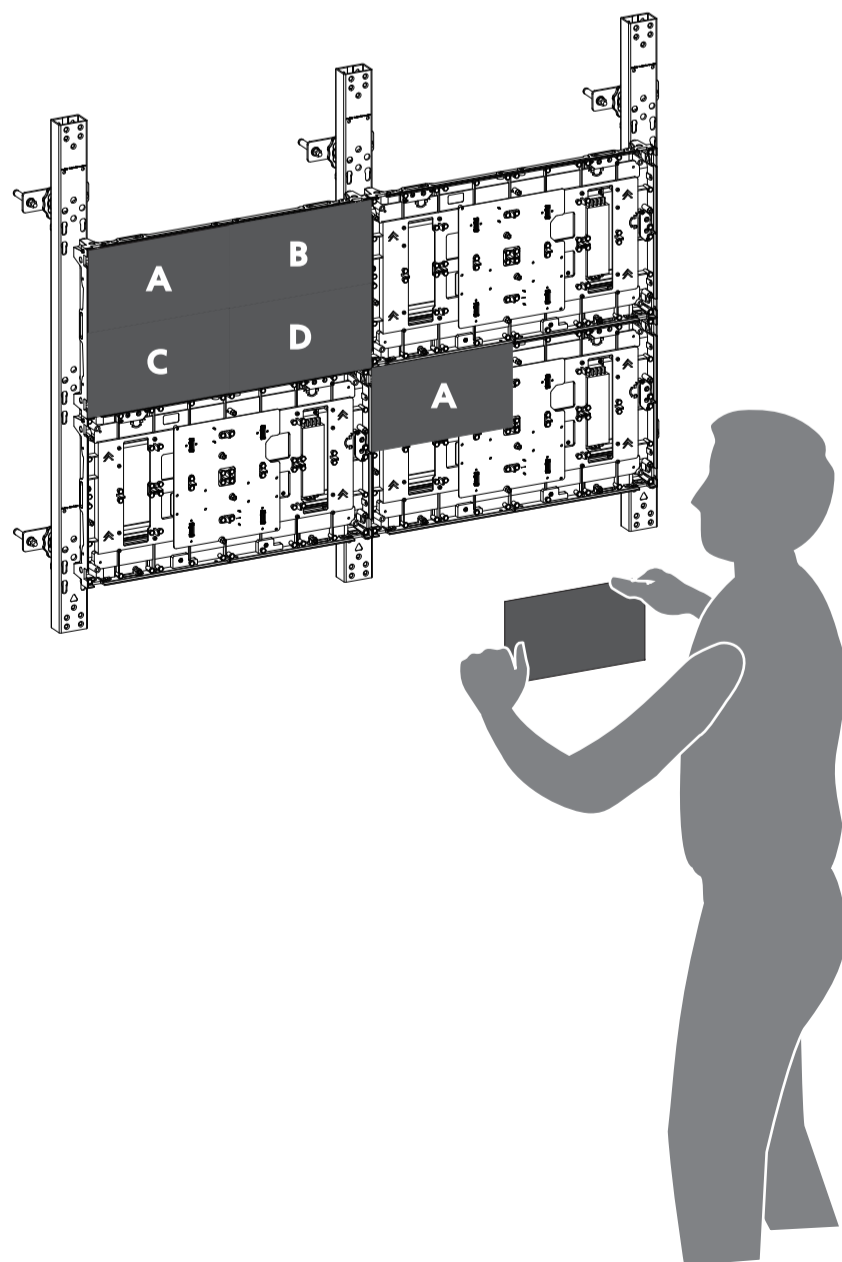
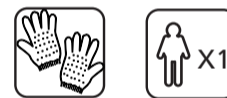

Version: V1.01 2022-02-26

MMD-Monitors & Displays Nederland B.V.
 Prins Bernhardplein 200,
 1097 JB Amsterdam,
 the Netherlands

2022 © TOP Victory Investments Ltd. All rights reserved.

This product has been manufactured by and is sold under the responsibility of Top Victory Investments Ltd., and Top Victory Investments Ltd. is the warrantor in relation to this product. Philips and the Philips Shield Emblem are registered trademarks of Koninklijke Philips N.V. and are used under license.

Specifications are subject to change without notice.

UK Authorized Representative
 UKCA Experts Ltd.
 Dept 302, 43 Owston Road Carcroft
 Doncaster, DN6 8DA United Kingdom

Envision Peripherals Inc.
 490 N McCarthy Blvd, Suite #120
 Milpitas, CA 95035
 USA

