

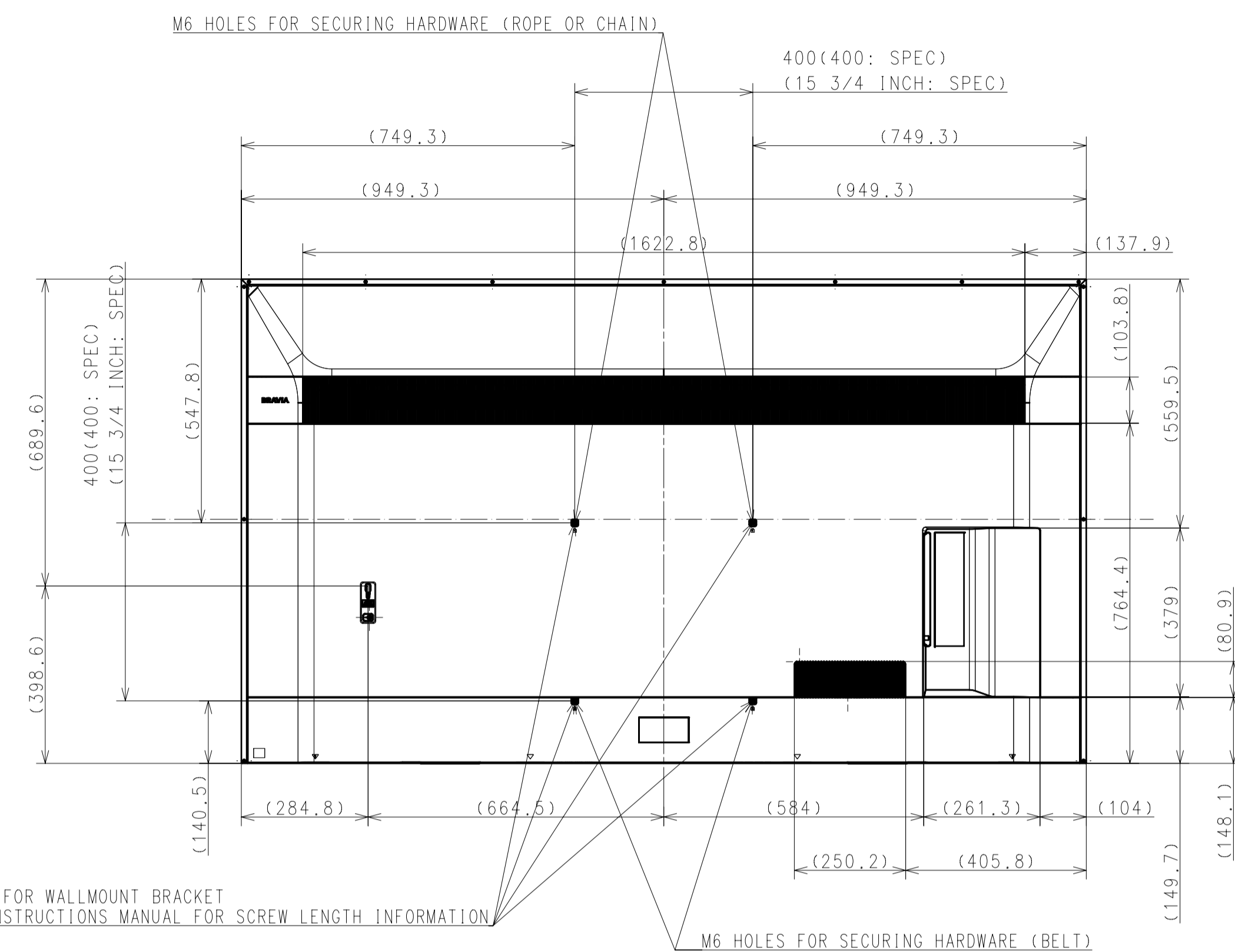

WITHOUT STAND

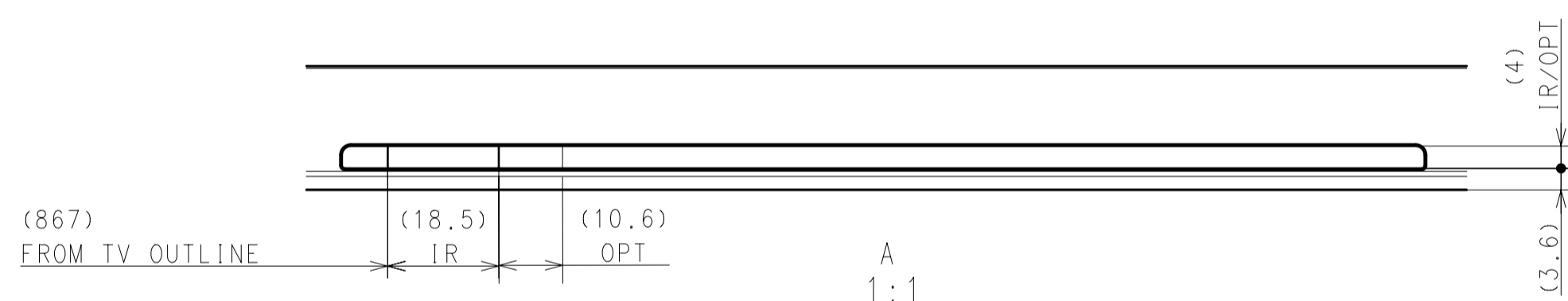

For NORTH AMERICA, EUROPE, GENERAL AREA, CHINA

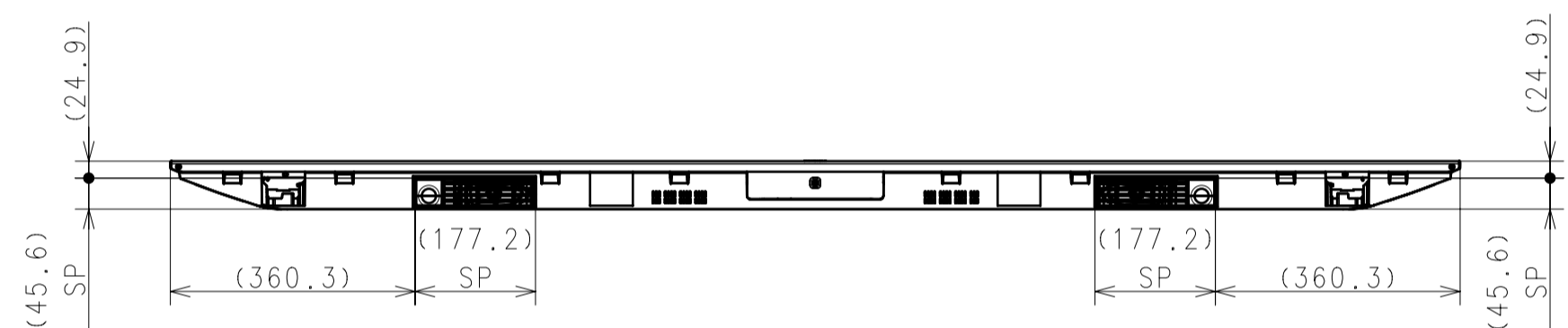
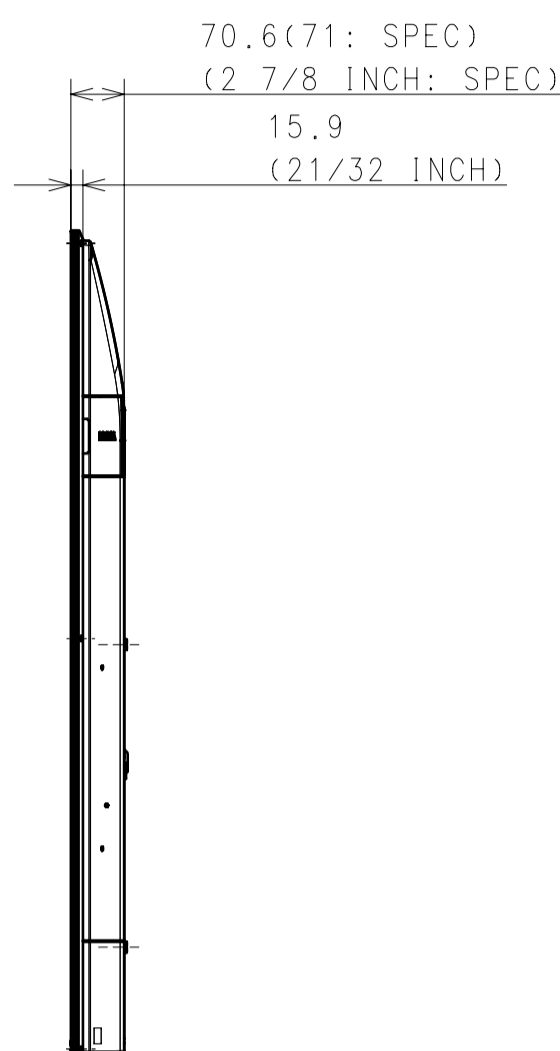
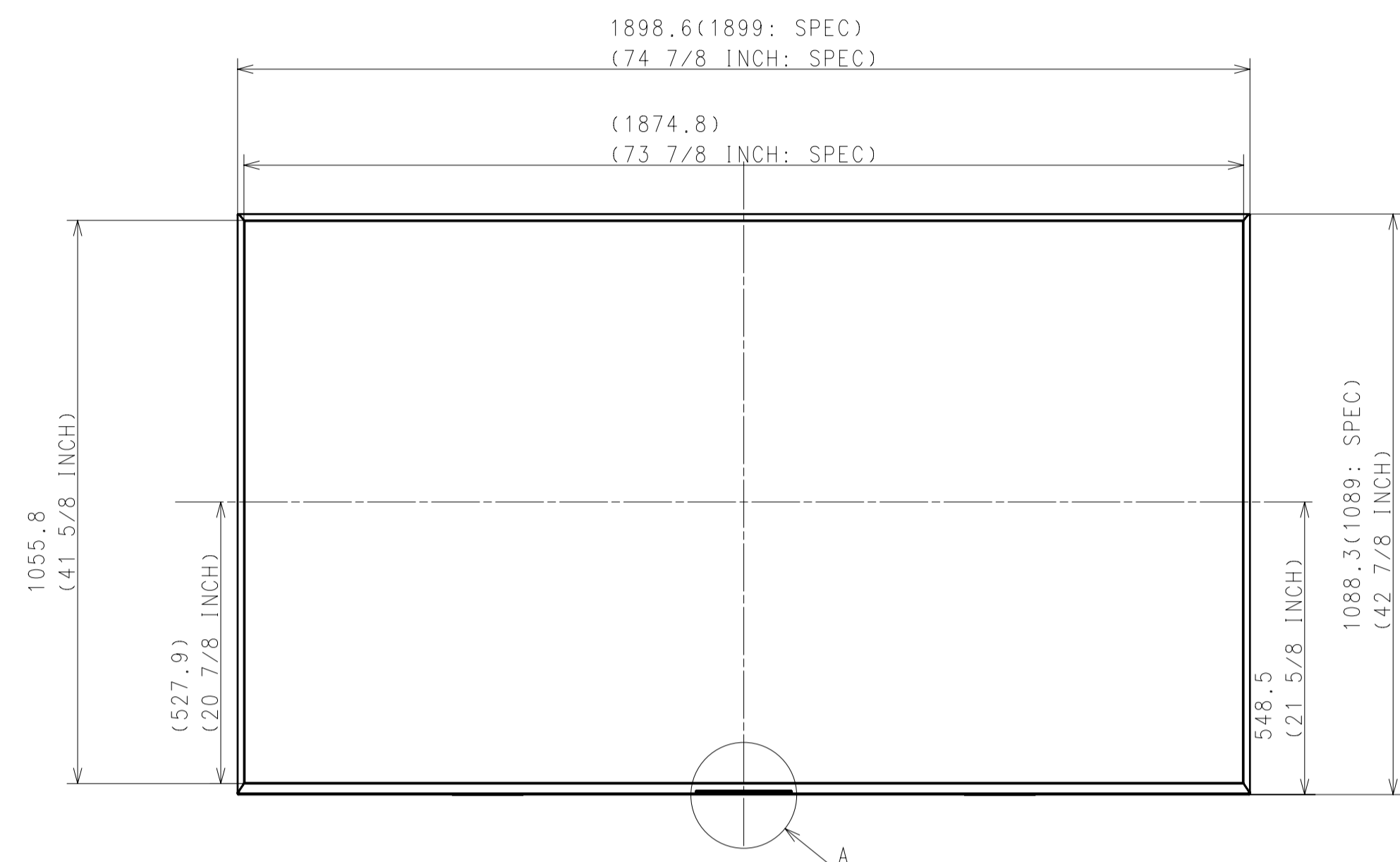
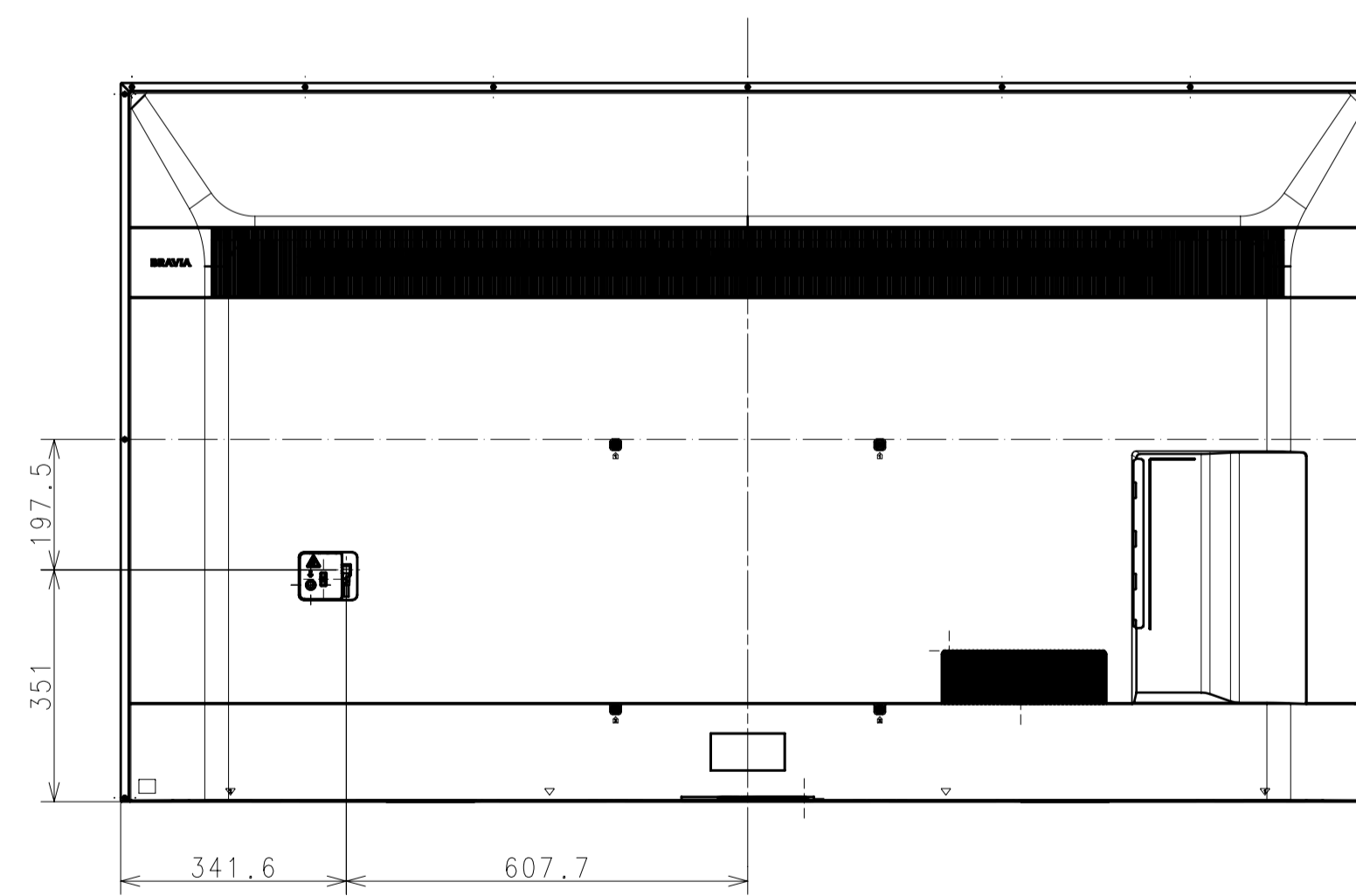

For JAPAN

DESCRIPTION	SCALE
85(BZ40L) EXTERIOR VIEW	1:1
LEGAL OWNER	SHEET/PAGES
Sony Corporation	2 / 3
PART NO.	
85(BZ40L) EXTERIOR VIEW	

SU\_WL450 SLIM

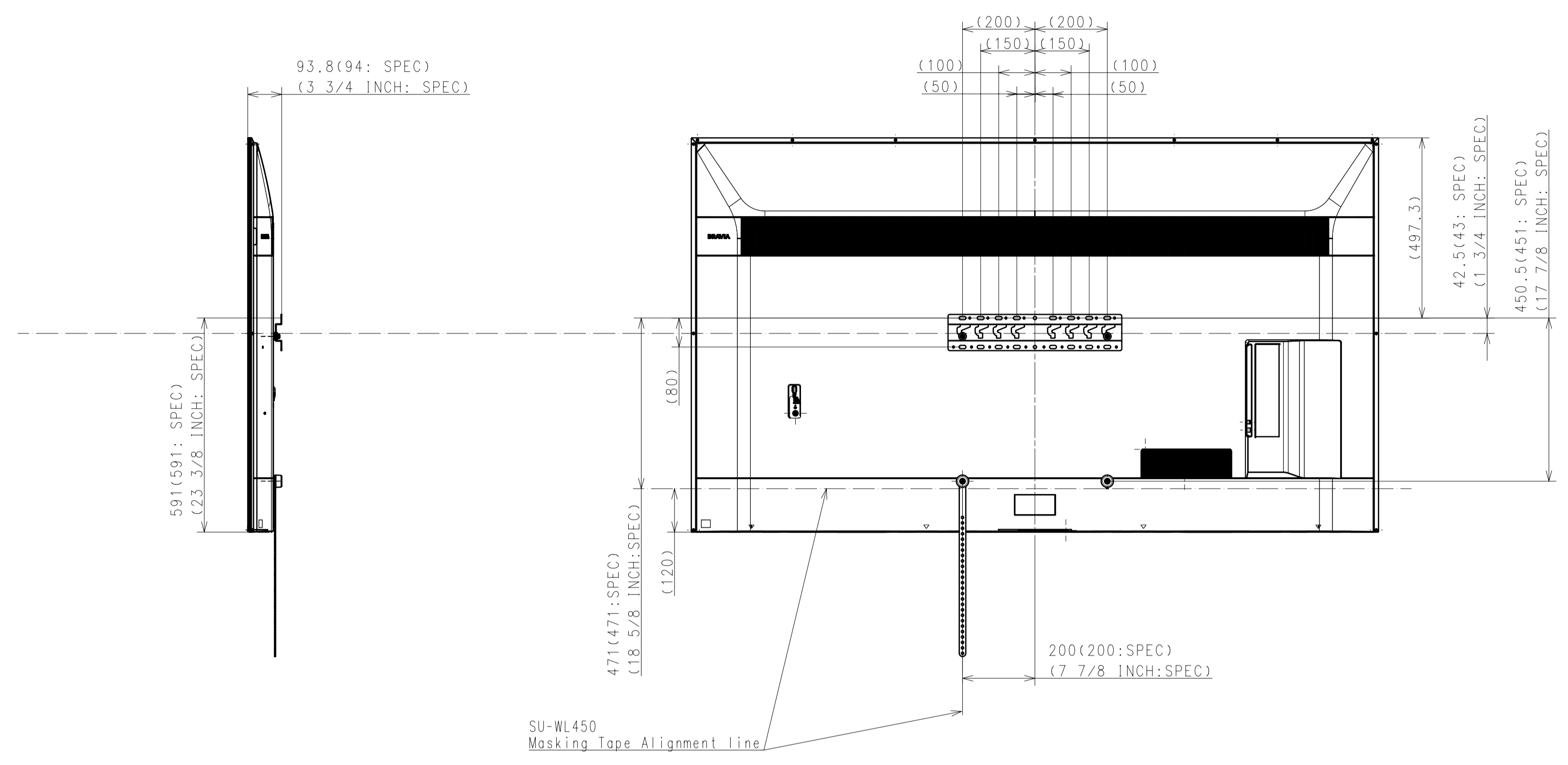

SU\_WL450 STANDARD

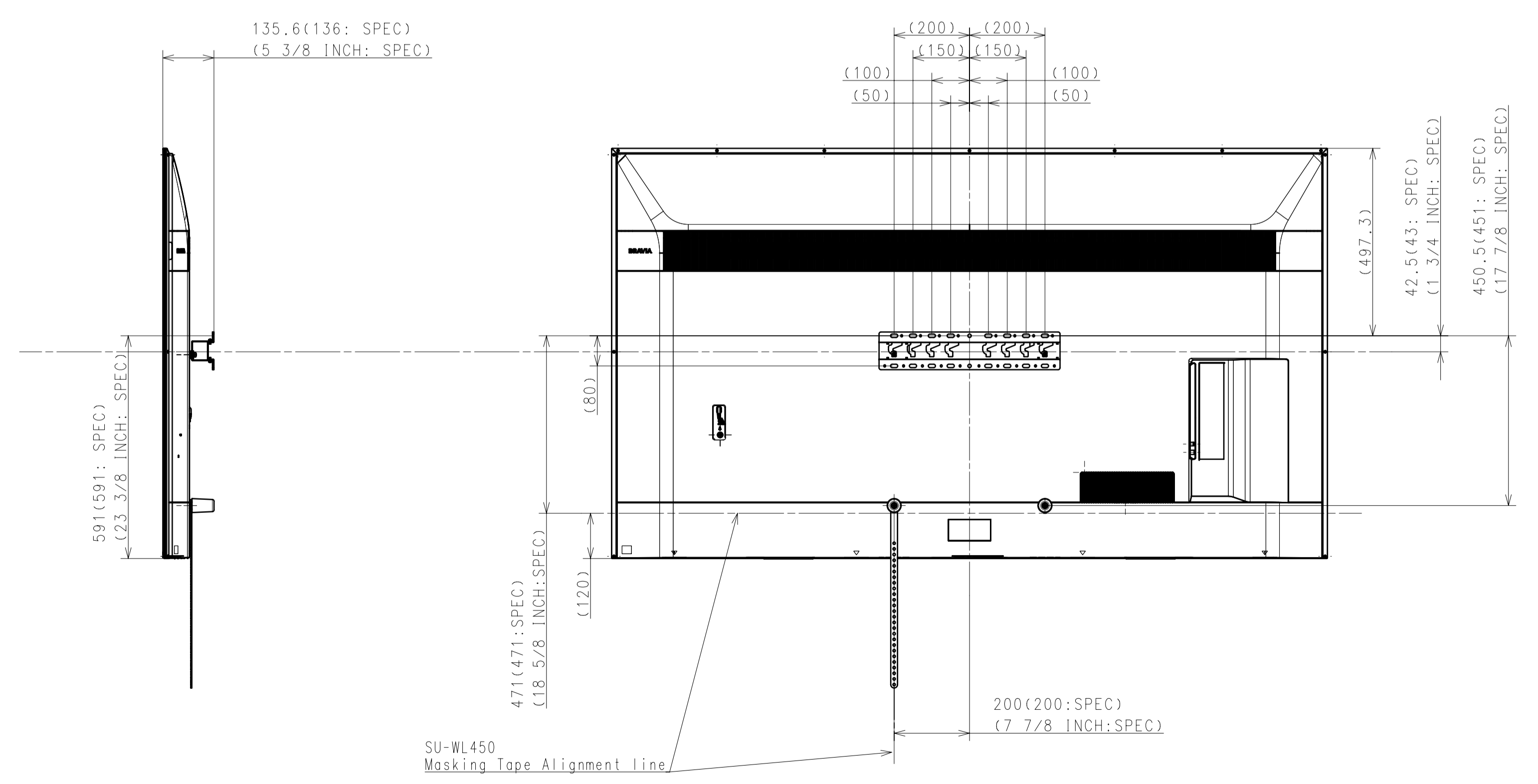

DESCRIPTION:	LEGAL OWNER:	SCALE:
85(BZ40L) EXTERIOR VIEW	Sony Corporation	1:1
DESCRIPTION:	PART NO.:	SHEET/PAGES:
85(BZ40L) EXTERIOR VIEW		3 / 3